

# QST

DEVOTED ENTIRELY TO

# AMATEUR RADIO

PUBLISHED SINCE 1915 BY THE AMERICAN RADIO RELAY LEAGUE INC.

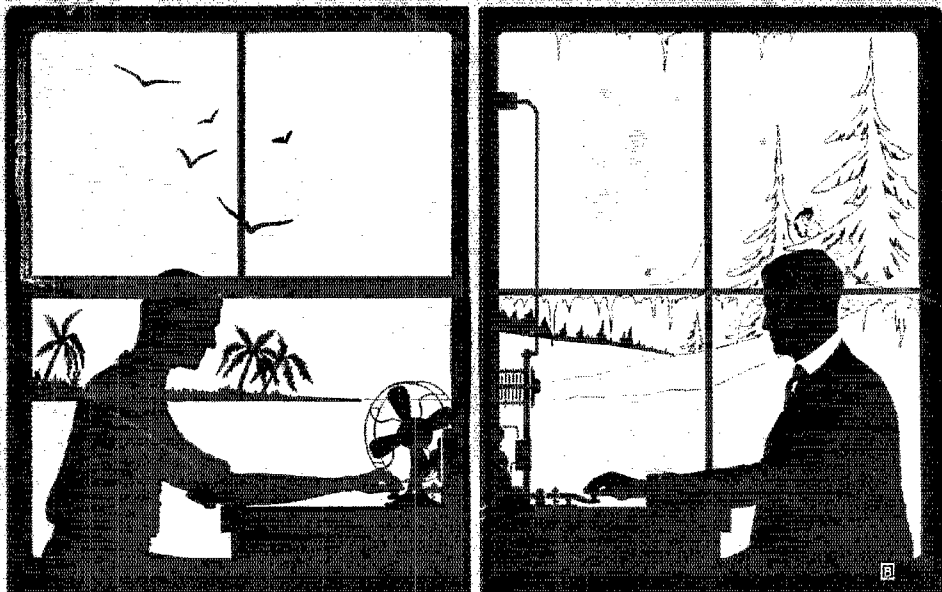

MERRY CHRISTMAS

Dec. 1928

25¢

# General Radio Apparatus

*Is primarily intended for the amateur experimenter*

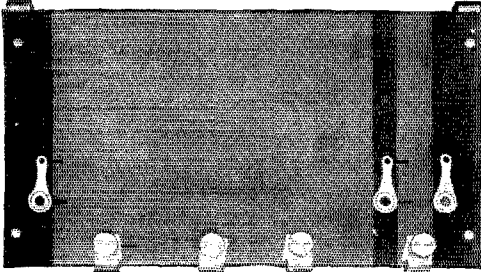

Type 446 Voltage Divider  
Price . . . \$2.75

The Type 446 Voltage Divider is a true output potentiometer device. It is wound in two sections, one of 15,000 ohms primarily intended for a 300 volt rectifying system and a 1,500 ohm section for obtaining the bias voltage of a power tube. It is equipped with four adjustable slides, by means of which any combination of voltage may be obtained. This unit dissipates 60 watts and may be used with a 500 volt rectifying system by connecting two units in series.

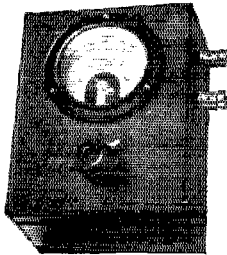

Type 287 Ohmmeter  
Price . . . \$30.00

The Type 287 Direct-Reading Ohmmeter consists of a battery and meter in series with a resistance which protects the meter from damage at short circuit. The dial is calibrated directly in ohms. One of the greatest uses of this ohmmeter is the checking of apparatus. Its indication of the actual resistance of the circuit makes it particularly useful in the laboratory.

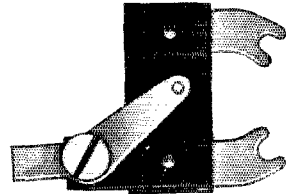

Type 437 Center Tap Resistance  
Price . . . \$0.50

In using alternating current a means of obtaining the mid-potential of the filament is required. The type 437 Center-Tap Resistance is designed to be mounted directly across the filament terminals of any tube socket by means of adjustable contact prongs. This unit provides the center tap of the filament in circuits requiring such a connection. The tap is made by means of an adjustable slide. This unit has a total resistance of 60 ohms and is capable of carrying 200 milliamperes.

## GENERAL RADIO

30 STATE ST.  
CAMBRIDGE, MASS.

274 BRANNAN ST.  
SAN FRANCISCO, CALIF.

## COMPANY

*Bulletin No. 931 Is Now Ready for Distribution*

# SM

## Where Reception Must Not Fail

### — Use S-M

The world knows the story of Goebel and Davis, and how they piloted the monoplane *Woolaroc* to victory and the \$25,000 prize in the Dole flight from San Francisco to Hawaii. But for the radio fan there's another thrill in the dramatic story of the radio beacons which guided these planes—of fading beacon signals; of a tube held by the navigator for two hours in a broken socket, until land

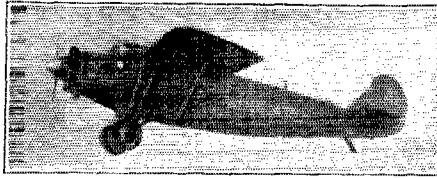

was sighted on the island of Maui. But the S-M plug-in coils that formed the basis of the *Woolaroc's* receiver *did not fail*.  
Read the particulars of this historic-making flight, as graphically described in the I.R.E. "Proceedings" for September by Clayton C. Shangraw of Wright Field, with photographs of the *Woolaroc's* receiver built around familiar and dependable S-M plug-in coils.

## S-M "Round-the-World" Short Wave Kits

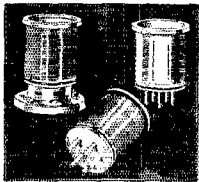

### New S-M Coils

New S-M 131-type moulded bakelite coils, used in 730 sets, fit any standard 5-prong tube socket. Four coils in kit cover 17 to 200 meters; two extra coils now available cover the broadcast band also: 131X, 190-360 m. \$1.25 131Y, 350-650 m. 1.50

Your television experiments and short wave reception—do you depend on a receiver which is itself of "experimental" construction and requires excessive attention to insure reliability and time to change wave lengths? If you own an S-M "Round-the-World" Receiver, in its neat aluminum shielding cabinet, with its screen grid r.f. stage and quick-action plug-in coils, you can rest assured your reception—whether code, voice, or pictures—interstate or international—will be top-notch *all the time*.

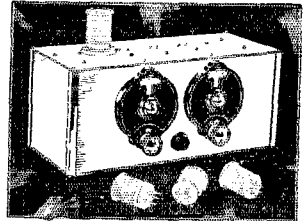

### Complete Kit

Everything necessary to build the complete four tube r.f. regenerative (non-radiating) short-wave set, including aluminum cabinet and two S-M Clough audio transformers.  
730 Complete Kit.....\$51.00  
730 Set, Wired..... 66.00

### Adapter Kit

Complete with aluminum cabinet, less the two audio stages. Used with an adapter plug, it converts any broadcast receiver for short-wave use. Ideal for Television.  
731 Adapter Kit.....\$36.00  
731 Adapter, Wired.....46.00

### Essential Kit

Contains the two tuning and tickler condensers, four wound plug-in coils, coil socket, and three r.f. chokes, with full instructions for building a 1, 2, 3, or 4 tube set.  
732 Essential Kit.....\$16.50

## You Can Give S-M Tone Quality to Any Set with S-M Clough Audios

S-M Clough-system audio transformers are guaranteed unconditionally to give better tone quality than others, with *higher amplification*, regardless of size, weight, or price. They sell in tremendous quantities, by simply comparing results with

others in the *comparison amplifiers* used in S-M demonstrations at recent radio shows. They are made in two sizes: S-M 225, 1st stage, and 226, last stage, are \$9.00 each; S-M 255, 1st stage, and 256, last stage, are \$6.00 each.

Are you receiving "The Radiobuilder" regularly? No. 5 (Sept.) described a Comparison Amplifier for comparing audio transformers. No. 6 (Oct.) told about the new "PA" Public Address System. To S-M Authorized Service Stations, it comes free of charge, with all new constructional Data Sheets. If you build professionally, write us about the Service Station franchises.

**SILVER-MARSHALL, Inc.,** 858 W. JACKSON BLVD. CHICAGO, ILL. U. S. A.

Silver-Marshall, Inc.  
858 W. Jackson Blvd., Chicago, U. S. A.

...Send your complete catalog, with sample copy of the Radiobuilder.

...For enclosed 2c stamp, send Data Sheet No. 3 on Short Wave Sets.

Name.....

Address.....

# Safeguard Your A. C. Installation!

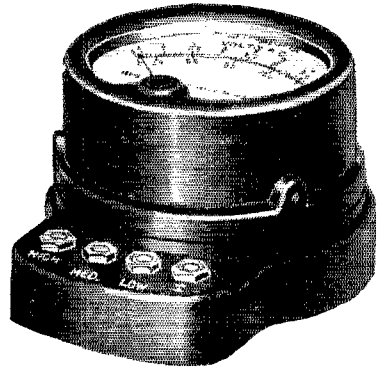

**S**ATISFACTORY and economical operation of A. C. receivers is contingent upon maintaining close regulation of operating voltages, by means of suitable A. C. measuring instruments. This is necessary because of the wide fluctuation in the potential of secondary lines furnishing current to house lighting circuits.

Set manufacturers, dealers and electric light and power companies everywhere are cooperating to the end that voltage regulation, both on supply lines and in connection with voltage control equipment of the receivers themselves, may be effected for the better operating service of all set owners. For this reason, as well as for other testing requirements outlined in the following, all purchasers of A. C. receivers are urged to provide themselves with an instrument such as is shown in the illustration—known as the Weston Model 528 A. C. Voltmeter, range 150-8-4 volts.

When you find that there is an

excessive input voltage, it follows that there is too high a voltage on the filament which shortens the operating life of the rectifying tubes. The Model 528 Voltmeter therefore checks the line supply voltage at all times and indicates when adjustments should be made to manually operated line voltage regulators between the power supply and the power transformer.

This voltmeter also indicates when the line voltage is over-rated, thus enabling the operator to make an adjustment in the set for the higher line voltage so that normal life can be obtained from his tubes.

The Model 528 is also made as Ammeters which are especially useful in checking the total load of the A. C. Set—in conformity with set manufacturers' instructions. The determination of A. C. filament flow in A. C. tube filament circuits is easily obtained by means of this instrument.

## **WESTON RADIO INSTRUMENTS**

*Write for your copy of Circular J fully  
describing the Weston Radio Line*

**WESTON ELECTRICAL INSTRUMENT  
CORPORATION**  
602 Frelinghuysen Avenue  
Newark, N. J.

# Section Communications Managers of THE COMMUNICATIONS DEPARTMENT, A. R. R. L.

Eastern Pennsylvania	W3QP	J. B. Morgan, 2nd	431 E. Willow Grove Ave.	Chestnut Hill, Phila.
Maryland-Delaware-District of Columbia	W3AIS	Dr. H. H. Layton	805 Washington St.	Wilmington, Del.
Southern New Jersey	W3CFG	M. J. Letysh	Box 49, RFD 1	Cranbury, N. J.
Western New York	W8PJ	C. S. Taylor	598 Masten St.	Buffalo
Western Pennsylvania	W8CEO	A. W. McAuly	309 Third St.	Oakmont
<b>ATLANTIC DIVISION</b>				
Illinois	W9APY	Fred J. Hinds	5337 Oak Park Blvd.	Berwyn
Indiana	W9CYQ	D. J. Angus	510 N. Illinois St.	Indianapolis
Kentucky	W9BAZ	J. B. Waihen, III	Box 97, R. F. D. 1	Louisville
Michigan	W8CEP	Dallas Wise	9187 Falcon Ave.	Troy
Ohio	W8RYN	H. C. Stork	634 Carpenter St.	Columbus
Wisconsin	W9VD	C. N. Crano	143 Newton Ave.	Milwaukee
<b>CENTRAL DIVISION</b>				
North Dakota	W9DYV	R. S. Warner	399 4th Ave.	Enderlin
South Dakota	W9DGR	D. M. Fausck	730 Illinois St.	Huron
North Minnesota	W9BVH	Carl L. Jabs	1822 James St.	St. Paul
South Minnesota	W9RYA	D. F. Cottam	3538 Third Ave. So.	Minneapolis
<b>DAKOTA DIVISION</b>				
Arkansas*	W5ABI	H. E. Vette	5408 U St.	Little Rock
Louisiana	W5TK	C. A. Freitag	129 Camp St.	New Orleans
Mississippi	W5AKP	J. W. Gullett	1708 23rd Ave.	Meridian
Tennessee	W5FT	Polk Purdue	10 Radio Station WBAV	Nashville
<b>HUDSON DIVISION</b>				
Eastern New York	W2CNS	F. M. Holbrook	2 Livingston Ave.	White Plains
N. Y. C. & Long Island	W2KR	M. B. Kahn	817 W. 141st St.	N. Y. C.
North New Jersey	W2WR	A. G. Wester, Jr.	50 Princeton St.	Maplewood
<b>MIDWEST DIVISION</b>				
Iowa	W9DZW	H. W. Kerr		Little Sioux
Kansas	W9CET	J. H. Anis	915 Lincoln Ave.	Toneka
Missouri	W9RR	L. B. Lutzore	8010 Mercer St.	Kansas City
Nebraska	W9BYG	C. B. Deihl	5905 Cedar St.	Omaha
<b>NEW ENGLAND DIVISION</b>				
Connecticut	W1ZL	C. A. Weldenhammer	33 Washington Place	Bridgeport
Maine	W1B1G	Frederick Best	13 E. Crescent St.	Augusta
Eastern Massachusetts	W1UE	E. L. Battey	39 Royal St.	Wollaston
Western Massachusetts	W1UM	Dr. John A. Tessmer,	8 Schaffner St.	Worcester
New Hampshire	W1ACT	V. W. Rodge	227 Main St.	Concord
Rhode Island	W1ECP	C. N. Kniss	92 Keene St.	Providence
Vermont	W1VT	Clayton Paulette		North Troy
<b>NORTHWESTERN DIVISION</b>				
Alaska	W9WDN	W. B. Wilson	U. S. L&T Fern	Ketchikan
Idaho	W7ACN-7JL	James L. Young	303 13th Ave. So.	Idaho Falls
Montana	W7AAZ-7QV	O. W. Vters		Red Lodge
Oregon	W7PP	R. H. Wright	310 Ross St.	Portland
Washington	W7FD	Otto Johnson	4340 30th Ave. W.	Seattle
<b>PACIFIC DIVISION</b>				
Hawaii	K6CFQ	F. L. Fullaway	2714 Manoa Rd.	Honolulu
Nevada	W6FO	C. B. Newcombe		Yerington
Los Angeles	W6AM	D. C. Wallace	199 W. Third St.	Long Beach Calif.
Santa Clara Valley	W6NX	F. J. Quement	252 Hanchett Ave.	San Jose
East Bay	W6CZR	J. Walter Frates	368 82nd St.	Oakland
San Francisco				
Sacramento Valley	W6CRS	C. F. Mason	2530 N. St.	Sacramento
Arizona	W6ANO	D. B. Lamb	229 W. First St.	Mesa
Philippines*	9PLAT	Jose E. Jimenez	535 San Fernando St.	Manila
San Diego	W6BQ	G. A. Sears	236 Bonair St.	La Jolla
<b>ROANOKE DIVISION</b>				
North Carolina	W4SJ	Enno Schuelke	R. F. D. No. 1	Ridgeway
Virginia	W3CA	J. F. Wohlford	118 Cambridge Ave.	Roanoke
West Virginia	W8HD	C. S. Hoffman	126 Chantal Court	Wheeling
<b>ROCKY MOUNTAIN DIVISION</b>				
Colorado	W9CAA	C. R. Stedman	1641 Albion St.	Denver
Utah-Wyoming	W6BAJ	Parley N. James	430 "D" St.,	Salt Lake City
<b>SOUTHEASTERN DIVISION</b>				
Alabama	W4AHO	A. D. Trum	217 Catoma St.	Montgomery
Florida	W4LK	C. E. Ffoulkes	502 Spearing St.	Jacksonville
Georgia-South Carolina-Cuba-Porto Rico-Isle of Pine	W4KU	H. L. Reid	1 Shadownawu Ave.	Atlanta
<b>WEST GULF DIVISION</b>				
Northern Texas	W5AKN	J. H. Robinson, Jr.	522 Cumberland St.	Dallas
Oklahoma	W5AMO	Henn Morgan	753 Asp Ave.	Norman
Southern Texas	W5OX	R. E. Franklin	1806 Valentine St.	Houston
New Mexico	W5TP	L. E. Radka		Tucumanari
<b>MARITIME DIVISION</b>				
Newfoundland	VE8AR	Loyal Reid	Avalon House	St. Johns
New Brunswick	VE1E1	T. B. Lacey	c/o N. B. Power Co.	St. John
Nova Scotia	VE1DD	W. C. Borrett	14 Sinclair St.	Dartmouth
Prince Edward Island	VE1BZ	P. W. Hyndman	25 Fitzroy St.	Charlottetown, P. E. I.
<b>ONTARIO DIVISION</b>				
Ontario	VE3FC	E. C. Thompson	266 Queensdale Ave.	Toronto, 6
<b>QUEBEC DIVISION</b>				
Quebec	VE2BE	Alex Reid	169 Logan Ave.	St. Lambert
<b>VANALTA DIVISION</b>				
Alberta	VE4HA	E. J. Taylor	10107-87th Ave.	Edmonton
British Columbia	VE5BJ	E. S. Brooks	2987 Camosun St.	Vancouver
<b>PRAIRIE DIVISION</b>				
Manitoba	VE4FV	D. B. Sinclair	205 Cambridge St.	Winnipeg
Saskatchewan	VE4FC	W. J. Pickering	514 19th St. W.	Prince Albert

\*Temporary officials appointed to act until the membership of the Section concerned choose permanent SCMs by renomination and election.

now

# America's Sensational Distance Getter At a New Low Price

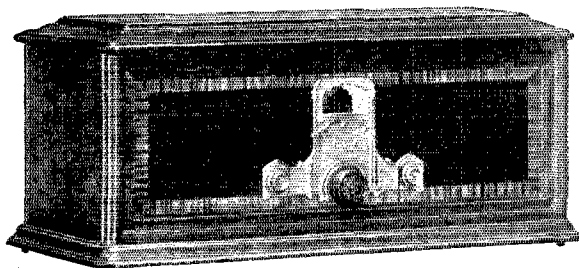

WITH price reductions on the entire line of Federal Radios — America's Finest in every class—comes a reduction in the price of the Federal F11, from \$250 to \$145, for the battery model, from \$360 to \$220, for the 60 cycle light-socket model, and from \$380 to \$245 on the 25 cycle model.

The Federal F11 is beyond question America's most sensational D. X. receiver. Antenna-ground operation with four stages of tuned radio frequency, detector and two stages of amplification, combined with the most precise engineering standards known in the industry, give delicate hair-line tuning with extreme sensitivity to the weakest of signals picked up by the Antenna. The Federal F11 has dramatically demonstrated its remarkable distance getting powers wherever tested.

Ask the Designated Federal Retailer in your community to demonstrate this phenomenal receiver or write direct for complete specifications.

*Federal prices do not include tubes  
and are slightly higher west of Rockies.*

**FEDERAL RADIO CORPORATION, BUFFALO, N. Y.**  
OPERATING BROADCAST STATION WGR AT BUFFALO  
Federal Ortho-sonic Radio, Ltd., Bridgeburg, Ont.

## Remarkable Federal Feats

Verified reception time and time again at Buffalo, N. Y., of such stations as JOAK, Tokyo, Japan, 2Lo, London, England, and PWX, Havana, Cuba, gives dramatic evidence of the powers of the Federal F11.

# Federal ORTHO-SONIC\* Radio

Licensed under patents owned and or controlled by Radio Corporation of America, and in Canada by Canadian Radio Patents Ltd.

\* Federal's fundamental exclusive development making possible Ortho-sonic reproduction is patented under U.S. Letters Patent No. 1,522,170

Say You Saw It In QST — It Identifies You and Helps QST

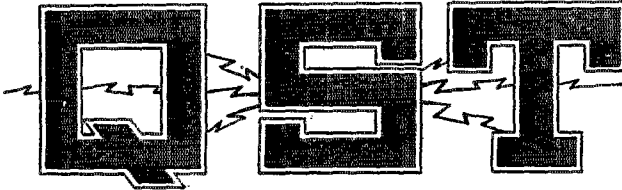

# The Official Organ of the A.R.R.L.

VOLUME XII

DECEMBER 1928

NUMBER 12

Editorials	7
The "Good Old Days"	8
Station Descriptions for 1929	8
The Construction and Operation of a 3500-kc. Crystal-Controlled Phone	Earl W. Springer 9
Push-Pull Transmitters	James J. Lamb 13
Radio With the Byrd Expedition	17
An Improved Superheterodyne	J. M. Grigg 23
Straight-Edge Solutions	26
Remote Control Relay	Gordon Fixman 28
Choke Coil Design	Herbert F. Waring 23
Debunking Crystal Control	J. Herbert Hollister 35
Regenerative Coupling Devices in Audio Amplifiers	J. K. Clapp 37
Relieving the Glass Arm	Charles A. Hill 40
A Frequency Meter Combined with Your Receiver	Eugene C. Woodruff 41
Some Suggestions for the Monitor	George Grammer 43
Now—the Vacuum Tube Ammeter	L. W. Harry 44
Experimenters Section Report	46
Calls Heard	50
I.A.R.U. News	51
Correspondence Department	52
Financial Statement	80
Some Election Returns	90

QST is published monthly by The American Radio Relay League, Inc., at Hartford, Conn., U. S. A. Official Organ of the A.R.R.L. and the International Amateur Radio Union

Kenneth B. Warner (Secretary, A.R.R.L.),  
Editor-in-Chief and Business Manager

F. Cheyney Beekley,  
Managing Editor and Advertising Manager

Harold P. Westman,  
Technical Editor

Ross A. Hull,  
Associate Technical Editor

David H. Houghton,  
Circulation Manager

Subscription rate in United States and Possessions, Canada, and all countries in the American Postal Union, \$2.50 per year, postpaid. Single copies, 25 cents. Foreign countries not in American Postal Union, \$5.00 per year, postpaid. Remittances should be by international postal or express money order or bank draft negotiable in the U. S. and for an equivalent amount in U. S. funds. Entered as second-class matter May 29, 1919, at the post office at Hartford, Connecticut, under the act of March 3, 1879. Acceptance for mailing at special rate of postage provided for in section 1103, Act of October 3, 1917, authorized September 9, 1922. Additional entry as second-class matter, acceptable at special rate of postage provided for above, at Springfield, Mass., authorized September 17, 1924.

Copyright 1928 by the American Radio Relay League, Inc. Title registered at United States Patent Office.  
Member of the Radio Magazine Publishers' Association.

# The American Radio Relay League

The American Radio Relay League, Inc., is a non-commercial association of radio amateurs, bonded for the promotion of interest in amateur radio communication and experimentation, for the relaying of messages by radio, for the advancement of the radio art and of the public welfare, for the representation of the radio amateur in legislative matters, and for the maintenance of fraternalism and a high standard of conduct.

It is an incorporated association without capital stock, chartered under the laws of Connecticut. Its affairs are governed by a Board of Directors, elected every two years by the general membership. The officers are elected or appointed by the Directors. The League is non-commercial and no one commercially engaged in the manufacture, sale or rental of radio apparatus is eligible to membership on its board.

"Of, by and for the amateur", it numbers within its ranks practically every worth-while amateur in the world and has a history of glorious achievement as the standard-bearer in amateur affairs.

Inquiries regarding membership are solicited. A bona fide interest in amateur radio is the only essential qualification; ownership of a transmitting station and knowledge of the code are not prerequisite. Correspondence should be addressed to the Secretary.

## DIRECTORS

*President*  
HIRAM PERCY MAXIM  
Drawer 2102,  
Hartford, Conn.

*Vice-President*  
CHARLES H. STEWART  
St. David's, Pa.

*Canadian General Manager*  
A. H. K. RUSSELL  
5 Mail Bldg.,  
Toronto, Ont.

*Atlantic Division*  
DR. EUGENE C. WOODRUFF  
234 W. Fairmount Ave.,  
State College, Pa.

*Central Division*  
CLYDE E. DARR  
137 Hill Ave., Highland Park,  
Detroit, Mich.

*Dakota Division*  
C. M. JANSKY, JR.  
Dept. of Elec. Eng., U. of M.,  
Minneapolis, Minn.

*Delta Division*  
BENJ. F. PAINTER  
424 Hamilton Nat'l Bank Bldg.,  
Chattanooga, Tenn.

*Hudson Division*  
DR. LAWRENCE J. DUNN  
80 Hanson Place  
Brooklyn, N. Y.

*Midwest Division*  
PORTER H. QUINBY  
817 Lauderman Building,  
St. Louis, Mo.

*New England Division*  
DR. ELLIOTT A. WHITE  
Dartmouth College,  
Hanover, N. H.

*Northwestern Division*  
E. W. WEINGARTEN  
3219 No. 24th St.,  
Tacoma, Wash.

*Pacific Division*  
ALLEN H. BABCOCK  
65 Market St.,  
Southern Pacific Co.,  
San Francisco

*Ryanoke Division*  
W. TREDWAY GRAVELY  
Box 245,  
Danville, Va.

*Rocky Mountain Division*  
PAUL M. SEGAL  
Box 1771  
Denver, Colo.

*Southeastern Division*  
HARRY F. DOBBS  
Harry F. Dobbs, Inc.  
245 Spring St., N. W.,  
Atlanta, Ga.

*West Gulf Division*  
FRANK M. CORLETT  
2515 Catherine St.,  
Dallas, Tex.

## OFFICERS

*President* . . . . . HIRAM PERCY MAXIM, Hartford, Conn.  
*Vice-President* . . . . . CHAS. H. STEWART, St. David's, Pa.  
*Secretary* . . . . . KENNETH B. WARNER, Hartford, Conn.  
*Treasurer* . . . . . ARTHUR A. HEBERT, Hartford, Conn.  
*Communications Manager* . . . F. EDWARD HANDY, Hartford, Conn.



# EDITORIALS

THE International Amateur Radio Union has adopted a new constitution whereunder it becomes an international federation of independent national amateur societies like our A.R.R.L. Thus at length there is consummated that dream of many years, a true international amateur body to deal with the international aspects of our amateur radio, a dream never capable of realization while the Union continued as a single world-wide association of individual memberships. Progress has been slow in the development of the federation from the association formed at Paris in 1925, with many difficulties to negotiate and many differences of opinion to reconcile, but at last it has been done. While in 1925 such a union was impossible because national societies of bona-fide transmitting amateurs did not exist in many countries, the probationary period in the Union's existence has resulted in many cases in the establishment of those strong societies as outgrowths of the Union's original "sections", and so the time has by no means been wasted.

The new constitution is printed in this month's I.A.R.U. department in *QST*. Every amateur ought to read it and know for what the Union stands and how it operates. Amongst its purposes are "the promotion and coördination of two-way radio communication between the amateurs of the various countries of the world; the effecting of coöperative agreements between the national amateur radio societies of the various countries of the world on matters of common welfare; the advancement of the radio art; the representation of two-way amateur radio communication interests in international communication conferences; the encouragement of international fraternalism." It will not concern itself with the domestic affairs of any society but exists for the purpose of smoothing out our international difficulties and applying to the radio relations of amateurs in different countries that same brand of practical coöperation which we have found so essential in our national affairs.

League members who recall the list of countries in which the Union, in its original form, had "sections", will be pleasantly

surprised to read the present membership roster of the I.A.R.U.: American Radio Relay League, *Asociacion E. A. R.* (Spain), *Associazione Radiotecnica Italiana* (Italy), Canadian Section A.R.R.L., *Deutscher Funk Technischer Verein* (Germany), *Nederlandsche Vereeniging voor Internationaal Radioamateurisme* (Netherlands), Radio Society of Great Britain, *Reseau Belge* (Belgium), *Reseau des Emetteurs Francais* (France), South African Radio Relay League, Wireless Institute of Australia, plus sections not yet converted into fully-fledged independent societies in Argentina, Brazil and Switzerland. Negotiations are under way now to bring into membership the amateur societies in Norway, Poland and Portugal. Other societies are invited to apply. The A.R.R.L. has been named as the headquarters member, and the A.R.R.L.'s president, vice-president and secretary occupy their respective offices in the Union.

This, then, is the international machinery which the amateur has set up for the expansion and the safe-guarding of his activities everywhere. Like our League it is "of, by and for the amateur"—the two-way communicating amateur—and non-commercial. International amateur communication, so precious to us, so vital a force in the flowering of friendships and in the creation of that common understanding between peoples which is the best guarantee of peace and happiness, will encounter many problems on which coöperation between national societies will be necessary. Particularly will this be true when the provisions of the Washington Convention take effect. No one national society can dictate what all amateurs must do. Nobody would pay attention. Yet there must be orderly discussion, the weighing of problems, and orderly solutions mutually determined, or our international contact will suffer. We need the I.A.R.U. It will act as the medium between societies to effect that vital coöperation.

The rehabilitation of the Union at this time is a splendid thing for all of us. It is a strong point in the amateur's preparation to take care of himself in the changing con-

ditions and amongst the manifold difficulties which 1929 ushers in. Its principles we know are sound, because they are unselfish and because they have been tested for years in A.R.R.L. and every other successful amateur association. It will work well for us,

not only in the solution of practical operating problems but in hastening that day when in every country of the world there is contact and understanding between its people and those of other lands.

K. B. W.

## The "Good Old Days"

**T**HERE seems to be a pretty definite feeling among hams today that the old game has changed within the last few years from the friendly rag-chewing state that characterized it some time ago.

One ham writes as follows:

"It seems to me as if amateur wireless telegraphy is being put too much on a business basis. It seems as if the fellows who do not have messages to get thru are out of the game.

"If I answer a station, the first thing he asks is QRU. If I say NIL, then it's '73' for me. I don't even have a chance to QRA him.

"Where is the fellow who calls his pal in another State and says 'How is the weather?' or 'How does the world treat you?' There are very few of those fellows around."

Now, brother hams, just when was this letter written? Recently? Not so you would notice it! It was written nearly nine years ago, at the hey-day of the spark, and the "good old days" of yore, when J. O. Smith was the Traffic Manager of the League and a transcon needed at least two relays to get across the country. It was written by Hutchinson, 9HR, in March,

1920, and published on page 47 of the *QST* of May, 1920.

Apparently, the game has not changed so much. We still kick about the same things.

## Station Descriptions for 1929

**T**HERE have been a great snag of queries as to why station descriptions have been missing from *QST* during the last few months. In explanation we have said that stations are described in the magazine to provide examples of the best practice for the aid and inspiration of station builders—or re-builders—and that early 1928 type stations, except in rare cases, are not examples of what is considered the best practice for 1929. At this time, however, 1929 type stations are being evolved in hordes and the material for a series of station descriptions in next year's *QST*'s undoubtedly exists in abundance. Who is to start off the new series of true 1929 type stations?

Sharp photographs of postcard size or larger are desirable together with a description in detail of all circuits and apparatus.

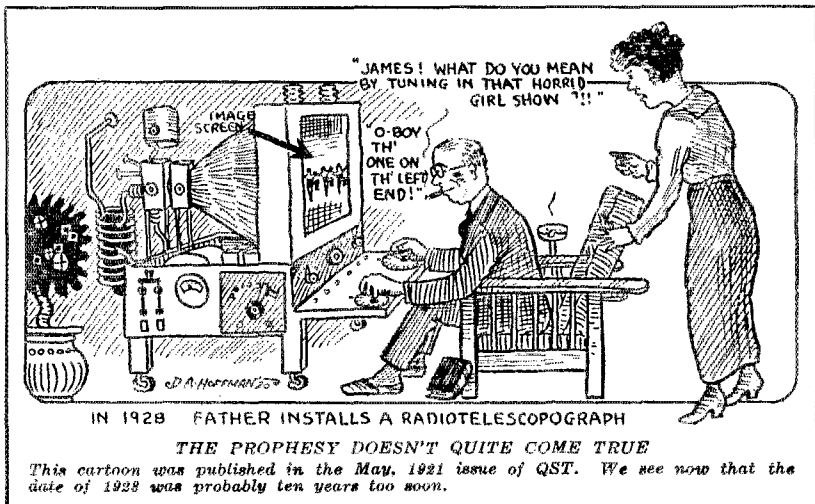

# The Construction and Operation of a 3500-kc. Crystal-Controlled Phone

By Earl W. Springer\*

**I**N VIEW of the fact that the frequency band from 3500 to 3550 kc. is available for phone work, a number of amateurs are getting phones on the air. About half of them successfully hit the correct frequencies and stay there.

If we just stop to think, 50 kc. is really a very narrow range in which to work and for phone transmission there is only room for five stations to operate without interference if they were separated by a frequency of 10 kc. However, it has been my experience that five amateur phones of the average loop modulation type couldn't get into a frequency band of 50 kc. and work without interference even if their carrier frequencies were 10 kc. apart, for just as soon as modulation is impressed, wobulation starts up, and the said phones can be found covering 15 kc. or more with the addition of a 5 to 10 kc. shift in frequency as the tubes warm up.

I have been using a screen-grid r.f. receiver for 3500-kc. phone work and I find with this receiver that tuning is rather sharp, cutting off quickly at somewhere near 10 kc. Some of the phones I pick up appear to have very poor modulation, yet when the r.f. stage is detuned, the detector alone being used, the modulation clears right up. In other words the wave being picked up is wobbling so much due to modulation that the r.f. stage cuts off that portion of the signal which shifts more than 10 kc. from the frequency setting of the receiver.

A signal that is covering up a large frequency range by modulation wobble cannot expect to be as effective as a signal maintaining a constant frequency, and having all side bands generated by modulation alone. The whole problem has a parallel in the "shotgun and the rifle" as mentioned in QST some time ago.

In the shotgun example, several ounces of powder are used to force a number of small shot over a large area covering a short distance. The man using such a gun doesn't have to be a good shot to hit the target, for he can bang away in the general direction of the mark and expect to score somewhat of a hit providing, of course, the

target is within the range of the shot. The distance covered in any case is never great.

Now let us take for our example, the rifle. With only a very small amount of powder, a single ball is shot a long distance with great speed and force. To hit the target, however, good aim must be exercised.

Radio transmission is just the same way, it seems. The broad transmitter is easy to tune in but is neither able to cut through interference nor cover distance with the same effectiveness as the transmitter radiating all its energy within a narrow frequency band.

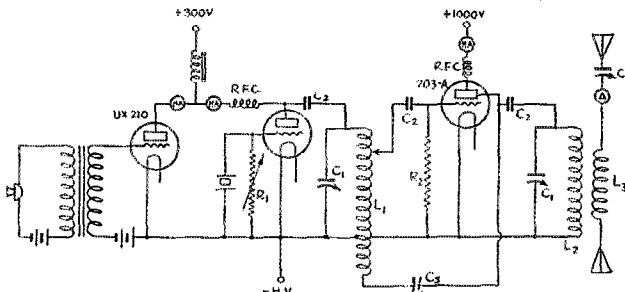

FIGURE 1. HEISING MODULATION IS APPLIED TO THE CRYSTAL OSCILLATOR. THE AMPLIFIER IS NEUTRALIZED TO PREVENT SELF-OSCILLATION

- C1. 250- $\mu$ fd. receiving condenser.
- C2. 250- $\mu$ fd. fixed condenser.
- C3. 250- $\mu$ fd. receiving condenser double spaced.
- L1. 25 turns of No. 18 d.c.c. wire on a 3 1/2" form.
- L2. 1.5. 12 turns of 1/4" ribbon 4" in diameter.
- L3. 30-henry choke.
- R1. Bradleyeak.
- R2. 2,500 ohms.
- RFC 150 turns of No. 30 d.c.c. on a 1" form.

The object was, then, to design and construct a transmitter that would do the rifle act for radio transmission and not the shotgun one as most transmitters do.

There are two types of transmitters that will do this; these being the master oscillator type and the crystal controlled type.<sup>1</sup> Better results are obtainable with crystal control, and wave shifting due to tubes warming up does not take place, while the master oscillator, power amplifier set, unless the oscillator is materially under-loaded will have some slight shift. Because of its greater stability, the crystal was chosen.

The next question was the manner in which the carrier would be modulated. Two methods were tried, both working out well. The first method tried was to modulate the

1. Both of these are oscillator-amplifier transmitters and differ chiefly in that one employs a crystal to determine the frequency while the other does not.

\*WBW1, R. R.—Fort Wayne, Ind.

crystal oscillator. As will be seen in Figure 1, the Heising constant current, system was employed.

Using this circuit, as high an r.f. voltage cannot be placed on the grid of the amplifier tube as for c.w. operation because voltage peaks caused by modulation must be allowed for. When too high an excitation is used, the amplifier plate current will drop back when modulation is impressed. The

"C" battery is used it is necessary to use an r.f. choke with a natural period somewhere near the frequency of the crystal. If the choke happens to be too near the frequency of the crystal, it may wreck it due to forced oscillation, should any feedback occur from the amplifier. When only the resistance is used, even if the amplifier does get out of neutralization, it will not have near the regenerative effect on the crystal oscillator as when the "C" battery and choke method is used. Still one other advantage of the resistance is that the oscillator cannot operate unless the crystal oscillates, and it is therefore impossible to have an input to the amplifier at any other than the crystal frequency.

The second method employed was to modulate the amplifier stage by the Heising system. A modulator tube of the same rating as the amplifier tube was used. With this system, it is possible to run the excitation voltage applied to the grid of the amplifier up to the value that would be used for c.w. operation because no modulation peaks will be impressed upon the grid of the amplifier stage. It is thus possible to get somewhat greater output with this method. The circuit is shown in Figure 2.

Most phone operators do not pay enough attention to the audio amplifiers used and distortion occurs in either the speech amplifier or modulator tubes. Under no conditions should the plate current to these amplifier tubes vary when modulation is taking place.

Let us refer to a sample characteristic curve showing the effect of grid voltage upon plate current for the standard type of vacuum tube. This is shown in Figure 3.

Assume the characteristic curve x-y for a given plate voltage. Locate the operating point of the tube at b by using a high negative grid bias. When the wave form of voltage indicated by the dotted line is impressed on the grid the resultant plate current wave form will be produced as shown by the graphic construction. It is easily seen that the area of the loop above the line b-c is much greater than the area of loop below the line. From this we conclude that the sum of the areas of any number of loops above the line b-c will be greater than the sum of the areas of the loops below the line. This condition results in an increased d.c. plate current when the operation point of the tube is at b, and a signal is impressed upon the grid.

Using the same construction as for operation at point b, point a is located at the center of the slope of the characteristic curve by decreasing the bias to about 25

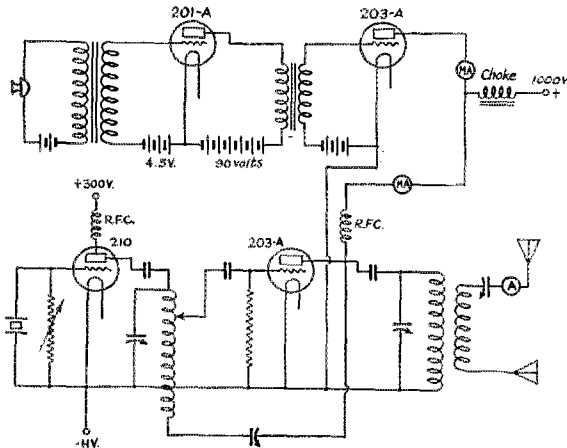

FIGURE 2. IN THIS CASE THE AMPLIFIER TUBE IS MODULATED

The upper two tubes comprise the speech amplifier and modulator while the lower two are the crystal oscillator and r.f. amplifier. The constants are approximately the same as given in Figure 1 and are, therefore, not repeated here.

proper location of the amplifier grid clip on the oscillator inductance is that point where the amplifier plate current remains fairly constant, when modulating. In actual operation this plate current jerked back and forth somewhat while modulation was going on. The antenna current will usually drop back a small amount when modulation is impressed although points of adjustment of the oscillator and amplifier with rather low plate inputs may be found where upward modulation of the antenna current takes place. However, whether the antenna current falls off or increases using this system, it seems to make little difference. The main thing to keep in mind is to have the plate currents of all tubes remain constant when modulation takes place if nearly perfect modulation is wanted.

It was found that a Bradley leak was fine for the grid leak of the oscillator and for highest percentage of modulation of the oscillator a rather high resistance value of grid leak was necessary. The variable adjustment makes it possible to quickly adjust for highest output.

In the oscillator, the use of a grid leak seemed to be much better than the "C" battery for the following reasons: When

volts. Under these conditions when an a.c. voltage is applied to the grid, a wave form of plate current shown by the solid line will be produced. From the figure it is easily seen that the areas above and below the line a-d are equal to each other, and the d.c. plate current of the tube will be neither increased nor decreased by the application of a signal to the grid.

However, even though the bias may be adjusted so that the tube is being operated at the straight portion of the curve, it is possible to cause distortion by making the input voltage too high. When this occurs, the plate current is cut off completely (or very nearly) when the grid is negative and the grid goes positive on the other half of the cycle and draws current. When the overload is slight, the quality is poor and the voice sounds blurred and mushy. Under bad conditions, the voice may be unintelligible.

When overloading is present, it is not always indicated by a change in plate current and the best test is to insert a low reading d.c. milliammeter in the grid circuit to indicate when grid current is being taken by the tube. If no grid meter is available and though the plate current remains constant, the output is distorted; it is safe to assume that this is the case. The cure is to reduce the input to the microphone by holding it farther from the mouth or by shunting a resistance across the secondary of the microphone transformer. The latter method will improve the characteristics of the transformer and if a variable resistor of about 100,000 ohms maximum is used, it will provide an excellent method of controlling the output of the modulation system.

#### THE ADJUSTMENT OF THE SET

Start the oscillator going with no plate voltage on the amplifier but the amplifier tube filament lighted. Vary the tank condenser of the amplifier and it will be found that the plate milliammeter of the oscillator will jump at a certain setting of the amplifier condenser. More than likely the oscillator plate current will increase at this point. Adjust the neutralizing condenser until the oscillator plate current returns to normal. On shifting the amplifier condenser now, it will be found it has hardly any effect on the oscillator plate current. Without shielding it will be very difficult to adjust to a point where no effect is noted on the oscillator when the amplifier tank condenser is varied. The point of least effect, however, is the point of most complete neutralization.

Now place a low voltage on the plate of the amplifier. If a grid leak is used adjust the amplifier tank condenser until a sharp dip in plate current is noted. At this point the amplifier stage is in resonance with the oscillator. The antenna is now tuned to

the amplifier in the usual way. Now increase the plate voltage on the amplifier stage to normal, making small adjustments of the tank condenser to give highest antenna current for lowest plate current. Vary the antenna coil coupling to the point where the antenna current is greatest with the lowest plate current.

Now that we have the c.w. part of the set going, the next thing is to impress modulation on the carrier. With plate volt-

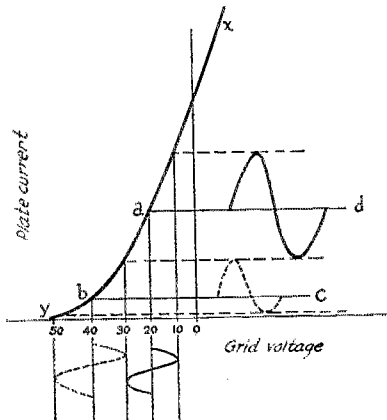

FIGURE 3. THE ABOVE CURVE SHOWS THE EFFECT UPON THE OUTPUT WAVE SHAPE OF THE BIAS AT WHICH THE TUBE IS OPERATED

When being operated with the grid 40 volts negative, the positive alternation causes a much greater change in plate current than does the negative alternation. This is not the case when about 20 volts is applied to the grid. For undistorted output, it is essential that the tube be worked on the straight portion of the curve.

age on the modulator, the bias is adjusted until the tube runs fairly cool. With the speech amplifier turned on, whistle into the microphone. The modulator plate current will, more than likely, jump up to some higher value and remain so until the whistle is stopped. Decrease the "C" battery voltage on the modulator until its plate milliammeter neither jumps up nor down when whistling into the microphone.

It will be found that when using almost any bias on the modulator without regard to speech quality, the antenna current will increase when modulating. The increase in antenna current may be more with an improper bias than when the modulator is properly adjusted so don't work for greatest increase in antenna current, and place that above all other things. The antenna current is not a true indication of the goodness or amount of modulation at all, unless all other adjustments of the set are properly made.

When the modulating system is being adjusted it will be well to check the output

of the speech amplifier by means of a head-set placed in the plate circuit of the 201-A amplifier tube. A low reading milliammeter in the plate circuit may also be used, adjusting the "C" battery of the speech amplifier until no kick is had on this meter.

With the modulator properly biased its plate current will jerk back and forth somewhat when talking, and no amount of whistling, etcetera, will make the modulator plate current jump up to a higher value or down to a lower one and remain so, as long as modulation is impressed. The

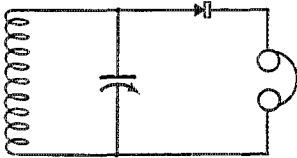

FIGURE 4. THE TEST SET CONSISTS OF A FREQUENCY METER WITH A CRYSTAL DETECTOR AND PAIR OF PHONES SHUNTED ACROSS IT

If a regular frequency meter is not available, any coil and condenser which will tune to the transmitted frequency will do.

amplifier plate current will jump a little also but not as much as the modulator.

With these adjustments made, make the following test to determine if an amplification of all voice frequencies is being effected by the set: Note the antenna current reading with no modulation. Now hum a low note into the microphone, and note the antenna current increase. Suppose the increase is .1 ampere. Now hum a medium pitched note of the same volume as the low, and the antenna current should increase .1 ampere as before. In the same way try a high note and the results should be the same. Last of all, try whistling and the antenna current should not increase so very much more than for the lowest note.<sup>2</sup>

If the set does give a level increase throughout the voice scale it's a very good indication that everything is working satisfactorily.

Now just one other test and we will be through.

Hook up a crystal detector circuit as shown in Fig. 4. The circuit LC may be your regular frequency meter. The phones and crystal are connected as shown. When

2. The value of this test is somewhat doubtful unless one can be sure that the intensity of the notes hummed are about the same. It is quite easy to put more energy into some notes than into others and so it would be advisable to also run the next test before condemning the set if it does not pass this test. I have since learned that a violin maintaining a constant pressure and speed of the bow across the strings gives better and more quantitative results.

the frequency meter circuit is tuned to the frequency of the transmitter, the modulation will be heard just as it is being put out on the air. If the motor-generator set, or what have you, is making a bad hum it shows up in the check receiver. If over-modulation is taking place it very quickly shows up, and correction can easily be made without taking some distant station's word for it.

After I had my set going per all directions except the check set I received reports of very poor modulation, yet when I biased the modulator tube so it would kick up, good reports were received. On connecting up the check set it was found that room echo did not seem to bother when the modulator was biased high, but the voice sounded cracked and dry. When proper adjustments were made every word spoken was followed by a very bad echo giving a hollow, distorted effect. An ordinary telephone microphone was being used. To overcome the echo difficulty a disc of cardboard was cut and glued into the front part of the mouth piece of the microphone. In this disc were punched about 15 holes the size of the lead in a pencil. When the metal cover that fits over the back of the microphone was fitted tightly in place, the echo disappeared. To listen to the output now one wouldn't know that a studio was not being used.

The reason the echo bothered when the proper adjustment was made was because the set was sensitive to practically all frequencies under this condition, while under improper conditions it discriminated against certain bands of frequencies.

As for results with this set, they were even better than had ever been hoped for. With an amplifier input never exceeding 100 watts, reports have been received from all parts of the United States and Canada. After adjustments were properly made, the set meeting the tests described, all reports from the many communications held throughout the central and eastern part of the United States and Canada gave the modulation as being very good or perfect, many stating the signal sounded like that of a broadcast station.

With a number of stations worked the operator was asked to set his receiver into oscillation and tune to zero beat with the carrier. In every case when this was tried the report was given that the modulation was practically as clear as when the receiver was not oscillating. This indicates that the amount of wobble is insignificant.

The problem of plate supply was not bothersome and when using a motor-generator with a 62-segment commutator, no hum or ripple was noted although the only filter used was a 2- $\mu$ f. condenser across the brushes.

## Push-Pull Transmitters

By James J. Lamb\*

**T**HE realization of one hundred per cent performance on the part of the 1929 short-wave transmitter is nothing more than the practical application of that epigram of the artist Michelangelo, "Trifles make perfection but perfection is no trifle." The difference between a truly effective signal and a very mediocre or even poor one may be due to some seemingly unimportant triviality but the proper

ments as a result of the changes in temperature which must inevitably accompany operation. Against this problem must be matched the utmost care in design and construction.

The inter-element capacitances are not great in terms of units of capacity nor are the changes in capacitance large in the absolute sense. Their effectiveness in causing a variation in frequency is considerable only

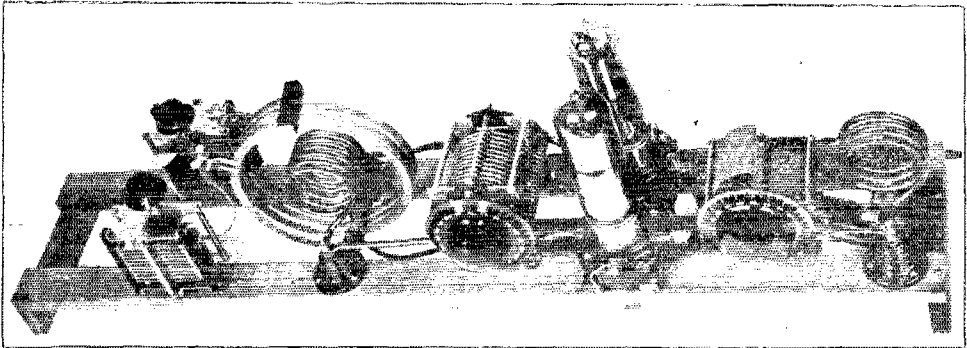

THE 100-WATT PUSH-PULL, TUNED-GRID, TUNED-PLATE TRANSMITTER

The frame consists of treated strips of "printer's furniture". The two vertically mounted variable condensers at the left are for antenna tuning. The plate tank condenser is to the left of the tubes and the grid tank condenser to the right of the tubes. Grid blocking, plate blocking and filament by-pass condensers are mounted beneath the frame together with the grid leak.

attention to this results in a perfect signal. A perfect signal is no trifle.

The goal to be constantly striven for is frequency stability. Anything which contributes to this stability is good. Anything which detracts from it is bad. Infinite pains taken to eliminate any feature inimical to frequency stability are justifiable. Rigid mechanical construction and low loss equipment are fundamental in striving for frequency stability. Plate and filament power supplies should have the best voltage regulation characteristics possible. But even after these considerations have been satisfied there remain inherent properties of the vacuum tube itself which can defeat all the gains realized in the attempt to attain constant frequency. One of these is the variation of inter-electrode capacitance due to mechanical vibration of the tube at audio frequencies and against which ordinary precautions in preventing vibration from reaching the tubes are effective. The second is the variation in inter-electrode capacitance due to contraction and expansion of the metal ele-

in the proportion which exists between the change in their capacitance and the total parallel capacitance of which they are a part. If the total parallel capacitance is made large, the change in the inter-electrode capacitance is made correspondingly less effective. Thus the High-C type of circuit goes a long way towards accomplishing to the limit of its application. This limit is reached when the losses attendant on the high tank circuit currents resulting become so large as to prevent the sustaining of an oscillating condition. Accordingly, further application of the principle cannot be additional increase in the tank circuit capacitance but must be a decrease in the internal tube capacitances which are causing the frequency variation. Obviously these are locked up inside the envelope of the tube and cannot be directly operated upon. Therefore it is necessary to resort to a process of going around through the back door in order to get to the front.

1. Overhauling the Transmitter for 1928, QST, August 1928. Adapting Medium and High-Powered Self-Excited Transmitters for 1929 Service, QST, September, 1928.

\*W1CEI-W1SZ. A.R.R.L. Technical Information Service and Experimenters' Section.

Figure 1 is a conventional transmitter circuit of the High-C type, which in this case happens to be of the Armstrong or tuned-grid, tuned-plate variety. Immediately below it is the equivalent circuit illustrating the relation of the various inter-electrode capacitances to the rest of the circuit.  $C_{gf}$  and  $C_{pf}$  are in parallel with the grid and plate tank circuits respectively and

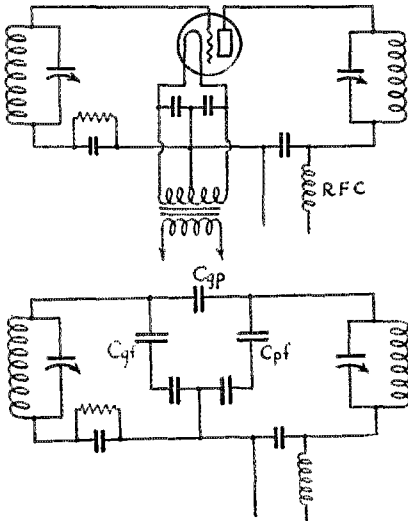

FIGURE 1. CONVENTIONAL HIGH-C TUNED-GRID, TUNED-PLATE CIRCUIT

The specifications are the same as given in Figure 2. The tube is a 203-A.

it is obvious that any change in  $C_{gf}$  or  $C_{pf}$  will cause a corresponding change in the constants of their associated tank circuits and a change in frequency. If two tubes are used in parallel this change in inter-electrode capacity will be doubled in effect or in actual practice more than doubled. This latter statement is made advisedly. Since the current through a group of capacitances in parallel will be divided between them in direct proportion to their value, the greater  $C_{gf}$  and  $C_{pf}$  are in proportion to the total parallel capacitance, the greater the proportion of the tank circuit radio frequency current which will take its path through the tube. When two tubes are connected in parallel, the values of  $C_{gf}$  and  $C_{pf}$  are doubled.

Taking as a specific example a typical High-C transmitter such as that shown in the accompanying photograph, the total plate tank capacitance will be of the order of 525  $\mu\text{fd}$  for tuning to the 7,000 kc. band. This includes the plate-filament capacitance of the tube which may be assumed as 15  $\mu\text{fd}$ . Considering the total tank current as 10 amperes with one tube, .3 amperes of this cur-

rent will flow through the plate-filament tube capacity. With two tubes in parallel and the power in the plate circuit practically doubled, the tank current becomes 40 per cent greater, or 14 amperes. The plate-filament tube capacity has also been doubled, and in order to tune the circuit to the same frequency the capacity of the tuning condenser must be decreased by an amount equal to the plate-filament capacity of the second tube. The amount of the total current which now passes through the combined plate-filament tube capacitances becomes .8 ampere, or .4 ampere through each tube. The increase in current through each tube is therefore 33 1/3 per cent.

The tube capacitances become a larger proportion of the total tank capacitance and their ability to influence frequency changes correspondingly increases. Moreover, the increased current through each of the tubes gives rise to additional heating of the elements and further aggravates the altogether undesirable frequency shifting. For these reasons the operation of tubes in parallel in high frequency transmitters does not look so good. Some means of reducing the effective tube capacitances as a proportion of the total tank capacitance appears to be justifiable, and in the push-pull type of transmitter a solution is found. The advantage is seemingly trifling, but the approach towards realization of constant frequency is appreciable.

Consider the circuit shown in Figure 2 and its accompanying equivalent capacity diagram. This is the push-pull version of the tuned-grid, tuned-plate circuit of Figure 1. The striking feature at once noticeable is that the capacitances  $C_{gf}$  are in series with each other with respect to their associated tank circuit condenser, as are also the two capacitances  $C_{pf}$  in series with each other with respect to the plate tank tuning condenser. The effective inter-electrode capacitances are therefore reduced to one half what they are in the one tube circuit of Figure 1 or to one fourth of what they are with two tubes in parallel. The proportion of the total tank circuit currents through the tube capacitances has been reduced in the same or even greater proportion, as has also the capability of variation in inter-electrode capacitance for changing frequency been cut down. A UV-203-A tube has an effective input capacity of 24.1  $\mu\text{fd}$ ,<sup>2</sup> and a plate-filament capacity of 15.5  $\mu\text{fd}$ . The tank current in the plate circuit of the transmitter is much greater than that in the grid circuit tank, and is therefore to be considered. If the plate tank tuning condenser has a capacity of 500  $\mu\text{fd}$ . in the High-C circuit of Figure 1 (a quite usual capacity),

2. The input capacity is not the same as the measured grid-filament capacity of the tube itself. (See page 212, *Thermionic Vacuum Tube*, Van Der Bijl).



the ratio of Cpf to the total plate tank capacitance is approximately 1 to 35. With two tubes in parallel it is 1 to 17 or 18 while in the push-pull arrangement it becomes 1 to 70. The corresponding grid circuit ratios, with the same value of total tank capacitance, are 1 to 20 with the one tube arrangement, 1 to 10 with two tubes in parallel and 1 to 40 with the push-pull circuit. Going back to the plate circuit where the heavy tank currents are found, with three per cent of the total tank current flowing through the plate-filament capacitance when the one tube arrangement is used and approximately the same per-

each tube has been reduced one half, whatever heating effect there may be from this current is reduced to one fourth. Each of these gains is but a trifle but each is a milestone on the way to the perfection being sought.

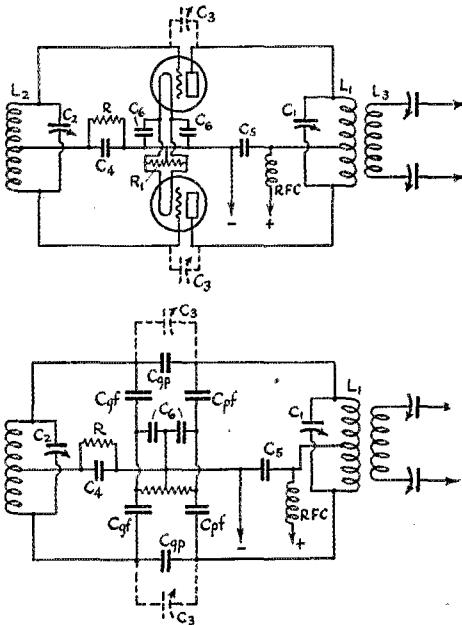

FIGURE 2. PUSH-PULL, TUNED GRID, TUNED PLATE CIRCUIT.

- C1. 350- $\mu$ fd. double spaced, transmitting type, National.
- C2. 1,000- $\mu$ fd. receiving condenser, Cardwell.
- C3. 25- $\mu$ fd. variable transmitting condenser.
- C4, C5. 300- $\mu$ fd. Paradon transmitting blocking condensers.
- C6. 2,000- $\mu$ fd. Sangamo receiving condensers.
- L1. Plate coil of  $\frac{1}{4}$ -inch copper tubing, 3 inches in diameter. 6 turns for 7,000 kc. and 2 turns for 14,000 kc.
- L2. Grid coil of  $\frac{1}{4}$ -inch copper tubing, 3 inches in diameter. 4 turns for 7,000 kc. and 2 turns for 14,000 kc.
- LS. 4 turns of edgewise wound copper strip, 7 inches in diameter, directly around L1.
- R. 10,000-ohm grid leak.
- R1. Filament center-tap resistor.

centage through each tube with two tubes in parallel, there will be but 1½ per cent of the total tank current through each tube in the push-pull circuit. Since the proportion of tank circuit radio frequency through

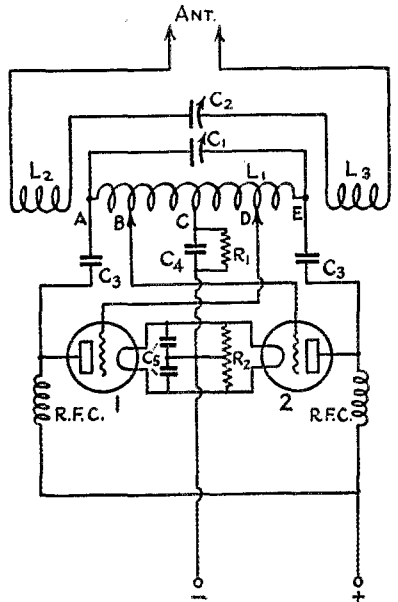

FIGURE 3. PUSH-PULL HARTLEY CIRCUIT.

- L1. 5 or 6 turns of  $\frac{3}{8}$ -inch copper tubing 4 inches in diameter for 7,000 kc. operation.
- L2, L3. Split antenna coil. Each coil consists of 5 turns of  $\frac{1}{4}$ -inch copper tubing 3 inches in diameter.
- C1. 500- $\mu$ fd. 3,000-volt transmitting condenser.
- C2. 250- $\mu$ fd. double spaced, Cardwell receiving condenser.
- C3, C4. 500- $\mu$ fd., 5,000-volt Sangamo fixed condenser.
- C5. 2,000- $\mu$ fd. Sangamo receiving condensers.
- R1. 20,000-ohm grid leak.
- R2. 200-ohm center tapped resistor.
- Tubes are UX-352.

The push-pull type of transmitter has another commendable feature which cannot be overlooked. Under the old frequency assignments the amateur has not had much cause to worry over whether or not his transmitter happened to be radiating harmonics of its main frequency. All the bands have had their upper and lower limits in harmonic relation so that the strong even harmonics which might happen to be present have fallen within the higher frequency bands, and have given no cause for complaint on the part of interests other than amateur. Under the new assignments, however, this situation no longer exists in the same degree. The particular bands which may have harmonics outside amateur territory are 1750 kc., 3500 kc. and 7000 kc. Therefore it may be con-

sidered expedient to eliminate the possibility of radiating a harmonic in somebody else's territory. The High-C circuit is inherently a very poor generator of harmonics, and the push-pull circuit goes even further and the second harmonic, which ordinarily is the strongest, is actually cancelled out.<sup>4</sup>

In construction there is nothing unusual about the push-pull transmitter of the photograph and diagram Figure 2. In fact, the number of parts, with the addition of the second tube and socket, is the same as

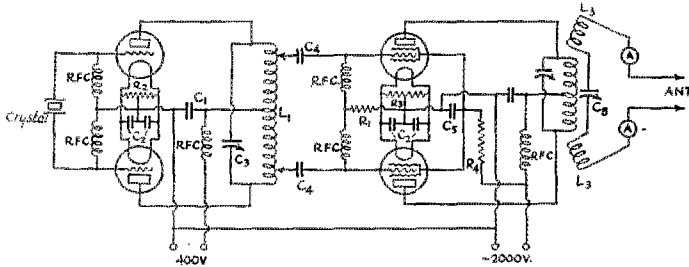

FIGURE 1. PUSH-PULL CRYSTAL CONTROLLED OSCILLATOR-AMPLIFIER TRANSMITTER.

Specifications are as usual for the tube used. Two UX-210 tubes are used in the oscillator and two UX-880 tubes in the amplifier. R2 is a variable grid leak with a maximum resistance of about 20,000 ohms. A Bradley leak might be used. R4 has a resistance of 100,000 ohms and provides the proper screen-grid voltage.

for the transmitter shown in Figure 1. The adjustment is exactly the same as for any other tuned-grid, tuned-plate transmitter and is quite clearly described on page 29 of QST for September, 1928. The push-pull transmitter shown is surprisingly efficient and effective in operation. In laboratory tests on 7,000 kc., the input has been run as high as 600 watts with a plate voltage of 1500 without visible indication of excessive plate heating on the part of the two UV-203-A tubes used. Such input is obviously not recommended for operation, but gives an indication of the efficiency which may be expected at normal input. The tendency for the frequency to creep is hardly detectable, and on the air the signals are invariably reported d.c. and crystal control. The plate supply consists of a motor-generator with a 2- $\mu$ f. condenser across the brushes as a filter.

The tuned-grid, tuned-plate circuit is not entirely satisfactory in its usual form with every type of transmitting tube. Since with this circuit the grid-plate capacitance must be depended upon for coupling between the plate and grid circuits for grid excitation, there must be grid-plate capacitance of sufficiently low reactance to do the job. Tubes such as the UX-852 and DeFor-

est "H" do not in themselves possess this capacitance in a sufficient degree, although in some cases it is supplied by the wiring and if the tuned-grid, tuned-plate circuit is to be properly used with these tubes, coupling between the grid and plate circuits external to the tubes must be provided. One method is shown in the dotted lines of Figure 2. The coupling condensers may be high voltage, variable condensers having a maximum capacity of 25- $\mu$ fd. The value of capacity is not extremely critical except in that both should be the same so that each tube will receive equal excitation. Tubes which have sufficient grid-plate capacitance are the UX-210, and UV-203-A and UV-204-A or tubes of similar type.

In addition to this method of securing the proper coupling between the grid and plate circuits there are many others. These may be generally classified as capacitive and inductive. The tuned-grid, tuned-plate, Colpitts and allied types of circuit provide the capacitive coupling, while the Hartley, Meissner and modifications thereof provide inductive or combined capacitive and inductive coupling. The push-pull families of circuits are subject to a wider variety of circuit arrangement than the straight fundamental parent circuits, and it would be a stupendous task beyond the scope of this article to attempt to cover them all.

As an example of the method of inductive coupling the Hartley is illustrated in the circuit diagram of Figure 3. This particular version happens to be shunt feed with the grid blocking condenser and grid leak in the grid return circuit. This arrangement utilizes the minimum number of pieces of apparatus possible with a push-pull Hartley. The point C is the exact electrical center of the inductance. Grid excitation of tube 1 is determined by the turns CD while that of tube 2 is determined by the turns CB. The number of turns in CD and CB should always be kept exactly equal so that the tubes are given equal excitation. To increase excitation, move the grid clips away from the center C, and to decrease excitation move the clips towards the center C. The setting of the grid clips is not highly critical, each being about one turn from the center with the 5-turn 7000 kc. inductance. The adjustment otherwise is the same as for the conventional Hartley.

(Continued on Page 82)

3. Page 22, QST, September, 1928.

4. Page 261, Thermionic Vacuum Tube, Van Der Bijl.

## Radio On the Byrd Expedition

COMMANDER BYRD, with four or five ships, a covey of planes, a personnel of seventy and enough supplies of all human needs for a small city, is at the moment somewhere between here and the South Pole, on his way to establish what may be an additional hurdle for aspirants to W.A.C. Club certificates. Since the expedition thus concerns us, and since their communication with the rest of the world during the next two or three years will be almost entirely through amateur radio, a few notes are in order on the very considerable radio equipment and personnel which form an important part of the expedition.

In the radio engineering and operating staff we find men already noted for the work they have done. As Chief, goes Malcolm P. Hanson, of the Naval Research

ships which are to remain in the Antarctic, the *Eleanor Boling* (WFAT) and the *City of New York* (WFBT) (the other ships merely carry supplies to the ice-base and will return immediately) carry two transmitters each, one high frequency and one intermediate frequency. The high-frequency sets were designed and built by the

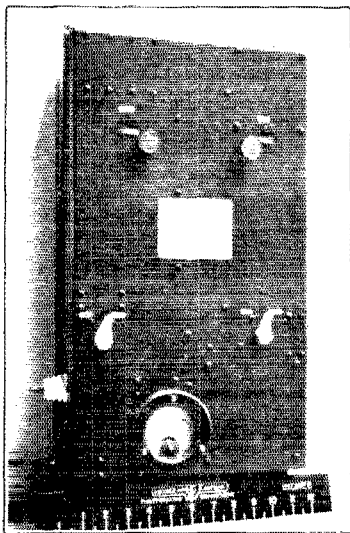
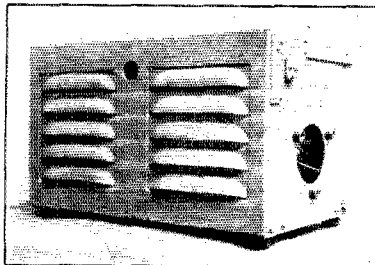

FRONT VIEW OF THE AIRPLANE TRANSMITTER

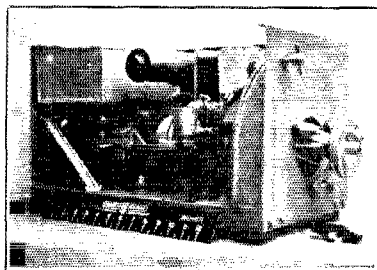

EMERGENCY POWER PLANT FOR THE AIRPLANE TRANSMITTERS

A single-cylinder 2-cycle gasoline engine direct coupled to the generator. For use in case of forced landing on the ice. The unit is supplied with legs so that it can be set over an alcohol stove to keep the lubricating oil from congealing.

Laboratory. With him are Howard F. Mason, formerly of the *QST* staff and more recently with the Wilkins-Detroit Arctic Expeditions; Lloyd Berkner of the Bustan; Lloyd Grenlie who was with the Byrd Arctic Expedition; and Carl Peterson, Norwegian commercial operator since 1917 with some flying experience. These are the men who will be behind the keys of the various ship, shore, airplane and portable transmitters of the expedition.

Both high and intermediate frequency radio equipment is to be used. The two

radio staff of the expedition. The set on the *Eleanor Boling* (WFAT) employs two  $\frac{1}{4}$  kw. tubes in a conventional T.P.-T.G. circuit. The *City of New York* (WFBT) set uses two  $\frac{3}{4}$  kw. tubes in a modification of the so-called "Simpson" circuit for which A. M. Trogner, R. B. Meyer, L. C. Young, and M. P. Hanson are apparently jointly responsible.

The high frequency airplane transmitters were built by Heintz and Kaufman and are so designed that a switch on the panel throws them from a predetermined high frequency to a predetermined intermediate frequency. The power supply for all planes is 250- to 300-cycle a.c. obtained from generators driven by the engines. Emergency wind-driven generators are provided.

The airplane receivers are super-regenerative. Hanson designed them and supervised their construction, which was done by the National Electric Supply Company. For reception, the planes will use as antenna a doublet running from wing-tips to rear

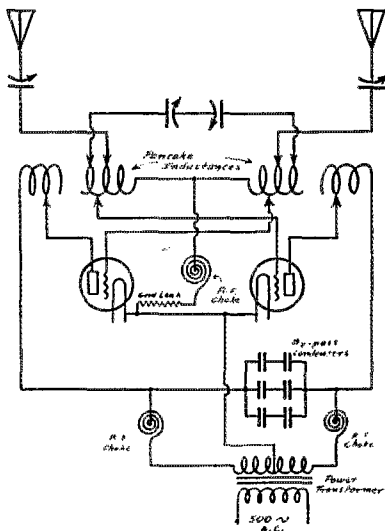

THE PUSH-PULL SERIES FEED CIRCUIT OF THE WFBT TRANSMITTER

The pencake inductances are arranged after the fashion of the once popular four-coil Meissner Circuit. Two  $\frac{3}{4}$ -kw. tubes are used.

of fuselage and then forward to the cabin. For transmission they will probably use single trailing wires, working against the frame of the ship as counterpoise, although, for intermediate frequencies, they will experiment with a doublet up to 300 feet long of wires trailing from wing-tips. The planes on the expedition are as follows: A Ford tri-motor ship, the *Floyd Bennett*, WFB; a Fokker single motor ship, the *Virginian*, WFF; a Fairchild, the *Stars and Stripes*, WFC; a General Aircraft Corporation single motor monoplane, probably using WFD or WFE.

Small battery-operated portable transmitters, made by the Burgess Battery Company, will be carried by advance parties and will use the calls WFD and WFE.

A master station, WFA, a duplicate of WFAT, will be built at the main base of the expedition which is to be established on the ice barrier, probably near the Bay of Whales.

KFK is a general call for all units of the expedition.

All stations of the expedition are licensed to use frequencies as follows: On intermedi-

ate frequencies, a calling frequency of 500 kc. and working frequencies of 375 and 425.5 kc., on high frequency, calling frequencies of 5,600, 11,200 and 16,800 kc., and working frequencies of 3290, 4405, 5650, 6580, 8810, 11,300, 13,187, 16,717 and 21,805 kc. It is probable that the 3290, 4405, 6580 and 8810 kc. frequencies only, will be used for all communication.

QST will report, as regularly as possible, the radio communication work of the expedition, and will probably be able to publish information on frequencies being used by the various units. In the meantime, keep a watch for the calls mentioned above.

With the exception of some made temporarily for the trip down, no schedules have been decided upon. The stations who will handle the traffic of the expedition will be those who not only put the best signals into the Antarctic but also prove them-

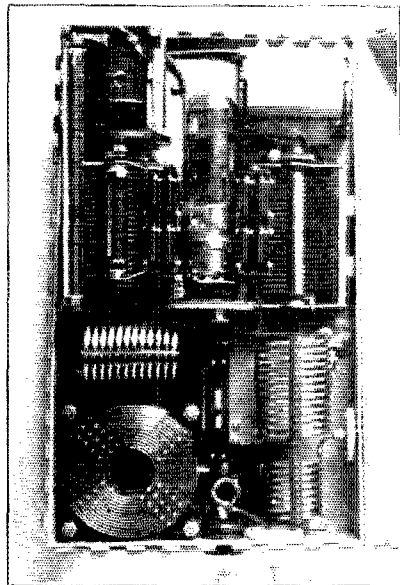

BACK VIEW OF AIRPLANE TRANSMITTER WITH COVER OPEN

Intermediate and high frequency inductances are in the lower part with tube, tuning condensers, etc., at the top.

selves most dependable and business-like in the handling of the expedition's important communications. The amateurs who do their part toward the success of Commander Byrd's undertaking will share credit with the members of the Expedition themselves and will add another fine accomplishment to the scroll of amateur achievements.

## The Army-Amateur Transmitter W1WF, First Corps Area

By Lloyd T. Goldsmith\* and A. Earl Cullum, Jr.\*\*

**A** NEW transmitter has recently been placed in operation as the net control station of the Army Amateur Radio Net, First Corps Area. This transmitter was built for the signal Corps R.O.T.C. Unit at the Massachusetts Institute of Technology. This set was built at the Massachusetts Institute of Technology under specifications prepared by the office of the Chief Signal Officer of the Army, only modified to such an extent as was necessary to include the very latest developments and refinements of the radio art. It comprises a W.E. 211-D fifty watt tube as a crystal oscillator, another as a frequency doubler, and a UV-204-A, 250-watt tube, as an amplifier.

Using a crystal having a fundamental frequency of 1,910 kilocycles (157 meters) there results a frequency of 3820 kilocycles (78.5 meters). This channel is used for regular army-amateur communication. A second crystal with a fundamental of 2040 kilocycles (147 meters) may be plugged into the pair of General Radio jacks on the front panel allowing a frequency of 4080 kilocycles (73.5 meters) to be used for purely army business in the army wave band. Ruggedness and reliability together with flexibility and accessibility of parts have been kept in mind throughout the construction of the set.

The transmitter is built in a 23½ by 20¼ by 20-inch frame of 1" white wood which has been dried and treated. The three front panels are each 7" by 21", the long edges of which have been beveled.

The crystal oscillator on the lower shelf uses an underloaded 50-watt tube rather than a tube such as a UX-210 because of the fact that the lower power tube is not available for army use. The oscillator plate coil is a type "L" REL inductance which is tuned by a 500- $\mu$ fd. National receiving condenser shunted by a 250- $\mu$ fd. Sangamo fixed receiving condenser in order that this tank circuit will tune to the crystal frequency. The grid of the tube is biased 45 volts negative.

The radio frequency choke coils in all the plate and grid leads are thin honeycomb-wound coils of 500 turns of No. 36 enameled single cotton covered wire. The outside diameter is slightly over 3", the inside

diameter is 1½", and the thickness is ¼". They are mounted between two 3" by ½" bakelite strips which are secured to the socket terminals by small angles. The fundamental frequency of the chokes is

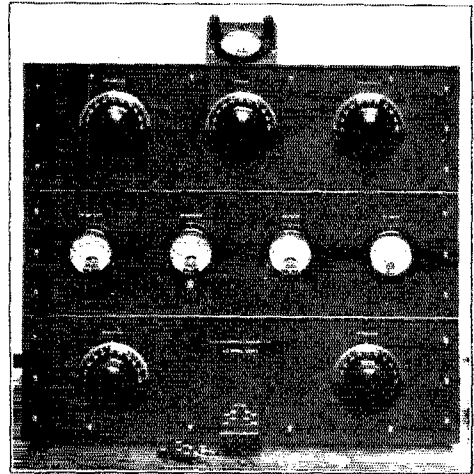

THE TRANSMITTER PANEL

One of the crystals is plugged in to the set while the other lies on the table in front of it. The meter mounted in the sloping manner on top is the antenna meter.

well below that for which they are used, so there is no danger of their being tuned to a working frequency and absorbing power.

The grid and plate fixed condensers are 2000- $\mu$ fd. Dubiliers and the filament bypass condensers are 2000- $\mu$ fd. Sangamos.

The REL coil in the plate circuit of the frequency doubler is mounted at right angles to the oscillator coil and is tuned with a National transmitting condenser of 230- $\mu$ fd. capacity. The grid and plate condensers are similar to those used in the crystal stage. The grid of the tube is biased 220 volts negative.

The amplifier stage is mounted on the upper shelf with the 250-watt tube at the rear. The tube socket is mounted on General Radio stand-off insulators to raise the tube from the shelf. The plate coil is tuned with a National transmitting condenser of 230- $\mu$ fd. capacity. The grid is biased 90 volts negative.

\*Round Hills Short Wave Radio Research.

\*\*Technical Staff of WFAA (Dallas, Texas) President of M.I.T. Radio Society.

Because the 250-watt tube is used as an amplifier and is working at the same frequency as the preceding stage, it is necessary to neutralize the tube to prevent it from oscillating. This is accomplished by connecting a 125- $\mu$ fd. condenser from the grid terminal of the amplifier to the lower

which surround the high voltage posts have been provided to prevent an accidental contact with the high voltage. All the terminals are plainly marked on a celluloid strip directly above them.

The tube filaments are supplied with a.c. from a 175-watt Thordarson filament-heating transformer. The filament voltage of the 204-A is 11 volts while 0.3 ohm resistances in each leg of the filaments of the 211-D's reduce the voltage to 9 volts as required by them.

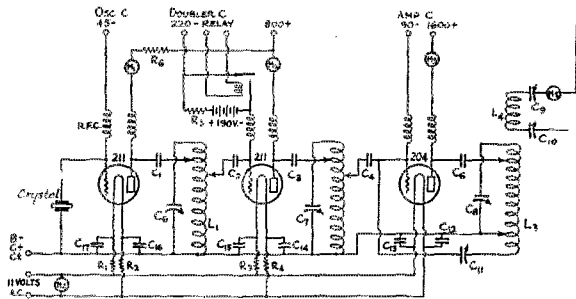

FIGURE 1. CIRCUIT DIAGRAM

*C1, C2, C3, C4 and C5—2000- $\mu$ fd., 5000-volt fixed condenser.  
C6—500- $\mu$ fd. National variable shunted by 250- $\mu$ fd., fixed condenser*

*C7, C8—250- $\mu$ fd. National transmitting variable condensers.  
C9, C10—450- $\mu$ fd. National transmitting variable condensers.  
C11—125- $\mu$ fd., 500 volt variable condenser.*

*C12, C13, C14, C15, C16, C17—2000- $\mu$ fd. fixed condensers.*

*R1, R2, R3, R4—0.3 ohms.*

*R5, 50,000-ohm 6 watt Tobe resistor.*

*R6—five resistors totaling 15,500 ohms and capable of passing*

*100 mls.*

*RFC—500 turns, 2 1/4 inch mean diameter.*

*M1—Weston, 100 milliamperes.*

*M2—Weston, 300 milliamperes.*

*M3—Weston, 500 milliamperes.*

*M4—Weston, 15 volts, a. c.*

*M5—Weston, 5 amperes, radio frequency.*

*L1, L2, L3, L4—type "L" REL inductances.*

end of its plate coil. This condenser can be seen in the photograph fastened to the underside of the upper shelf. Once the stage has been neutralized, the condenser need not be touched unless another tube is used. By proper placement of parts, no need was found for shielding the amplifier stage. Although the different parts have been separated far enough to prevent crowding, all the tank circuit leads have been kept short and direct.

The antenna is loosely coupled to the plate coil of the amplifier by sliding the antenna coil along glass rods which serve as supports for both of the coils. The antenna condensers are each 450- $\mu$ fd. capacity.

The antenna used with this transmitter is a vertical half-wave antenna with a fundamental of 4000 kilocycles, which is voltage fed with 1/4-wave feeders. (For complete information on this type of antenna system see the article in March QST by J. K. Clapp and H. A. Chinn.)

A binding post strip is mounted across the back of the frame. Bakelite guard strips

High voltage for the transmitter is supplied at 800 and 1600 volts d.c. from a 2-kw. motor-generator. The amplifier is supplied with 1600 volts, the frequency doubler with 800 volts, while the voltage on the plate of the oscillator is reduced to 350 volts by five fixed resistors totalling 15,500 ohms. The resistors are mounted on brass rods between bakelite strips and in the rear view of the transmitter can be seen mounted on the underside of the upper shelf near the front panel.

Keying is accomplished by blocking the grid of the frequency-doubler by the addition of 190 volts more than the normal 220. The keying is done with a relay which shorts this additional voltage through a 50,000-ohm Tobe resistor. (See Fig. 1.) The necessary bias for all the tubes is supplied from small dry B batteries.

On the front lower panel are the oscillator tuning dial, the crystal mounting jacks, and the frequency doubler or first amplifier tuning dial. On the center panel are the plate milliammeters of the three tubes as well as a filament voltmeter. The second amplifier tuning dial and the dials of the two antenna feeder condensers are on the upper panel. In order to keep the antenna leads short the antenna meter is mounted on a small panel above the front panel and inclined to it. Binding posts are provided for the feeder wires.

The high voltage is brought to the plate milliammeters by high tension cable. The wiring in the radio-frequency circuits is done with No. 12 soft drawn copper wire and 3/8" copper braid. The filament wiring is done with stranded rubber-covered wire and cabled wherever possible. Small bakelite bushings are used where leads pass through the shelves.

A sketch of the crystal holder is given in Fig. 2. Its essential points are its small size, the small separation between the crystal and the upper plate and the fact that one of the plates is smaller than the size of the crystal. The latter two points help

materially in making a stubborn crystal oscillate. The best material for the plates is nickel, as brass gets tarnished, but in the absence of nickel, nickel-plated brass does very well.

The crystal holder is of the type that allows a small air gap between the crystal and the upper electrode. A piece of bakelite  $1\frac{3}{4}$  inches square acts as the main support member of the unit and carries the two plugs through which contact is made to the plate. The upper electrode is of  $\frac{1}{8}$  inch thickness and is slightly smaller than the crystal itself. It is fastened to the piece of bakelite by means of two machine screws. The lower plate is of  $1/16$ -inch brass and is also  $1\frac{3}{4}$  inches square. A second piece of bakelite (also  $1\frac{3}{4}$  inches square) is used as a spacer to keep the two plates the proper distance apart. A hole that is slightly larger than the crystal is cut in the center. This piece of bakelite is filed down so that its thickness is equivalent to the thickness of the upper

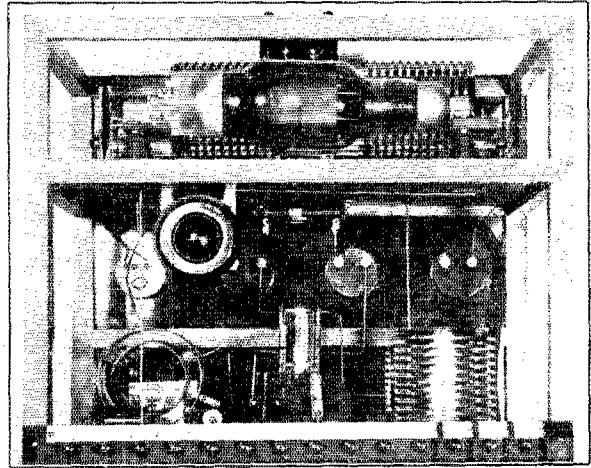

THE REAR VIEW SHOWS THE MOUNTING OF THE 204-A ON SMALL STAND-OFF INSULATORS.

Fastened to the under surface of the shelf holding the 204-A is the neutralizing condenser and the bank of resistors employed to reduce the voltage applied to the plate of the crystal oscillator. The r.f. choke mentioned in the article may be seen in front of the 211-D in the center of the lower sections.

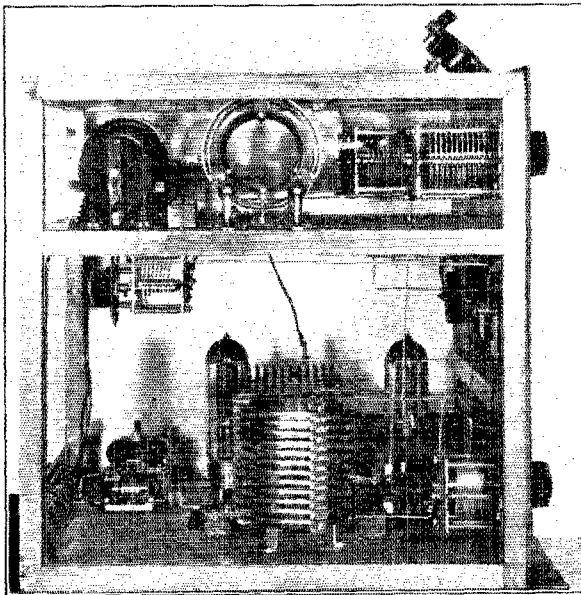

A SIDE VIEW THAT MORE CLEARLY SHOWS THE ARRANGEMENT OF THE EQUIPMENT

The keying relay and the resistor which shunts the extra bias when the key is closed may be seen at the lower left. The bakelite partitions which protect against accidental contact to the high voltage binding posts may also be seen with greater clarity.

plate, plus the crystal, plus .004 inches. On stacking, we have the  $\frac{1}{4}$ -inch bakelite plate carrying terminals and upper electrode, the spacer of bakelite and the lower  $1/16$ -inch brass plate. The crystal is located between the upper and lower plates in the hollowed out portion of the spacer. There is an air gap of .004 inches between the crystal and upper plate. The brass plates are all nickel plated and the assembly is held together by means of four 6-32 nickel-plated machine screws, one in each corner.

Contact is made between the General Radio plugs and the crystal plates by springs that are taken from automobile tire valve insides that are obtainable at any garage or auto supply store. As may be seen from the figure, one of the holes which is threaded to take the plug is drilled through the screw holding the upper plate passes. In other words, the hole is drilled all the way through and only part of it tapped to take the GR plug. The spring is fitted in this hole and makes contact between the screw holding the upper plate and the end of the plug.

The other spring makes contact between the other plug and the lower plate. A hole is drilled in the underside of the bakelite

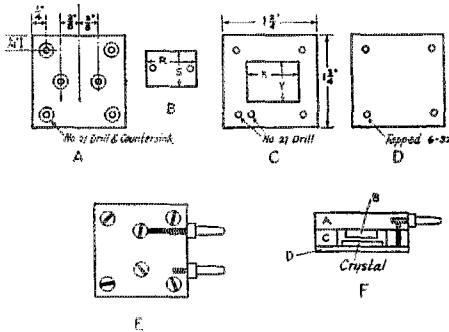

FIGURE 2  
CONSTRUCTION OF HOLDER

A—Top piece of bakelite  $\frac{1}{4}$  inch thick. The two holes in the center pass the screws that hold the upper plate.

B—The upper plate of brass. It is slightly smaller than the crystal.

C—The spacing plate of bakelite. The crystal fits loosely in the hollowed out portion of it. It is filed down so that its thickness is equivalent to the thickness of the upper plate, crystal and an air gap of .004 inches. The extra hole in the lower left hand corner is to accommodate the spring that makes contact between the shank of the plug and the lower plate.

D—The lower plate of  $\frac{1}{16}$  inch brass. The holes in the corners are threaded to take the screws that are used to hold the assembly together, which in this case are 6-32 flat-headed nickel-plated machine screws.

E—A view of the top of the mounting. This shows the manner in which the hole that is tapped to take the plug is extended into the one carrying the screw holding the upper plate. A small spring is inserted in this hole and makes contact between the plate and plug.

F—This shows a side view of the mounting and the manner of making contact between the other plug and the lower plate. This, also, is by means of a spring in a hole that exposes the shank of the plug and the lower plate to each other. The crystal is slightly smaller than the space hollowed out of the spacing washer and the upper plate is slightly smaller than the crystal.

piece holding the plugs so that the shank of the plug is exposed. Another hole in the spacing piece to match this, allows the spring to be inserted so as to make contact between the plug and lower plate. This form of mounting is sturdy, convenient and keeps the crystal free from dust and moisture. The authors wish to thank Mr. H. A. Chinn of the Round Hills Short Wave Research for the crystal mounting design and for his suggestions in the design of the transmitter.

Lieut. Davis S. Boyden, Radio Adviser to the Signal Officer, and in charge of Army-Amateur activities in this area, is very much pleased with the performance of this transmitter and wishes to express his appreciation of the valuable services rendered by members of the Massachusetts Institute of Technology Radio Club, in operating this station.

Strays

On Nov. 7th the Federal Radio Commission, in response to numerous representations of the A.R.R.L., revoked the amateur station licenses of the *San Francisco Examiner* and the *New York Times*, calls respectively W6ARD and W2UO. This is corrected an old injustice which has been fully explained in past issues of QST.

Although work is proceeding apace in the A.R.R.L. Technical Development Program, we regret that we have no article this month from the director of the program, Mr. Hull. The 28,000-kc. experiments at W1CCZ and other special work, to be announced soon, have conspired to make further writing impossible this month. The present activity in the program is on keying methods, on which an article may be expected in our next issue, along with a report on the 28,000-kc. work.

Station W1SZ was entered Election Night and two UV-204-A tubes were removed from their sockets and stolen, besides minor equipment. The serial numbers on the plate supports of the tubes are 22492 and 22175. It would be appreciated if anyone knowing the whereabouts of these tubes would notify Headquarters.

Paul S. Hendricks, late of the Stromberg-Carlson staff at Rochester and in charge of W1CCZ at Wianno, Cape Cod, for the owner, Mr. E. C. Crossett, during summers, has now joined the QST staff as assistant to Mr. Hull in the Technical Development Program, succeeding P. O. Briggs, W1BGF.

A Timely Suggestion

On page 94 of this issue, we've solved some of your Christmas problems for you. Take a look. And by-the-way, we'll accept last minute orders by telegraph and, if you say so, rush the card by special delivery.

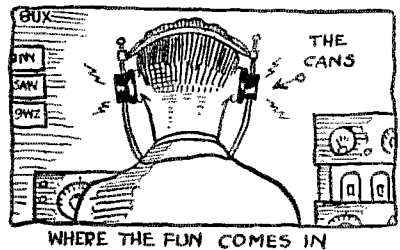



## An Improved Superheterodyne

By J. M. Grigg\*

**I**N the opinion of the writer, the chief disadvantage militating against the popularity of the super-heterodyne is the difficulty of design for single tuning. The inference from this statement includes, of course, that trouble with harmonics that too often creeps in to spoil an otherwise good job. The difficulty next in importance is that of finding a satisfactory frequency-changer. If a separate oscillator is used it seems like too many tubes. If one tried to economize space and equipment by using one of the dozen or so single-tube arrangements it is generally to meet an obstacle in some all-important detail. The trouble may be only that of broad tuning, or it may be inefficiency, or again it may be that bugaboo of harmonics, and if none of these, then it is something else.

If it is decided to operate the amplifier at a frequency just below the broadcast band, at one stroke, multiplicity of tuning, harmonics and all are eliminated. But in so doing the super-heterodyne is not doing what it is supposed to do; amplifying at low frequency for efficiency and at low beat difference for selectivity. Nevertheless after years of persistence this solution has seemed to the writer the only way out. Having decided, it remained then to find a satisfactory coupling and a one tube frequency-changer to go with it. For coupling the quest ended in the choice of a modified tuned impedance, this seeming not only the most stable, but also the most selective and efficient; and for frequency-changer one which, after several months of trial, appears to be flawless.

Using the frequency-changer and coupling referred to, two receivers have been built, in neither of which shielding was used, nor great spacing between apparatus allowed. One was a second harmonic, amplifying at 60 kc. and using a three-gang variable condenser to reflex a stage of tuned r.f. on the first i.f. tube. The other, amplifying at about 500 kc. is a one-spot receiver that has obsoleted all its predecessors.

The frequency-changer achieves the purpose desired by reason of the fact that the oscillating coil is coupled inductively instead of conductively to the grid, and is thus isolated from current-carrying portions of the grid circuit. Essentially, it

consists of a nominally free oscillating system,  $C_1L_1$ , Fig. 1, arranged to complete the coupling between the plate and grid circuits. In operation, oscillation is sustained by the agency of the system  $C_2L_2$  in action as a relay in the transfer of energy from the plate circuit to the grid coil  $L_2$ .

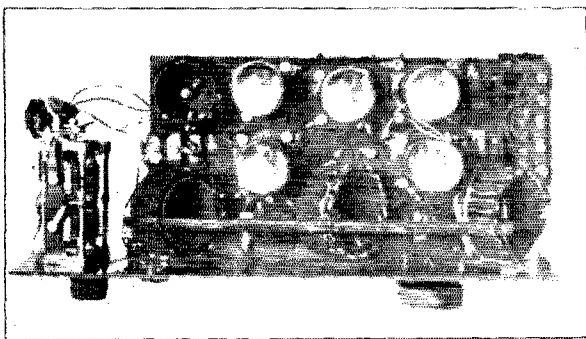

WHILE THIS SET LOOKS VERY MUCH LIKE THE TUNED R.F. RECEIVERS THAT WERE SO POPULAR AT ONE TIME, IT IS IN REALITY A SUPERHETERODYNE.

The three coils mounted at the familiar angle are part of the coupling units of the intermediate frequency amplifier. A single control, two condenser unit takes care of all the tuning and may be seen at the left. The large knob at the right is on the volume control rheostat in the filament circuit of the last i.f. stage.

The coupling of  $C_1L_1$  to the plate circuit may be direct, inductive, or capacitive, depending upon circumstances. If inductive, the coupling coil is interposed between the plate coil and the grid coil, the windings of the latter two running in opposite directions. Since direct induction between the plate and grid coils would cause an e.m.f. to be induced in the grid coil opposed in direction to the electromotive forces of both oscillating coil and loop, it is imperative that the mutual inductance between these two coils be small or negligible, compared with the mutual inductance between either of these and the coupling coil. This condition is provided for by proper arrangement of parts, the most obvious manner being the division of the coupling coil into two parts in non-inductive relationship, the plate coil coupled to one, the grid coil to the other, such as is shown in Fig. 1.

If a capacitive coupling is employed, as illustrated in Fig. 3, the latter need disappears automatically with the disappearance of one coil.  $L_1$ . In this case the capacity  $C_1$  of the amplifier also serves as coupling condenser in the frequency-changer.

\*5951 S. Tripp Ave., Chicago, Ill.

As to further advantages, it will be noted that in Figure 1 the input  $C_1L_1$  in series with the grid coil, has one end at filament potential as has likewise the oscillating system. This condition minimizes the static pick-up of energy, precluding body capacity, and in addition makes practicable the use of gang condensers with grounded rotors and pre-

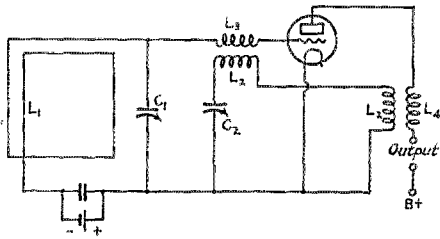

FIGURE 1. THE DIAGRAM OF THE COMBINED DETECTOR-OSCILLATOR

Plate detection is obtained by means of the high negative bias on the grid. The circuit  $L_2C_2$  determines the frequency at which the tube is oscillating and couples the plate and grid circuits together.

ceding r.f. stages on the same gang if desired. Maximum plate voltage and negative bias reduces grid damping to a minimum. Between the two tuned circuits there is no reaction that can be detected in tuning, and the system, thoroughly efficient, is absolutely consistent in operation.

The modified tuned impedance employed in the amplifier couplings combines hitherto disassociated principles in a manner of decided improvement. The input impedance is high, making for efficiency, while in a way to be explained, the circuit arrangement itself provides the means of keeping the plate at zero potential with respect to the grid, precluding oscillation. At the same time a further advance is made insofar as voltage ratios greater than unity follow as a consequence of the arrangement.

It will be observed that the capacity reactance which tunes the system to resonance, Fig. 2, is split into two parts,  $C_1$  and  $C_2$ , the plate tap being taken at the juncture, while direct current is fed to the plate through the choke r.f.c.

Comparing the input voltage with the total induced plate voltage it may be shown for any coupling that

$$\frac{E \text{ input}}{E \text{ plate}} = \frac{1}{1 + \frac{r_p}{Z_o}} \dots (1)$$

where  $r_p$  is the tube impedance, and  $Z_o$  is the input impedance of the coupling, considered at resonance. From this it is evident that the so-called tuned impedance

coupling has no voltage step-up in itself. Besides, since the input impedance is

$$Z_o = r + \frac{L}{C_r}$$

(very nearly), and in general extremely high, this coupling is both unstable and inefficient.

However, if the capacity is split into two parts, Fig. 2, then

$$Z_o = \left( r + \frac{L}{C_r} \right) \frac{C_2}{C_1 + C_2}$$

from which it may be shown by comparison that the input impedance is reduced in the ratio

$$\left( \frac{C_2}{C_1 + C_2} \right)^2$$

the frequency remaining the same. At the same time the potential across the coil, or secondary, is stepped up and may be caused to exceed the induced plate voltage. Expression (1) becomes

$$\frac{E_i}{E_r} = \left( \frac{1}{1 + \frac{r_p}{Z_o}} \right) \frac{C_1 + C_2}{C_2} \dots \dots (2)$$

which is the step-up ratio of the coupling.

The foregoing expression has no theoretical maximum; that is to say, it increases indefinitely with an increase in the capacity ratio. However, in design for high

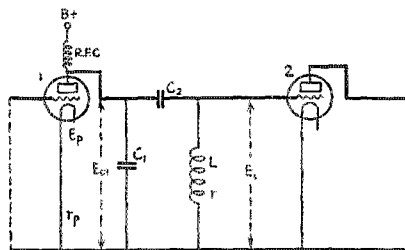

FIGURE 2 THIS SHOWS THE COUPLING ARRANGEMENT USED IN THE INTER-MEDIATE FREQUENCY AMPLIFIER

The circuit  $C_1C_2L$  is tuned to the intermediate frequency.

frequencies there is another consideration which determines the relative proportions of capacities to be used.

Traced in heavy lines in Fig. 2 is a circuit which includes in series the grid-plate capacity of tubes 1 and 2 and the capacity  $C_2$ . Due to the potential across the termin-

nals of  $C_2$  there is a tendency for a current to flow in this heavy line circuit. At the same time there is also a tendency for current to flow to the grid of Tube 1, due to the potential drop across the terminals of capacity  $C_1$ . Obviously, the resulting feedback potential impressed upon the grid of

band. Fixed condensers are used, where necessary, being adjusted to the inductance by having segments sawed off. The inductances themselves are ordinary r.f. coils, mounted so as not to couple.

As a matter of interest  $Z_0$  is about 125,000 ohms, and the values of the ratio, Ex.

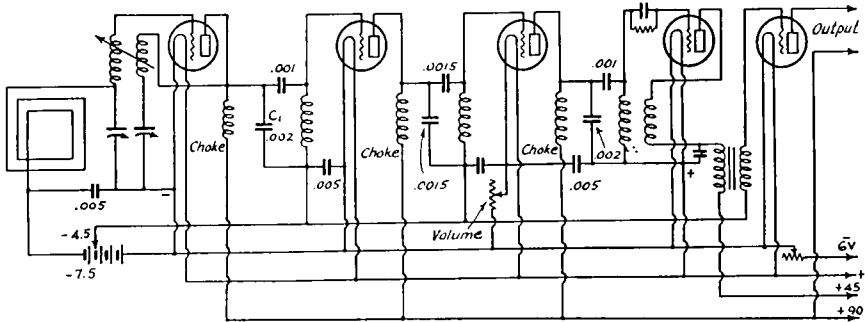

FIGURE 3. THE CIRCUIT DIAGRAM FOR THE FIRST DETECTOR-OSCILLATOR, TWO I.F., SECOND DETECTOR AND ONE AUDIO IS GIVEN ABOVE

Normal grid bias is applied to the i.f. tubes and some regeneration obtained by means of the tickler coil in the second detector circuit. The first detector employs plate rectification and the second uses a grid leak and condenser. The filament voltage of the second i.f. tube is varied as a means of volume control.

Tube 1 will be the vector sum of the potentials across  $C_1$  and  $C_2$ .

If the resistance of the inductance was negligible the potentials across  $C_1$  and  $C_2$  would be exactly opposite in phase. It may be demonstrated that in this case these opposite potentials would be of equal magnitude when  $C_1$  equals  $C_2$ , and the potential of the juncture point is sensibly zero with respect to the grid. From this it follows that in general a feedback to the grid will occur; positive when  $C_2$  differs numerically from and exceeds  $C_1$ , negative when  $C_1$  differs from and exceeds  $C_2$ .

Briefly, to sum up, the results of dividing the capacity are as follows: The input impedance is reduced, the secondary voltage is increased, and the potential of the plate with respect to the grid is sensibly zero when  $C_1 = C_2$ . Somewhat similar results may be shown to obtain if, instead of dividing the capacity, the inductance had been arranged in two isolated parts.

In practice the choice of equal values of  $C_1$  and  $C_2$  makes a rather close margin to build to. A slight deficiency in adjustment to frequency, or a certain unavoidable degree of magnetic coupling may cause oscillation. It is better to make  $C_1$  somewhat the larger of the two.

In the receiver illustrated the frequency is about 500 kc.—just below the broadcast

(2) are approximately 3 in the first, 2 in the second, and 3 again in the last coupling; and finally a few turns of wire in the detector plate circuit are coupled to the last inductance to secure regenerative effect.

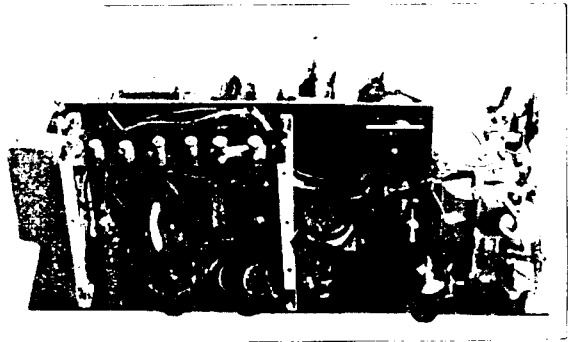

A LOOK UNDERNEATH THE SUB-PANEL

The coils wound on the square ended forms are r.f. chokes. The small shelf at the left carries the bias batteries. The audio transformer may be seen in the center just below the terminal strip. The small midget condensers are used to line up the two tuning circuits.

For tone quality, selectivity, sensitivity, and simplicity of tuning, the result is gratifying. Comparison with a low frequency super of known performance indicates that it has a comparable stage-per-stage amplification and sensitivity. And finally, it is single tuning, and as yet has not brought in a single station out of place.

# Straight-Edge Solutions

**I**N our endeavor to speak and think in kilocycles instead of meters we are constantly embarrassed because all our charts are based upon wavelength in meters. The result is that in calculating the range of a given coil and condenser, for instance, we lose as much time in converting the wavelength value obtained to its corresponding frequency, as is gained by the use of a chart requiring only the application of a straight-edge for the solution of the equation.

The two charts appearing herewith should prove of immense assistance in this matter. We are indebted to Mr. Allen B. Taylor, W6DXH for them.<sup>1</sup> From the chart appearing on this page, it is possible by means of a rule or other straight edge to find what values of inductance and capacitance may be used to obtain a given frequency range. It is also possible if the frequency range is not known to ascertain what it will be with a given inductance and capacitance. If the inductance and frequency range are known, the value of capacitance necessary may be obtained. It will, therefore, allow a rapid solution of your problem if it concerns inductance, capacitance and frequency of values within the range of the chart.

The frequency range of the chart is from 150 to 75,000 kc. with an inductance range of from .3 to 2,000  $\mu$ hy. Values of capacitance between 10 and 500  $\mu$ fd. are covered. In solving an equation in which there are two known and one unknown factors, it is only necessary to connect on the chart by means of any straight edge, the two known values. The unknown will be found in the third scale. Only one range of capacitance is shown although there are two ranges for both inductance and frequency. These are labelled "A" and "B". If the figures under "A" are used in one scale, those under that letter in the other should also be employed. From the other

chart we calculate the inductance of a given coil. In calculating the inductance of a coil, it will be necessary to know three things about it. These are: Its radius ( $\frac{1}{2}$  diameter); length in inches, and the number of turns of wire on it. Before you can find the inductance, there is one other figure that must be known. This is the value of "K" or the space factor. This is a correc-

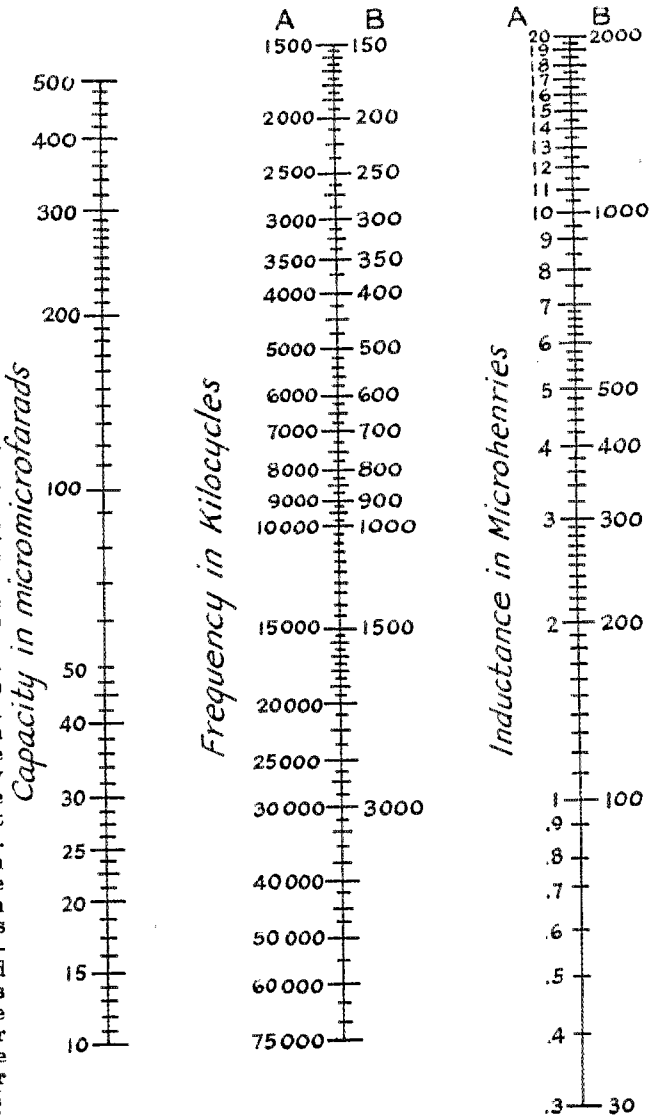

<sup>1</sup> Allen B. Taylor, Salt Springs Camp, R. Grand E. Co., Martell, Calif.

tion factor that allows coils of different shapes to be fitted into a formula based upon a particular shaped coil. Its value may be obtained from the curves in the

lower right hand corner. Supposing, for instance, that the coil is 3 inches long and 1 inch in radius (2 inches in diameter). If

(Continued on Page 36)

**NOMOGRAPHIC CHART FOR SOLUTION OF INDUCTANCE EQUATION**

$$L = \frac{.0029 V^2 n^2}{b} K$$

Where:

- L = Inductance microhenries
- r = Mean radius of coil (inches)
- n = Number of turns
- b = Length of coil (inches)
- K = Shape factor

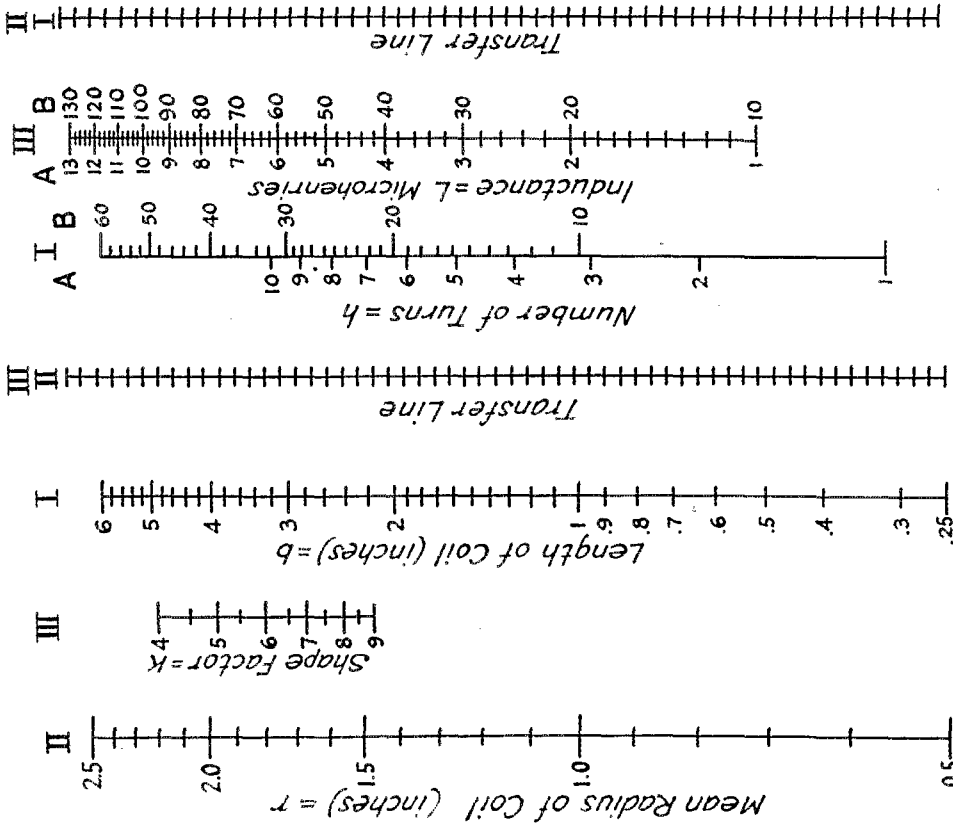
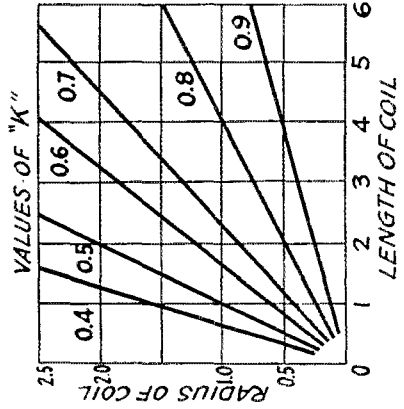

## Remote Control Relay

By Gordon Fixman\*

**T**HIS relay differs somewhat from the relays commonly used by the amateur in that current flows through the windings only when it is operated, none being necessary for the holding of the armature in position. It is simple in construction and can be made of the odds and ends that are usually found in the station junk box.

The unit consists primarily of an armature under spring tension that may be attracted to a magnet through which the operating current flows. After the arma-

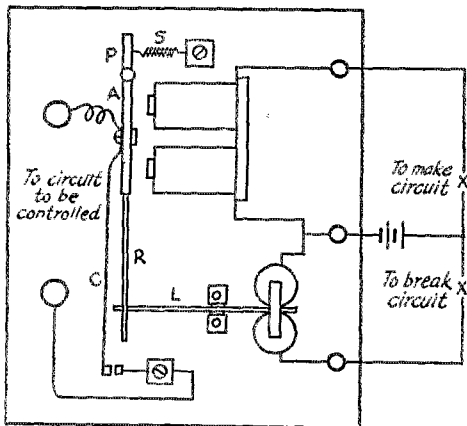

DIAGRAM OF THE RELAY

The armature A is pivoted at the point P and held away from the magnet by the spring S. The spring may be held in a binding post or a regular screw adjustment may be provided depending upon what is available.

ture has been drawn to the magnet, it is held in that position by means of a latch arrangement. To return the armature to its original position, a current is sent through a second magnet which releases the latch and the spring tension causes the armature to move back to the first position.

Two sets of magnets are needed and may be obtained from old bells. The armature A may either be pivoted or it may terminate in a short piece of spring material that is clamped to an upright post. If it is pivoted, the adjustment will be somewhat simpler. The contact arm C is bolted to the armature and should be of spring material so that the armature can travel somewhat beyond the point at which the contacts make. In

addition to the contact spring, a rod R is rigidly fastened to the end of the armature and in conjunction with the latch, holds the armature in position after it has been drawn to the magnet. In this particular case, the rod R was the original clapper on the bell from which the relay was made.

The latching device consists of a piece of brass or other metal mounted on a pivot so that when the rod moves under it, it will drop and hold it in place. To release it, current is passed through the magnet which lifts the latch and allows the armature to spring away from the magnet.

In order that the action of the latch is positive, it may be necessary to add a small weight to the end which holds the rod. If this is needed it may consist of a machine screw and nut with enough additional washers to make up the desired weight. A stop to prevent the latch from falling down to the base when the rod is not under it may be made by simply bending a piece of wire so that it will allow only a certain amount of movement of the latch. This wire may be fastened to the baseboard. Another method is to make the latch long enough so that even when the armature is as far from it as it ever gets, it will still rest upon the rod. This is probably the simpler method of the two.

The contacts which open and close the circuit under control may be made of any suitable material and the cross section will depend upon the current to be carried by them.

The relay may be operated from an a.c. source because the magnet is energized for

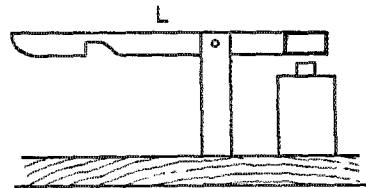

THE LATCH WHICH HOLDS THE ARMATURE IN THE "MAKE" POSITION IS SHOWN IN MORE DETAIL IN THIS SKETCH

such a short period of time and, what is of more importance, the pressure on the contacts does not depend upon the magnetic field as is the case with the commoner types of relays.

\*W9FEF, 3949 Magnolia St., St. Louis, Mo.

# Choke Coil Design

By Herbert F. Wareing\*

*There is a steady demand for information as to the design of special choke coils for filters and for use as Heising modulation reactors. To design a choke that will maintain its inductance when carrying direct current is somewhat troublesome. In the following article the author gives a design theory and shows its application to the modulator reactor of a radio phone set, because this is the most difficult case. This method does not require the assumption of core size, or the adjustment of air gap by trial.*

**I**N the minds of many operators a choke is just a choke—a large number of turns of wire wound around an iron core. It is a mystery how some chokes function as well as they do.

Some time ago the writer was requested to design a Heising modulation reactor for a 5,000-watt broadcasting plant and in view of the above did it with three ideas in mind:

A—To design a good reactor for this particular station.

B—To formulate and collect his own ideas of what a good choke should be and do.

C—To pass his ideas along through QST.

Many of the principles involved in that design are applicable to the design of any choke carrying a direct component of current and even to the transformer used in audio amplifying circuits. Some of the principles apply only to chokes or transformers carrying a wide band of frequencies superimposed on a direct current and since these points do not apply to the ordinary filter choke it would confuse the reader to attempt to discuss both the filter choke and the modulator choke at once. The discussion will therefore cover the most complete case; that of the modulator or Heising choke.

## THE DESIGN OBJECT

Since a design method can be introduced more easily in connection with an example we will take the case of the modulator reactor for a 5000-watt radiophone station which uses 5-kilowatt water-cooled tubes such as were made by the Kellogg Switchboard and Supply Company of Chicago. The normal voltage applied to these tubes is 10,000 and the current per tube is one ampere, therefore the current through the choke which operates at the position L in Fig. 1 is to be 2 amperes. The peak voltages between windings and core under normal conditions will run to 25,000 volts. It was suggested above that the modulator choke is a more difficult case than the filter choke. This is true because the frequency range to be covered is far greater and the frequencies

must be handled more nearly alike. This point deserves separate discussion.

## FREQUENCY RANGE

Whereas the filter choke is concerned with a small band of frequencies even ordinary speech requires a much wider band. In telephone work the frequency range shown in Fig. 2 is considered excellent for practical telephone conversation. (Anderson, Clement, DeCoutouly, I. R. E., Vol. 13, No. 4) This curve was made at the modulator reactor and does not show any distortion occurring in the oscillator and antenna circuits. The frequency characteristic required for

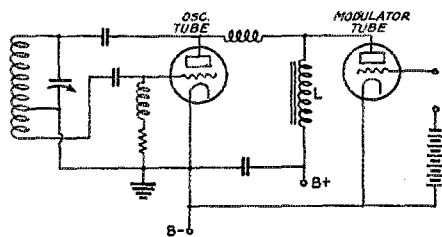

FIGURE 1

music is even more difficult. It seems to the writer that for very good transmission of music the frequency characteristic should be horizontal from 20 cycles per second to 10,000 c.p.s. The large organ pipes go down to 16 cycles, the bass drum has a very low fundamental, and the bass voice can go down quite low. Admitting that the low frequencies are felt as much or more than heard, why cheat the B.C.L. out of the feeling? It is part of the music. If a sound is composed of a fundamental and harmonic overtones, the fundamental and lower harmonics may be omitted and still the pitch and quality will sound the same. The missing frequencies are supplied by the ear, due to its non-linear characteristics. This is probably the reason that low frequencies are heard at all from most broadcasters on most receivers.

It is true that 5,000 cycles is the upper limit of fundamental frequencies produced

\*W9NY, W9FUZ, Instructor in radio, University of Wisconsin, Extension Div., Milwaukee, Wis.

by most instruments and it is also true that many broadcasting stations deliberately attenuate these high frequencies to cut down microphone hissing and other unpleasant noises. Many receiving sets do the same thing for the same reason. However, it is the higher overtones that provide the brilliance and "color" of music and the articulation of spoken words. The frequencies present

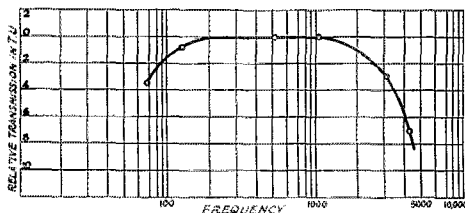

FIGURE 2

when the fricative consonants are spoken are very high; the characteristic frequency of the letter S is about 10,000 c.p.s. Many noises are composed of high frequencies entirely. The upper limit of hearing is between 10,000 and 20,000 c.p.s. depending upon the person. For these reasons a *desire* for a 10,000-cycle upper limit to the straight part of the curve does not seem extravagant. Our "most difficult case" therefore calls for a choke with a flat characteristic from 20 c.p.s. to 10,000 c.p.s.

It should be pointed out, however, that only a radiophone station wishing to transmit extremely pleasing music needs so wide a band. The ear cannot detect changes in volume of less than 10 percent and therefore it is also not necessary that the characteristic be exactly flat. In our example we are not considering engineering design, but scientific design. In other words we are looking for the best and not for the best at a specified price.

#### THEORY

It is of course necessary to be clear as to the work that the choke must do. Referring to Fig. 1 the choke coil L is the part of the equipment to be designed in this paper. The plate current for both the oscillator and the modulator flows through this choke coil.

The principle of Heising modulation is as follows: If the modulator grid is made less negative than normal, the modulator plate current increases. The decrease in plate resistance of the modulator lowers the total plate circuit resistance, which causes a larger current to flow through the choke from the plate source. This change in current induces a voltage in the choke, which

is opposed to that of the source, thus lowering the voltage applied to both plates. When the oscillator plate voltage is low, the plate current is low also, therefore the oscillations in the antenna circuit are feeble. Most of the current is now flowing through the modulator plate circuit because of its lowered resistance.

On the other side of the speech cycle the modulator grid is made more negative than normal, causing its plate current to decrease. The increase in modulator plate resistance now causes the total plate current to decrease, thus generating a voltage in the choke which aids the source, and which therefore increases the voltage applied to both plates. This increases the oscillator plate current, and the strength of the oscillations in the antenna circuit. Most of the decrease in modulator plate current appears as an increase in oscillator plate current, since the inductance of the modulator reactor tends to keep the total plate current constant. In this way the signal frequency variations of modulator grid voltage are changed to signal frequency variations of antenna current.

The variations of oscillator plate voltage affect the frequency at which the tube oscillates. Therefore, it is preferable to generate the radio frequency carrier in a tube with no modulation applied to it, and to modulate the power amplifier tube.

In Fig. 3 is shown the equivalent circuit of the choke and its associated apparatus, with the choke considered as a source of alternating voltage. This is in line with

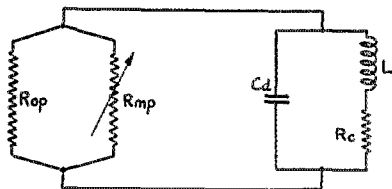

FIGURE 3

#### GENERAL DESIGN

the suggestion above that the effect of the choke may be considered as a source of momentary voltages added to or opposed to the normal plate voltage.

The induced voltage,  $e$ , of the choke is  $e = L di/dt$ .

We will for a moment consider the inductance L to be independent of frequency over the audio range. We desire the induced voltage  $e$  to be of the same amplitude at all frequencies, assuming the same modulator grid voltage. Then  $di/dt$  must be constant for all frequencies. With increase of fre-



quency, the current amplitude remaining the same, the rate of change of magnetic flux in the choke increases directly. We must therefore cause the current variations in the choke to decrease directly as the frequency increases. If the circuit contains only inductance this is done automatically because the reactance of the circuit varies directly with  $f$ . However we have the parallel resistances  $R_{mp}$ ,  $R_{op}$  and also the resistance of the choke in the circuit. The effect of these resistances can be seen in Fig. 4. It can be seen that the lower the circuit resistance the more nearly does the impedance vary as the frequency, also that with a given resistance this condition holds more nearly exactly as the reactance of the choke coil is increased. The use of small inductance and high resistance would discriminate against the lower frequencies which have already been seriously attenuated in the input amplifier.

From the foregoing we may conclude that the choke should be designed to have a minimum effective resistance which includes the

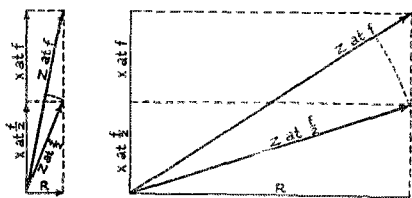

FIGURE 4

direct current resistance, skim effect, hysteresis and eddy current losses in copper and iron. An effective resistance increasing with frequency would not seem to be objectionable. Efficiency however demands a low power loss and low voltage drop in the choke. We may also conclude that the choke must have high inductance to minimize the discrimination against lower frequencies and the loss of modulator plate current variations through the choke.

MAGNETIC EFFECTS

It was assumed above that the inductance  $L$  was a constant quantity. However, the magnetic skin effect was neglected and this effect causes an apparent change of permeability of the iron with frequency. The actual permeability has not changed but the cross section of iron affected by the magneto motive force decreases, the flux being confined to the skin of the iron at very high frequencies. The reason for this depends on the fact that the fluxes produced by the eddy currents oppose the main flux in the laminations. Alexanderson (Proc. A. I. E. E., Vol, XXX, pp. 2433) stated that the apparent perme-

ability of soft iron strips .003" thick decreased to 10 percent of the normal at 200 kilocycles. If the magnetic skin effect decreases the active area of the iron in the choke, the inductance will also decrease at high frequencies. This will cause the degree of modulation to be lower at the higher frequencies and so introduce distortion. We may conclude that the core must be so chosen that the skin effect will not come seriously into play below our upper limit of 10,000 cycles. The obvious way to do this is to use iron so thin that the penetration will still be 100 percent at 10,000 cycles. It seems necessary also to exercise care in assembling the laminations to see that they are well insulated from each other in order to minimize eddy current losses and magnetic skin effect.

CAPACITY EFFECTS

We shall next consider the condenser  $C^d$  shown shunted across the inductance in Fig. 3. Whenever an inductance and capacitance are connected in parallel resonance occurs at some frequency and at this frequency the impedance of the combination is theoretically infinite and practically very high. In our case at the resonant frequency all of the variations in modulator plate current would pass through the oscillator while at all other frequencies some of the variation would escape through the choke. The equivalent circuit is shown as Fig. 5 in which  $R_{mp}$  is considered as a source of alternating current. We desire all of this current to pass through  $R_{op}$ , the oscillator plate circuit, without having any of it by-passed through the coil  $L$  or its distributed capacity  $C_a$ . This means a coil of high inductance and a condenser of small capacity. It is desirable to have the resonant frequency of the combination above the highest frequency to be transmitted, which is 10,000 cycles. Fig. 6 shows the current by-passed around the oscillator by

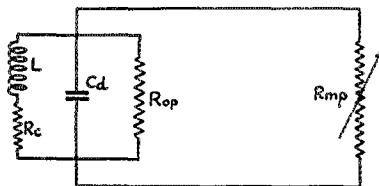

FIGURE 5

the coil-condenser combination at various frequencies. At low frequencies relatively large currents pass through the coil and at high frequencies relatively large currents pass through the condenser. It would appear that the effect of these shunted

currents would be to cause the phase angle of the low frequency currents to be shifted ahead and the angle of the high frequency currents to lag. If the power source has poor regulation a secondary voltage variation may be produced.

#### SUMMARY

We may conclude the reactor design shall have minimum distributed capacity consistent with reasonable cost, dimensions, weight and difficulty of construction. It must have low effective resistance, high inductance and thin iron with laminations well insulated.

#### CALCULATIONS

An inductance of 60 henrys was chosen as reasonably suited to the requirements mentioned above. The greatest alternating current will flow through the reactor at the lowest frequency and at 20 cycles the reactance of this inductance is 7500 ohms. The resistances in the circuit will not increase the impedance materially.

The tubes require a non-signalling plate voltage of 10,000 when delivering their rated output. If one hundred percent modu-

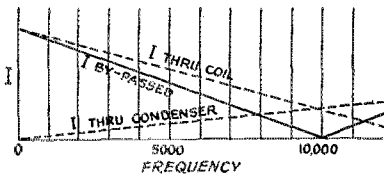

FIGURE 6

lation could be employed without distortion, the choke should generate an alternating voltage of  $10,000/\sqrt{2}=7000$  effective at all frequencies with maximum swing of the modulator grid voltage. This would cause the resultant plate voltage to vary from 0 to 20,000. Actually, 100% modulation cannot be reached without distortion due to the bend in the plate voltage, plate current characteristics at low plate currents. However, as no characteristics of the tube to be used are available, the choke will be designed for the worst conditions.

The greatest alternating current component of the reactor current will flow at the lowest frequency. This component will be  $E/Z=7000/7500=0.93$  amperes. The peak value of this current will be  $0.93\sqrt{2}=1.31$  amperes. The direct current through the choke is to be 2 amperes and the maximum instantaneous current will be 3.3 amperes while the minimum will be 0.7 amperes.

To show the relative largeness of these by-passed currents at the lower frequencies, we shall calculate these currents for higher

frequencies. At 1000 cycles the reactance is 376,000 ohms and the current will be only 0.018 amperes while at our highest frequency of 10,000 cycles the reactance is 3,760,000 ohms and the current but 0.0018 amperes, or less than 2 milliamperes.

In the choice of core material there are two important losses to be considered, the hysteresis loss and eddy-current loss. Both affect the effective resistance of the choke which we wish to be as low as possible. The eddy currents that flow in the core also cause the magnetic skin effect. The shape of the saturation curve is of great importance also. In addition to the above magnetic qualities another point to be considered is the procurability of the material.

The hysteresis loss is directly proportional to the frequency if the maximum flux density remains constant and to the 1.6 power of the maximum flux density if the frequency remains constant. In our case, as the frequency increases, the current and therefore the flux decreases. It would seem that the hysteresis loss would vary inversely as the frequency which in turn means that the effective resistance would vary inversely as to frequency which is opposite to the requirement derived at in the chapter on general design. For this reason we shall choose for our core a material having a low hysteresis loss.

The eddy current loss is probably independent of frequency. However, we wish to keep it as low as possible for two reasons. The first reason is that of keeping down the effective resistance and the second is because the magnetic skin effect is caused by the eddy currents. To minimize these currents the material should have a high resistivity and should be in the form of thin laminations.

The material that best fits the above specifications is 4% silicon steel of No. 29 U.S. Std. sheet gauge. It is 0.014 inches thick. Steinmetz gives the following formula for calculating the penetration of alternating flux:  $P=3570/\sqrt{\lambda\mu f}$ , where  $\lambda$  is the conductivity,  $\mu$  is the permeability, and  $f$  is the frequency. The resistivity of 4% silicon Follansbee steel sheets is given in the Standard Handbook for Electrical Engineers as 51.15 microhms/cm which gives a conductivity of 19,550 mhos/cm. The maximum permeability is given as 3,400. Therefore, the penetration

$P=3570/\sqrt{19,550 \times 3,400 \times 10,000}=0.00438$  cm., or 0.0111" at 10,000 cycles. Our sheets are, then, thin enough. Perhaps the ideal material from the standpoint of eddy current losses and the accompanying skin effect would be the compressed powdered iron cores used in carrier current work. However, it was not known where this material could be obtained in the required quantity in short notice.

The insulation between the laminations is well taken care of by the oxide on the sheet. Painting is not considered necessary as it only decreases the space factor of the core.

We must now turn our attention to the general shape of the core. At the frequencies used, the major portion of the distributed capacity is between layers and from end turns to core. For this reason a coil that has a short axial length and a deep radial depth will have the minimum distributed capacity, other factors remaining the same. This is because each condenser (layer to layer) has a smaller capacity, and because there are more of these smaller condensers in series. Another factor affecting the distributed capacity is the distance between the end turns and the core. The core brings the end turns of all layers and the inside layers electrically closer together, and therefore increases the capacity. For this reason a space will be left between the turns and the core, and between the inside layers and the core. This construction will require more iron and copper than if the choke were designed for the maximum space or weight economies, but is necessary to minimize the distributed capacity.

The capacity between layers will vary inversely as the distances between the copper of the layers. Double cotton covered wire could be used for this purpose, but as the turn-to-turn capacity is unimportant at audio frequencies, enamel covered wire may be used to decrease the total size of the choke. An insulating paper will be placed between layers, for the triple purposes of decreasing the distributed capacity, increasing the insulation, and making it possible to wind a smoother coil.

The size of the wire affects the distributed capacity, as well as the heating, the resistance, the cost, and the size of the choke. The larger the wire, the lower the resistance and heating, but the higher the distributed capacity, cost and size. A reasonable compromise between these factors is to calculate the wire size from the allowable temperature rise.

Another feature of construction that will decrease the distributed capacity is to wind the coils in pies, these pies being spaced from each other. This will also allow of tapping different values of inductance into the circuit if such a thing should at any time be found desirable. If an even number of pies is used, it will allow connecting the two halves in parallel, thus adapting the choke for use with tubes operating at heavier currents and lower voltages.

Let us calculate the distributed capacity that is allowable to bring the resonant period of the choke to the highest frequency used. Resonance obtains when  $\omega L = 1/\omega C$ , or resonant frequency  $f = 0.159/\sqrt{LC}$ , where

L is in henries and C is in farads. For  $f = 10,000$  cycles then,

$$\sqrt{C} = 0.159 / (\sqrt{60} \times 10,000)$$

or  $C = 0.000042$  microfarads or only 4.2 picofarads. A glance at the size of this figure will convince anyone of the necessity for the stress that has been placed on this feature of the design, and the care that will be required to bring the resonant hump up near the high end of the useful frequency range. It must also be remembered that the

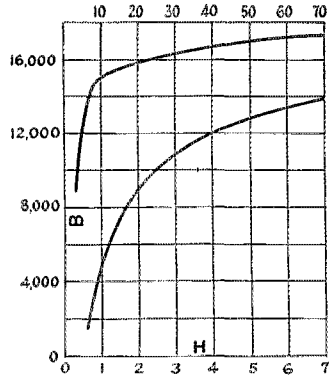

INDUCTION CURVE OF FOLLANSBEE SHEETS  
FIGURE 7

blocking condenser, tube capacities, and the like, are also in parallel with the choke for audio frequencies.

With the above points in mind it can be seen that a choke of the core type can be built to have less distributed capacity than one of the shell type.

We shall now turn our attention to the flux induced by the current flowing through the coil. A saturation curve for the material decided on is shown as Figure 26 Sec. 4 of the Standard Handbook. This curve is reproduced roughly as Fig. 7. We wish to work over as straight a portion as possible of this characteristic for the same reason we wish to confine the operation of a tube to the linear portion of its characteristic. For this reason, and still working the iron as high as possible to keep down cost and size, a flux density of 80,000 lines per square inch maximum seems reasonable. The current corresponding to this flux density is the maximum instantaneous current, which was calculated above to be 3.3 amperes.

On the linear portion of the magnetization curve of the iron with air gaps the flux is proportional to the current. Therefore the ratio of the maximum current to the minimum current is the same as the ratio of the maximum flux to the minimum flux. From this relation we find that the minimum flux will be  $80,000 \times 0.7/3.3 = 17,000$  lines per square inch. This confines the operation,

even at the lowest frequency where the current swing is large, to the fairly straight portion of the curve.

This fixes the normal or non-signalling value of flux to the average of the above two figures, which is 50,000 lines per square inch induced by the d.c. component of choke current producing no e.m.f.

In Figure 8 is shown a sketch of the core. The cross section of the core is square and "a" inches on a side. The window area is bh square inches.

The fundamental equation for e.m.f. in the transformer is  $E=4.44fT\phi 10^{-8}$  volts, where E is the effective value of a sinusoidal voltage, f is the frequency, T is the number of turns in series and  $\phi$  is the peak value of the alternating flux. The peak flux density was calculated above to be 30,000 at a frequency of 20 cycles. We shall denote this flux density by B.

The total flux is equal to the flux density times the cross sectional area of the iron. The space factor of the iron is, as usual, assumed to be 0.9, the other 0.1 of the cross section being taken up by the insulating oxide, etc. Therefore  $\phi$  in our case is  $0.9Ba^2$ .

Our voltage equation now becomes  $E=4.44fT0.9Ba^2 10^{-8}$  which reduces to  $E=4fTb_a^2 10^{-8}$ . If we now multiply both sides of this equation by the current I, we obtain  $P=4fITb_a^2 10^{-8}$ . In this equation there are two unknown quantities, T and a. We must eliminate one of these unknowns to solve the equation.

We shall eliminate T as follows: A safe value for the current density U in the wire is about 1,000 amperes per square inch. There will be a certain ratio between the actual copper area in the window and the win-

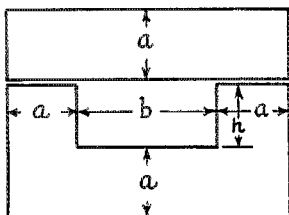

FIGURE 8

dow area. This ratio is called the space factor for the window, and is denoted by K. Because of the large part of the window area taken up by insulation in our case, we shall assume this space factor K to be 0.25, although it may be as small as 0.12. Then the product Kbh gives us the area of copper in the window, which when multiplied by the current density U gives us the total number of ampere turns IT.

Therefore we can substitute for IT its equal KbhU. This changes the equation to

$P=4fBa^2KbhU 10^{-8}$ . The power, P, is the product of the alternating effective voltage and the direct current through the choke. We now have three unknowns in the equation, but these three quantities are all dimensions of the core and can be expressed in terms of each other. Our equation now becomes  $a^2bh=(P10^8)/(4B,KUf)$ .

We must now decide on the relation between a, b and h. From our remarks above concerning distributed capacity, we conclude that reasonable dimensions will be  $h=a$ , and  $b=2a$ . Therefore our equation finally becomes  $2a^4=10^8P/4B,KUf$ . Solving this equation,  $2a^4=(7,000 \times 2 \times 100,000,000)/(4 \times 30,000 \times 0.25 \times 1,000 \times 20)=2,333$ , or  $a=5.84''$ . We shall use 6 inches for a, 6 inches for h, and 12 inches for b.

The original voltage equation when solved for T becomes  $T=10^8E/4.44f\phi$ . Solving this equation, the number of turns necessary on the choke is  $T=(7,000 \times 10,000,000)/(4.44 \times 20 \times 30,000 \times 0.9 \times 36)=8,630$  turns. This number of turns will be distributed between two legs, so the number of turns per leg will be 4,300. Two pies will be used on each leg, so the number of turns per pie will be 2,160.

The next step is to calculate the size of wire to be used. The direct current through the choke is to be 2 amperes, and the current density assumed above was 1,000 amperes per square inch. The cross sectional area of the wire will then be 0.002 square inches, or 2,546 circular mils. The nearest commercial size to this is No. 16 B. & S., which has an area of 2,583 C.M. This is well, because the heating varies as the square of the current, and therefore the current producing the heating when signalling is greater than 2 amps.

The next thing we wish to know is the thickness of the insulating tubes and flanges required. Bakelite was chosen for the sheet material, because of its easy procurability. The Stnd. Handbook gives the dielectric strength of this material as 600 volts per mil. As we wish to insulate this choke for 25,000-volt peaks during normal operation, the thickness required will be  $25,000/600=0.05''$ . With a factor of safety of 5,  $1/4''$  material will be required. This thickness is also necessary for mechanical strength. It must also be kept in mind that very high voltages are induced in a choke of this type when tube failures occur, and the insulation should be designed accordingly. The core of the usual type of choke saturates at currents slightly above normal (often below), and therefore high voltages cannot be produced.

Much ingenuity may be used in the insulation design, as square and round insulating tubes of the required sizes are rarely manufactured. Therefore this feature will be left to the individual builder. In addition to the insulation, air spaces

(Continued on Page 74)

# Debunking Crystal Control

By J. Herbert Hollister\*

**W**ITH the big jam which becomes effective January 1st almost upon us, it seems timely to point out one big fact concerning crystal control which has been sadly neglected. To wit: Its utter simplicity. When piezo-electric oscillators were first brought to our attention, the whole thing seemed woefully complex. Crystal articles with their multi-tube circuits almost seemed to invite one to try something else. But the desirability of that beautiful flute-like ping, which comes only from the quartz plate, would not down and now we find that the thing is not so very difficult after all.

Today, with two 210's and two crystals, the writer is enjoying all of the thrill of many long chats and some good foreign contacts with none of the grief which seems to go hand in fist with high power.

Until recently it has been something of a problem to acquire the necessary bit of vibrating rock. Prices have been high for finished crystals and good blanks have been scarce. Then, too, there has been that mental hazard, the feeling that to successfully grind a plate and get it to oscillate somewhere near where one wanted it to, was almost a bit of black magic.

But now, excellent 3500-kc. plates may be obtained for a reasonable sum, and for those who prefer to "roll their own" there are plenty of tested and guaranteed blanks available, the completion of which is neither complicated nor difficult.

## GRINDING THE CRYSTAL

The one absolute necessity for the grinding job is a micrometer caliper with which to gauge the thickness, and most of us can usually borrow such tools in a pinch. A few scraps of almost any kind of glass, some No. 120 carborundum or alundum grain for the rough grinding, and some FF or FFF ditto for the smoothing-up job completes the layout.

The blank you buy should have one side finished when you get it, and a statement as to the axis on which it was cut, or better, a notation of its thickness factor. The writer has found that plates cut on various axes run from 2.6 meters to 8.9 meters per thousandth of an inch in thickness. Then, given this factor to start with, it is only necessary to multiply the thickness of the plate in

thousandths of an inch by the factor in order to arrive at the approximate wave length in meters.

With the micrometer, measure the thickness of the blank at each corner and in the center and mark the thickness directly on the crystal with a pencil. Then dump a bit of the coarse abrasive on a piece of glass and mix a few drops of water with it, spreading the gunk around with a finger. From here on, it is simply a matter of bearing down on the blank and rubbing it around on the glass, checking with the micrometer until approximately the desired uniform thickness has been reached.

Next comes the fine abrasive and another piece of glass with more frequent applica-

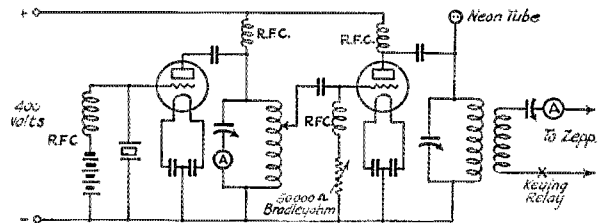

**THE WIRING DIAGRAM**  
Both the crystal and amplifier tubes are 210s, the amplifier being operated as a frequency doubler. Plate and filament supply is obtained from a Thordarson No. 2088 transformer. By means of plug-in crystals and plate inductances, operation may be had on either the 3500- or 7000-kc. band. The neon tube connected to the amplifier plate tank circuit indicates when resonance is obtained. In this particular case, it is possible to key in the antenna feed line, the transmitter running constantly.

tions of the micrometer, until your plate oscillates at the desired frequency.

Maximum output may not be obtained if the variation in thickness exceeds .0002" in the 3500-kc. region and .0001" in thinner plates. The writer has found cases where the output was materially boosted by grinding the middle of the plate about .0001" thinner than the edges. This is best done in grinding by applying pressure in the center with the craser on the wrong end of a pencil. The edges may be cleaned up and slightly beveled on a carborundum stone or an oil stone of most any kind.

## PLUG-IN CRYSTAL MOUNTING

The need for a small, inexpensive dust-proof crystal holder of the plug-in type had been felt here for a long time before the idea finally occurred to the writer that such a gadget might be assembled from ordinary work shop scraps.

First a piece of ¼" bakelite was squared up to 1½" on a side, and then a 1" square

\*W9DRD, Lake Forest Club, Edwardsville, Kansas.

was cut out of that with a coping saw, (genus five and tenus) leaving a  $\frac{1}{4}$ " rim of bakelite, with a hole in the center large enough to accommodate a crystal slightly less than 1" square. Then a piece of  $\frac{1}{16}$ " brass was cut out and squared up to just fit the  $1\frac{1}{2}$ " square of bakelite, and fastened to same with four 3-48 machine screws, thus forming the bottom plate of the holder.

In one side of the bakelite rim two holes were drilled  $\frac{1}{4}$ " apart and tapped to receive 6-32 General Radio plugs. One of these plugs was cut off so that it did not extend through the bakelite, and was connected to the bottom plate of the holder by means of a piece of light spring brass.

The other plug was allowed to extend just through the bakelite, so that a narrow strip of .001" shim stock could be soldered to it and then to the center of the top plate, making the other contact. The top plate is a brass slug of the type used in the manufacture of brass tags, but any light metal disc will serve as well. It rests on the crystal of its own weight.

The cover is a  $1\frac{1}{2}$ " square piece of  $\frac{1}{16}$ " brown bakelite which was used only because the writer once bought a sheet of the stuff

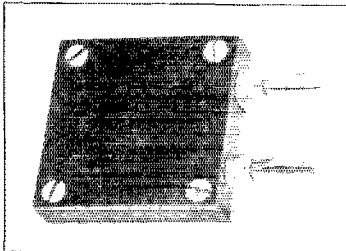

THE CRYSTAL MOUNTING

The crystal lies on the lower plate which is of brass. The upper plate rests on the crystal and is connected to the plug by means of a piece of shim brass. The top of the case is of bakelite as is the spacer to which the top and bottom are fastened. In this particular mounting, eight screws were used to hold the two plates to the bakelite spacer. They are located at the corners and each screw goes half way through the bakelite spacer. It might be somewhat stronger to drill clearance holes in the bakelite pieces and thread the brass plate, using but four screws for the job.

and never could find a use for it before. Of course any sort of thin sheeting may be used here as it is only a dust cover.

One item of importance is the preparation of the contact surfaces of the two electrodes. The face to be used was first smoothed down with emery cloth held flat on a piece of plate glass, then ground with powdered pumice and water on a plate glass lap, in the same way that crystals are ground. The pumice does not dig in and ride around with the brass like carborundum. If doubt exists as to the flatness of the surface, a bit of Prussian blue on plate glass will show up the high spots on the brass.

By using one of these mountings for each crystal in general use here, with the frequency engraved on the cover, the writer has been able to dispense with all of the fuss and bother of washing the crystals and

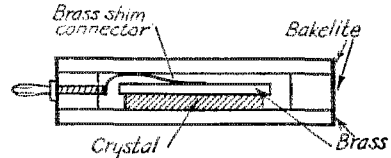

THE COMPLETED CRYSTAL MOUNTING IS SHOWN ABOVE

It is resting on the lower brass plate which is the proper position for operation. The small piece of shim brass making contact between the brass plate and the GR plug may be seen. The other contact is made internally.

has reduced the breakage hazard to a minimum.

Much confusion has been caused by the r. f. ammeter in the crystal tank circuit. The output of the crystal is a matter of wattage, and the current in the tank is of course dependent upon the r. f. resistance present; our old friend, the L-C ratio again.

The accompanying sketch depicts the writer's pet layout in its present stage of development and the proof of its effective simplicity lies in the fact that it worked beautifully the first time the key was pressed. Since that time a perfectly good Armstrong rig with its 852 has just been in the way.

## Straight-Edge Solutions

(Continued from page 27)

we follow the horizontal line for 1-inch radius until it meets the vertical line for 3 inches in length, we find that they meet just about half way between the 0.7 and 0.8 diagonal lines. This means that the shape factor will be 0.75.

The next step is to connect together with a straight edge, those scales that have like Roman numerals at their top in the order in which they are numbered. Thus we start by connecting the scales for the length of the coil and its number of turns because these are labelled I. The point at which the rule crosses the transfer line under the numeral I is indicated by a dot and the rule run between that point and the radius scale labelled II. We mark its position on the transfer line, II, projecting from this to the space factor scale, III, finding our answer on the inductance scale, III. Thus, knowing three facts about the coil and performing four simple operations, it is possible to calculate the inductance of it.

—H. P. W.

# Regenerative Coupling Devices in Audio Amplifiers

By J. K. Clapp\*

FOR purposes where highly selective amplifiers are desired, the arrangement herewith described is of considerable interest. This particular circuit is an extension of the familiar amplifier shown in Figure 1. With the tuned circuit LC of Fig. 2A is associated the vacuum tube 3 and the tickler coil L1, by means of which the effective resistance of the tuned circuit LC may be greatly reduced at and near the resonant frequency of the circuit. The use of such a regenerative network in connection with the suppression of a single frequency in audio frequency measurements has been described by J. A. Stratton.<sup>1</sup> Here the inverse application is made to build up a high amplification at a single frequency. The amplification here considered is given by the ratio of  $V_2$  to  $V_1$ , that is, the ratio of

This amplification is many times considered as a function of the load  $Z_p$  as plotted in Fig. 3. Consideration of Equation 1 shows that if  $Z_p$  is much greater than

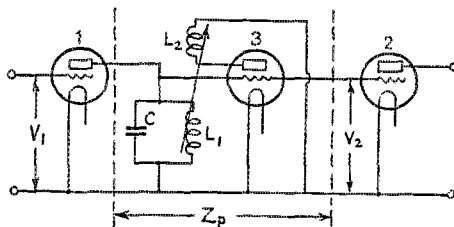

FIG. 2A

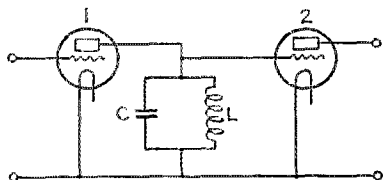

FIG. 1

the voltage appearing between the grid and filament of tube 2 to the voltage impressed between grid and filament of tube 1.

### CONCEPT OF OPERATION OF AMPLIFIER

In discussing the circuit arrangement, it is convenient to think of tube 3 as an essential element of the impedance network which is associated with the plate circuit of tube 1, as shown schematically in Fig. 2B. For such an amplifier, the amplification is given by:

$$k = \frac{\mu}{1 + \frac{r_p}{Z_p}} \dots \dots (1)$$

Where:

- $\mu$  = amplification of tube 1.
- $r_p$  = its dynamic internal plate circuit impedance.
- $Z_p$  = impedance of plate circuit load.

$r_p$ ,  $k$  approaches  $\mu$  as a limit. In such cases, no consideration is given to the possibility of giving to  $Z_p$  the characteristics of a negative resistance. If the quantity  $r_p$  over  $Z_p$  be given values lying between 0 and -1., it is seen that  $k$  may become very large.

To consider this in detail it is convenient to rearrange Equation 1 as follows:

$$\frac{k}{\mu} \left( \frac{r_p}{Z_p} + 1 \right) = 1 \dots \dots (2)$$

which is seen to be the equation of a hyperbola, with its center at (-1,0), when  $k$  over  $\mu$  and  $r_p$  over  $Z_p$  are taken as variables.

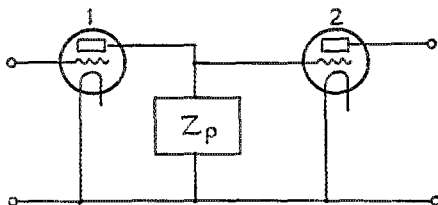

FIG. 2B

This function is shown in Fig. 4. This graph is of considerable interest since it indicates that the amplification goes through no discontinuity or abrupt change as the plate load is given extremely large positive or negative values.

\*Formerly instructor in the Communication Laboratory of the Mass. Institute of Technology. Now with the General Radio Company of Cambridge, Mass.

1. "Complete Suppression of a Single Frequency by Means of Resonant Circuits and Regeneration," J. A. Stratton, J. O. S. A. and R. S. I., Vol. 13, No. 1, July 1926, pp 95-105.

The concept of a negative resistance as equivalent to the effect of regeneration is

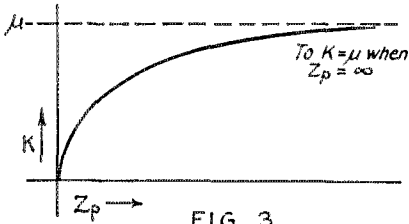

FIG. 3

well established, though sometimes questioned.<sup>2</sup> The idea here certainly seems straightforward and yields a ready interpretation of the performance of the circuit. Consider now the tuned circuit LC in which the series resistances of the elements are indicated, as in Fig. 5, with the effect of the regenerating tube at the resonant frequency represented by the negative resistance  $-R$ . By varying the coupling between  $L_1$  and  $L_2$  the value of  $-R$  may be varied through a wide range. If  $-R$  is sufficiently large, the impedance between A and B is a negative resistance at resonance, the value of  $r_p$  over  $Z_p$  being a small negative quantity. The effective amplification under these conditions is essentially equal to the amplification factor  $\mu$  of the tube 1. If now the

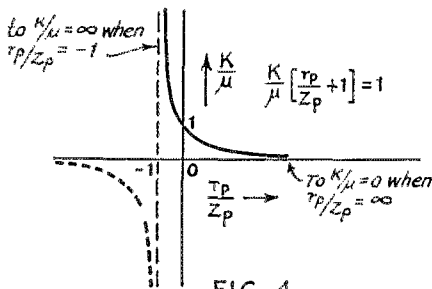

FIG. 4

negative resistance  $-R$  is increased, the impedance between A and B, Fig. 5, decreases in magnitude, remaining negative in sign and as a consequence of Equation 2, the amplification  $k$  increases. As further increases in  $-R$  are made,  $k$  continues to increase, approaching infinity as  $r_p$  over  $Z_p$  approaches  $-1.0$ .

Viewed from the regenerator, Tube 3, the impedance AB is constituted as shown in Fig. 6. The resistance of the series circuit LC, includes the equivalent effect of the positive resistance  $r_p$  shunted between its terminals, as represented by  $r_p'$ . As long as the network is to remain stable (the regenerator not producing self-sustained

oscillations) the sum of the effective resistance taken around the LC loop must be positive.

Thus it is seen that when the coupling network (circuit LC and Tube 3) is treated as an impedance placed in series with the plate circuit of Tube 1, the impedance of LC is a negative resistance at resonance. When viewed from the regenerator, Tube 3, this circuit has at all times a net positive resistance. That this viewpoint has a physical significance is readily demonstrated experimentally by removing the first tube

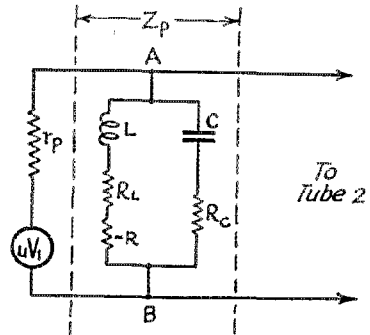

FIG. 5

from shunting LC, which is equivalent to short circuiting  $r_p'$  of Fig. 6. For a value of  $-R$  which is stable when  $r_p'$  is in the circuit, the regenerator will maintain self-generated oscillations when  $r_p'$  is removed.

EXPERIMENTAL RESULTS—SINGLE FREQUENCY

At frequencies of the order of 1,000 cycles per second, using an inductance of approximately 0.10 henry for  $L$  and a tube of  $\mu=8$  for Tube 1, it has been possible to obtain amplifications of the order of 160 or  $k$  over

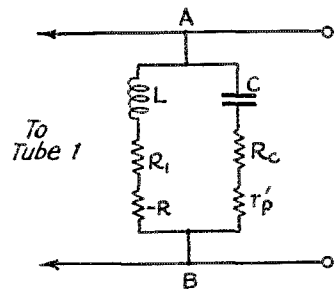

FIG 6

$\mu=20$ . Amplifications of the order of 80 to 100 are readily obtained with no instability. The curves of Fig. 7 are plotted

2. See E. H. Armstrong, Proc. I. R. E., 3, p. 215, 1915. Ballantine, Radio Telephony for Amateurs, p. 208. Miller, B. S. Sci. Papers No. 351.



from experimental data and strikingly indicate the tremendous increase in amplification obtained at resonance as well as the extreme selectivity of the arrangement.

AMPLIFICATION OF SEVERAL INDIVIDUAL FREQUENCIES

An amplifier of this type may be easily arranged to respond to two or more frequencies while using but one regenerator tube as shown in Fig. 8., yielding a response/frequency characteristic as shown in Fig. 9. If the tuned circuits are made

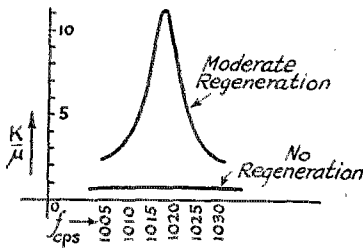

FIG 7

to have the same effective impedance, by adjustment of the mutual inductances  $M_1$  and  $M_2$ , the peaks of the response curve will occur at the same value of amplification. If the impedances are not of the same magnitude, the response curve will take the form shown by the dotted lines.

BAND-PASS AMPLIFIER

By bringing two or more peaks of the same amplitude close together by adjustment of the values of  $L$  and  $C$  in the tuned circuits, a band-pass amplifier may be arranged. When high values of  $k$  over  $\mu$  are employed, the width of the band is very narrow, but for moderate values of  $k$  over  $\mu$  an appreciable gain in the width of the band of frequencies, over which fairly high amplification is obtained, is possible.

APPLICATIONS

In the heterodyne reception of radio telegraph signals, from constant frequency

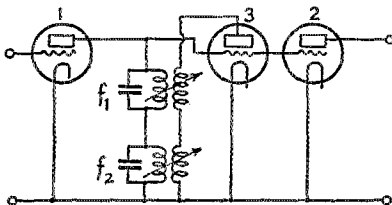

FIG. 8

transmitters, such amplifiers provide a high degree of selectivity based upon the selec-

tion of a desired audio frequency beat tone. Further, the peak amplifications per stage, obtainable by this method, exceed those obtained in transformer coupled, audio frequency amplifiers of commercial design.

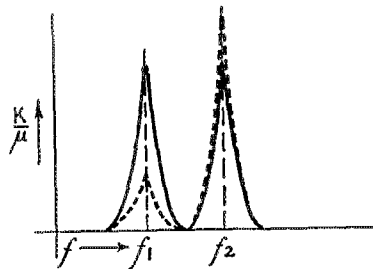

FIG. 9

A single stage of this type working into a suitable power amplifier tube provides a means of practically eliminating harmonic frequencies from a low power source, as used for bridge measurements.

In various control problems, selection of a desired operation, on the basis of frequency selection via modulated radio waves, or via the audio frequencies as transmitted over wires, is readily obtained. If the tube following the amplifier is made to operate a relay, this relay will operate only when the resonant frequency of the amplifier is impressed upon the amplifier. Several such relays may be operated by a relatively narrow band of control frequencies.

ACKNOWLEDGEMENT

The author is indebted to Professor E. L. Bowles for suggestions and construc-

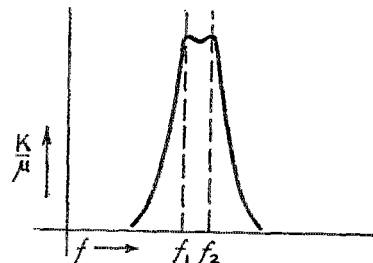

FIG 10

tive criticism of this work and to Messrs. Houghton, Whittaker, Hall and Krantz, for experimental data obtained during their course of study in the Communication Laboratory.

## Relieving The Glass Arm

By Charles A Hill\*

IT may be said in justification of this paper that during several years of experience in radio operating the writer has seen and read many treatises concerning the proper manipulation of the telegraph key, but he has yet to find a single article dedicated to the victims of telegraphers' paralysis, known in radio parlance as glass arm. It is for the benefit of these unfortunate individuals that this paper is presented. It must be understood from the first, however, that the suggestions set forth herein are not offered as a "cure" for this condition but rather as a system of procedure which, if diligently practiced, will in all probability relieve it to degree dependent upon the particular case.

Let us begin by differentiating between telegraphers' paralysis, in its true sense, and permanent fatigue; the latter being the result of years of labor at the key and the consequent wear and tear on the arm muscles.

Glass arm, as we shall designate this condition in future reference to it, is a condition in which the muscles of the forearm become tense and the wrist stiff and almost uncontrollable whenever the sufferer attempts to use an ordinary telegraph key. In nearly all instances the cause of glass arm may be traced to the improper use of the key at some period in the individual's operating experience. The method known as "nerve sending," so often attempted because of its speed and resemblance to the style of sending characteristic of semi-automatic keys, is responsible for many cases of glass arm. Nerve sending, as the term implies, is dependent, to a great degree, upon the constant tightening of the muscles of the forearm in order to make a series of dots, which are necessary in the formation of certain characters. The results of such a method of sending are at first very gratifying; but if it is persistently employed, the operator is very likely to find himself with a stiff arm, the wrist motion of which he cannot control.

One must bear in mind that when using the ordinary telegraph key, each character of any combination should be made with a definite motion of the wrist; the wrist gaining its impulse from the muscles of the forearm. That is why the forearm should touch the table at only one point and the wrist be held so as not to touch the table at all. Besides being the best position from an operating point of view, it is at the same time the most natural and comfortable.

In order to give the proper time value to each of the characters as well as the proper spacing between them, it is essential that the muscles of the forearm and wrist be absolutely relaxed. An excellent test for this is to try sending a series of twenty-five dots without slurring and with equal intervals between them. Inability to execute this test exercise smoothly is an indication that something is wrong with the method of handling the key, thus preventing the proper relaxation of the arm muscles.

The old maxim which says that good work is impossible with inferior tools is just as true in this case as in any other. The best sending arm in the world would be handicapped by using a key with poorly fitted bearings and pitted contact points. The best results can be obtained by using a key with bearings that may be tightened to the point where there is no side play and at the same time permit a free vertical movement of the key arm. The other part of the practice set is, of course, the source of sound. Any device that may be controlled by the key and that emits a smooth note is suitable. A high-frequency buzzer is recommended, the preference being due to its great economy of operation. With this apparatus connected to an adequate source of current supply, we are ready to begin "working over" the glass arm.

The best adjustments of the key with which to begin are those which allow the key knob to travel through an arc of about one eighth of an inch, at the same time maintaining a fairly stiff spring tension. These recommendations are not inflexible, however, and may be varied to suit individual requirements. These two adjustments are very important factors in overcoming the tendency to send a series of dots by tightening the muscles of the forearm, the disadvantages of which were emphasized in a previous paragraph.

It is well to begin each period of key practice with the sending of several series of dots, twenty-five dots in a series, carefully executed so as to be evenly spaced; keeping in mind that the arm must be relaxed and not permitted to become strained in any part. It may be found that frequent rest periods are necessary at first in order to maintain this relaxed condition, and complete relaxation at all times is of the utmost importance. After sending the series of dots several times, the operator will find himself becoming familiar with the "feel" of correct sending procedure. Each dot and

\*W6BRO, 286 S. Fedora St., Los Angeles, Calif.

(Continued on Page 78)

# A Frequency Meter Combined with Your Receiver

By Eugene C. Woodruff\*

**S**AY, fellows, when you rebuild your receivers for 1929 just what improvements are you aiming at? Of course it's fine to better the design and workmanship, yet if that's all you do, just how will that improve your operating? Why not add something to the receiver that will increase your operating control to an undreamed of extent. And that without interfering in any way with your present preferences for receiver construction, or with any other changes you may wish to undertake. In order of importance the list of desirable improvements might run thus:

1. More delicate and stable means of controlling regeneration, and therefore increased audibility.
2. Similar control of beat note pitch, and therefore increased selectivity.
3. More convenient means of measuring frequencies, and therefore increased ease and certainty in schedule work.

The item that will give all these advantages is simply a frequency meter built into the receiver assembly, and capacitively coupled to the plate of the detector tube. This will not interfere in the slightest with any other items you may wish to adopt, such as screen-grid tubes, etcetera. The accompanying photos and diagram show the receiver as used at W8CMP. The coil-condensator combination at the right is the frequency meter. The rest of the outfit is a conventional detector, 2-stage receiver but with certain individual features.

A milliammeter in the plate circuit of the detector tube serves to show when the frequency meter and receiver are in resonance, and also the extent to which the frequency meter is controlling regeneration. If it is not convenient to install such a meter, the frequency meter, coupling condenser may be adjusted so resonance will be indicated by a click in the phones, and the regeneration control by the change in beat note pitch.

The set is wholly self-contained and shielded, when using 199 tubes. The spacings are adequate in the design and 201-A tubes may be used instead by plugging in a

suitable "A" battery in the left hand jack. This cuts out the inside "A" battery. Even when using 199 tubes it may be advisable to plug in a larger outside "A" battery to save the built-in battery for strictly portable use.

The front and ends of the aluminum case are in one piece. The back and bottom are readily detached giving easy access to all items.

The pin jacks in the left end are for antenna and ground. The antenna coupling is easily varied by swinging the coil in the Fahnestock clips, shown in photo of the interior.

When the tickler coil, by-pass condenser,

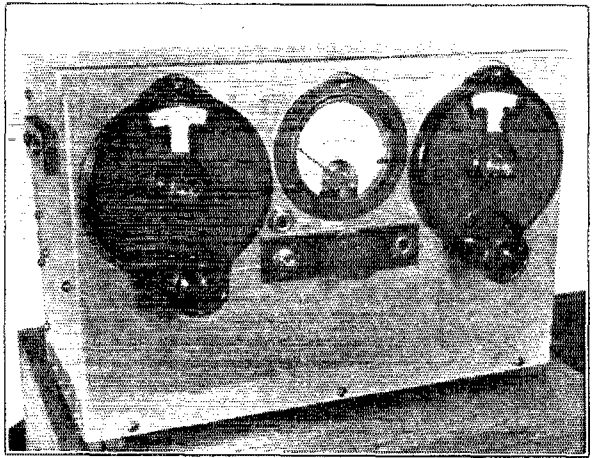

THE COMPLETE SET

*The left hand dial is the tuning control of the receiver and the one to the right operates the frequency meter. The milliammeter is in the plate circuit of the detector tube and indicates resonance between the detector and frequency meter. Regeneration is controlled by means of the filament rheostat located just below the meter. The phones go in the right hand jack and the other mounted on the aluminum panel is for the external "A" battery. The filament switch is below it.*

and plate battery have been properly chosen the main control of regeneration is by varying the detector filament temperature. The Bradleystat shown is in the detector filament circuit only. Of course one may use any other regeneration control as preferred, but W8CMP strongly recommends filament control.

The photos show the condenser coupling the detector plate to the frequency meter as the capacity between a length of No. 14 rubber-covered wire leading from the plate

\*W8CMP, Director, Atlantic Division, A. R. R. L.

and hooked around a short similar wire leading to the frequency meter stator plates. This, of course, makes a fixed capacity best for only a certain band of frequencies. How-

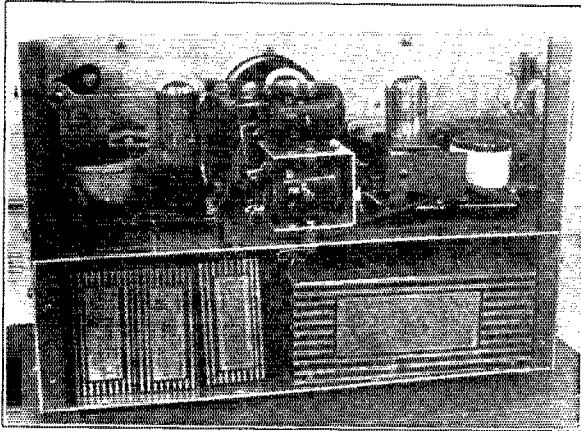

THIS VIEW SHOWS THE GENERAL DISTRIBUTION OF THE BATTERIES AND VARIOUS PIECES OF EQUIPMENT

The tip of the third tube may be seen just behind the audio transformers. In the left hand corner just in front of the frequency meter coil may be seen the two pieces of rubber-covered wire that comprise the coupling condenser to the frequency meter. The two pieces of wire are bound together with a piece of string so that their relative positions do not shift. The antenna coupling coil mounted on a pair of Fahnestock clips may be seen at the extreme right.

ever, this may be compensated for, when measuring frequencies, by suitable adjustment of the filament temperature. A very

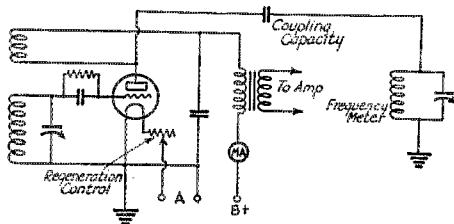

FIGURE 1

The detector may be your present one although it is recommended that you give filament control of regeneration a trial. Any antenna coupling system may be used. The frequency meter is coupled to the plate of the detector tube through a small capacity which may be that between two pieces of wire bound together. The milliammeter in the plate circuit of the detector indicates when the frequency meter is in resonance with the detector and will give a visible indication when the coupling is so loose and the adjustment to resonance made so slowly that no click results in the phones.

small variable capacity is better. Then one may increase said capacity so as to get a definite click at resonance, or decrease the capacity to the smallest amount that will give any change in the milliammeter when

the frequency meter is adjusted. If said capacity is not too large the calibration of the frequency meter is independent of any changes in the receiver, tubes, coils, batteries, or what not. You know very well that if you attempt to calibrate your receiver directly, any one of these items will spoil the results, even when changed a very little.

"Scotch coils" are used, of course, in both receiver and frequency meter. The photo happens to show the frequency meter using a receiver coil with two windings, the tickler coil, however, not being connected to anything.

When using the frequency meter to control regeneration and beat note, if the coupling condenser is small enough the full range of the frequency meter dial may carry the note through its usual range of variations. This makes the control very stable and non-critical. This assumes, of course, that the coils are so selected that resonance occurs somewhere in the frequency meter dial range. Close to resonance the change in beat note pitch, and in regeneration, is at its fastest. However, one has full control over this by varying the coupling condenser.

When resonance is reached the milliammeter reads maximum. The frequency meter then indicates the frequency of the oscillating detector, which, obviously, may be used to find the frequency of incoming signals, or to set the receiver for a scheduled frequency, or simply as an oscillator for calibration purposes. Resonance is also shown, when the receiver is set at zero-beat with an incoming wave, by zero-beat occurring again as the frequency meter is adjusted. This is the most accurate way of setting to resonance. For laboratory purposes this may be done by using any auxiliary oscillator.

Of course, any receiver and frequency meter may be coupled in this manner without any special constructions or arrangements, and you can try out the control before formal construction. It is very probable, though, that if you give this scheme a trial you will find you can't get along without it.

W8CMP will be glad to hear from anyone; criticisms, or requests for further information about this assembly. Better yet, if you ever find it possible to visit State College, put in some time pounding brass and using this receiver at W8CMP.

# Some Suggestions for the Monitor

By George Grammer<sup>3</sup>

FOR the past several months *QST* has been recommending the use of a monitor to all who want to know what kind of signals they are really putting on the air. Since the merits of monitoring are becoming generally recognized, a description of the system as used with various modifications at the writer's station for the past five years may be of interest.

A telephone switch is a convenience but not absolutely necessary, as a double-pole, double-throw, plus a single-pole, single-

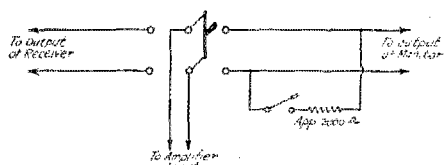

FIG. 1

throw switch will produce the same results. The switching arrangement is that illustrated in Fig. 1. Switching the telephone from the receiver to the monitor has been suggested before, but the S.P.S.T. switch and resistor introduce an additional element of usefulness. This switch is only closed when the telephones are connected to the receiver. The resistance is approximately that of the telephones, and is used in order to avoid a change in plate voltage and the frequency generated by the monitor tube which might occur if the monitor output was merely short-circuited.

The advantage of this arrangement is that the oscillations of the monitor may be picked up in the receiver, and if the monitor is tuned exactly to the transmitted frequency, the exact position of the latter will be shown on the receiver dials. The monitor may be calibrated, and the transmitter frequency determined much more accurately than by an ordinary frequency meter. Another feature which has proved of value is that the transmitter may be tuned exactly to another station or to any point on the receiver dial by setting the receiver, getting zero beat in the monitor, and then tuning the transmitter to the monitor. The transmitted frequency may be set to within a few cycles of that frequency desired, by careful manipulation. Likewise,

a request for a frequency reading may be answered very quickly by adjusting the monitor to zero beat with the received signal, and can be given much more accurately than by the frequency meter click method.

The circuit which has proved most satisfactory at the writer's station is shown in Fig. 2. The monitor is built into the same cabinet as the receiver. A two-stage audio amplifier is used, the first stage being connected permanently to the receiver and the last stage switched from receiver to monitor. The monitor is built for 3,500 kc. and the condenser and coil used are adjusted so that they just cover this band. The monitor is calibrated by the familiar method of using broadcast station harmonics, and is checked frequently to keep it accurate. The receiver uses plug-in coils wound on tube bases. For 7,000-kc. operation, the second harmonic of the monitor is used and for 14,000 kc., the fourth. Only one calibration of the monitor is necessary for all bands, multiplying the fundamental by 2 for 7,000 kc., 4 for 14,000 kc. et cetera. A shield of copper screening completely covers the inside of the cabinet. The use of harmonics in the monitor avoids the necessity for complete shielding of batteries.

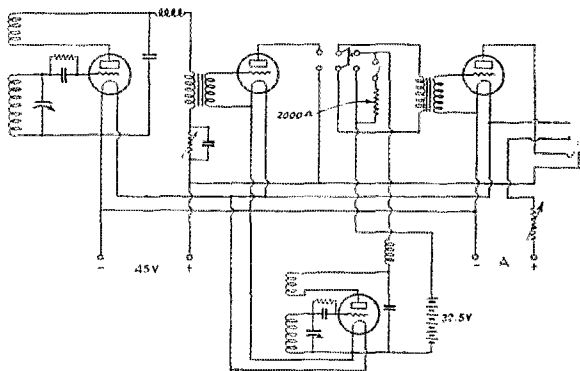

FIG. 2

Separate "B" batteries are almost a necessity and a 22-½ volt unit is used for the monitor. As can be seen from Fig. 2 in ordinary operation, with the double-pole switch to the left and the single-pole switch open, the receiver will be in operation and the plate circuit of the monitor is open, thus conserving "B" current and avoiding the possibility of undesired interference in the receiver from the monitor.

(Continued on Page 48)

<sup>3</sup>W3AIH, 36 Central Ave., Audubon, N. J.

## Now—the Vacuum Tube Ammeter

By L. W. Hatry\*

**A**N ammeter that is good to measure a few microamperes as well as many amperes ought to be a useful doodad. Fortunately, that hard working, patient and versatile little three-lunged audion can be persuaded to such duty.

During some experiments with audion detectors using low plate voltages, some knowledge concerning the static characteristics of the tubes to be used was needed. The particular need was for the grid voltage/plate current curve, the familiar pulled out "S" one, and more particularly to find out about the bottom knee of the curve where the plate current is very low. Yet, all that was had in the way of low current ammeters was a 3 milliampere one and a 10 milliampere one. The problem was to amplify the microamperes in the tube circuit to be measured into milliamperes so that they could be measured with the meters available.

As will be seen in Figure 1, our vacuum tube ammeter is but another application of our old friend the vacuum-tube voltmeter, the most useful instrument. Vt1 is the vacuum tube, the characteristics of which are to be measured and vt2 is the tube to be considered as the vacuum-tube ammeter. The vt ammeter consists of R, vt2, MA, P1, the necessary batteries and a high resistance voltmeter which is connected to the two posts labelled V. Guess voltages will do very well if an ordinary voltmeter is applied to the bias battery and if it is fresh and will not drop under the potentiometer load.

The procedure is simple enough. The "B" voltage to the ammeter tube should be about 90 and the tube can be a 201-A preferably, although any similar or more powerful tube will do—or less powerful if the milliammeter is sensitive enough. It is first necessary to learn something about the bias voltages of the ammeter tube and their effect upon the plate current of vt2. By working near the knee of the Eg/Ip curve of vt2, a very small voltage on the grid can be made to have a large plate current effect. With a tube like the 112, which takes about three times the plate current of the 201-A, considerable plate current change will result with even a high negative bias on the grid and a high negative bias is sometimes important as will become evident.

Vt2 having been calibrated, we are ready to turn on vt1 and get its curve. The way we find the current in the plate circuit of vt1 is to measure the voltage drop across

R by finding its effect upon vt2. If R is 10,000 ohms, for instance, we may apply the usual formula in which the voltage drop is equal to the product of the current through the resistance multiplied by the resistance; or symbolically,

$$V.D. = IR$$

V. D. will be in volts if I is in amperes and R in ohms, as usual. To pass a current of 10 microamperes through R which is 10,000 ohms will require a voltage drop across R of .1 volt. And .1 volt can be made to have a nicely indicable effect upon vt2 and the milliammeter if the potentiometer is adjusted to obtain a favorable bias. In other words, if we measure .1 volt drop across R according to the effect upon vt2 and we know that the resistance of vt2 is 10,000 ohms, we will know that we have 10 microamperes in the plate circuit of vt1 as our formula can be solved for the missing I. Of course, the voltage across R must be subtracted from the "B" battery voltage of vt1, which "B" supply must be variable since a current of 1 milliampere through a re-

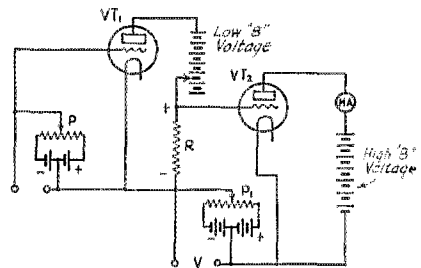

FIGURE 1. THIS IS THE ARRANGEMENT USED TO MEASURE THE LOW PLATE CURRENT OF TUBE 1.

The voltage drop across R is measured by means of the second tube and the current through the resistance calculated from Ohm's Law. In this circuit arrangement, the potential across R tends to run the grid of the measuring tube positive and unless a high negative bias may be obtained, is likely to cause inaccuracies due to a flow of grid current.

sistance of 10,000 ohms will be due to a drop of 10 volts. A potentiometer added to vt1's "B" supply to add as high as 6 or 8 volts with control to the tenth of a volt would be useful or not, according to the accuracy in measurement desired.

It is obvious that if a current of only 10 microamperes will result from as large a voltage drop as .1 volt through the resistor of 10,000 ohms that any grid current drawn by vt2 will be very dangerous to the accuracy of the results. It is, therefore,

\*Hatry & Young, 126 Ann St., Hartford, Conn.

extremely important that the grid of vt2 be highly negative. Especially is this true in Figure 1, the connections of which cause the drop across the resistance to impress

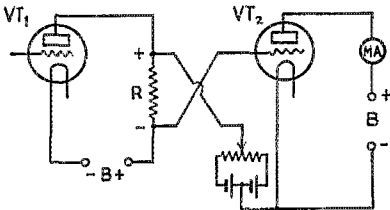

FIGURE 2. IN THIS CASE, THE POTENTIAL ACROSS THE RESISTOR R TENDS TO MAKE THE GRID OF THE MEASURING TUBE MORE NEGATIVE AND OVERCOMES ANY TROUBLE DUE TO GRID CURRENT

a positive voltage on the grid of vt2. The connections to vt2 may be reversed so that a negative bias is created by the drop in R as shown in Figure 2.

Likewise it is obvious that in any circuit carrying current, a useful amount of R can be placed so that measurement of the potential drop across R will tell the current in the circuit by means of a simple calculation. Thus it is possible to measure currents in microampere strength or in ampere strength. Of course, since it is necessary to have a resistance R, there will be cases when it is impossible to use the vt ammeter satisfactorily. But there are many cases where the vt ammeter, providing we can get hold of known resistors, will be very useful and especially is it true in the laboratory where always is the desired instrument the very one not to hand.

Where the current value in R is large and grid current in vt2 will not upset anything, some very useful stunts can be worked up by adjusting vt2 to the upper or positive knee of the curve and causing a relatively small negative bias to produce a relatively large change in plate current, large enough, for instance, to release relays, etcetera. The reverse can be worked and relay contacts closed, and so on.

Whether you call this a vt ammeter or an application of the vt voltmeter doesn't matter a great deal: The thing has many uses just the same.

Oh yes, by making the current in vt1 large enough to fit the milliammeter on hand we can solve the formula for R and measure all sorts of resistances with fair accuracy and without a bridge, by getting the current through and the voltage drop across the resistor.

## The Midwest Division Convention

WHOEVER invented the word "WOW" gave us a very descriptive expression. The Kansas Section convention held at Topeka, on October 12th and 13th, under the auspices of the Kaw Valley Radio Club was a WOW. With a good attendance, good speakers and good food, it was enough to satisfy the most fastidious.

We had a pleasant surprise in the attendance of Dr. E. C. Woodruff, of State College, Penn., the director of the Atlantic Division and owner and operator of W8CMP. He had his famous wavemeter and receiver and gave us one of the best talks of the convention. Porter Quinby, our Director, brought over his tube base coils and showed us how easy it is to make a good traffic tuner. Norvel Douglas, W9EHT, one of our best experimenters, told us all about television. Then came W9BHR, who gave us the dope on his new circuit—the one tube, MO-PA. A good talk was also given by W9CET on screen grid receivers. All in all, a lot of worth-while technical information was given during the two days.

The owners of station WIBW, through Mr. Harrell, Chief Engineer, extended courtesies that will long be remembered by inviting the whole "gang" to dinner Friday night at the Hotel Jayhawk; and it was some "feed." Our thanks for the fine hospitality.

The Radio Division showed its coöperation by having Inspectors George Turner and Wm. McDonell present to give examinations. Some thirty-one sat down at the Federal Building for the ordeal and it is our understanding that practically all passed. Good work fellows! It is not so hard after all, if you don't lose your nerve. The entertainment features were not forgotten and 21 prizes were distributed to those who had won in the several contests that took place during the convention. The gang had been requested to bring anything in radio apparatus they wished to dispose of. You should have seen the bidding during the auction sale and a lot of good apparatus changed hands.

Last and not least, came the Banquet, Saturday evening, with Director Quinby as the *scorchmaster* and a noble job he did—he burned up every one from W8CMP to W9CV.

As the saying goes, a good time was had by all and every one went home tired but happy with fond recollections and new friends made.

—W9CV

## Experimenters' Section Report

IT is a fortunate thing that radio communication is but a small branch of electrical engineering for this allows the radio experimenter to occasionally wander off into (what may be to him) foreign territory. The effect of such wanderings is practically always helpful because it stimulates interest in other problems, encourages mental activity along lines that would not ordinarily be pursued and broadens one's views upon engineering as a whole. Problems that do not directly concern the transmission and reception of radio signals should, therefore, not be scorned by the experimenters but should, rather, be welcomed as a form of technical diversion.

### A SIMPLE METHOD OF RECORDING CLOCK BEATS WITHOUT A MECHANICAL CONTACTOR

An experimenter, D. F. Brocchi, 431 Thackery Place, Seattle, Wash., writes in concerning a problem of taking off beat impulses from a clock to operate a chronograph to be used in some non-radio work in which he is interested. The following gives his account of the problem and his partial solution of it.

"An electrical connection between the clock and chronograph by a mechanical contact is likely to reduce the accuracy of the time rate of the clock, unless this is equipped with a 'free elasticity' or 'gravity' escapement. Unfortunately this class of clocks involves the expenditure of a small fortune, and in the case under consideration, a jeweler's regulator with 'dead beat' escapement was the best that could be afforded.

"The original arrangement consisted of a gear wheel, mounted on the staff of the escape wheel and with one tooth cut off. At every other beat it would raise the end of a spring, thereby breaking the chronograph circuit, and at intermediate beats it would release the spring, allowing it to close the circuit again. The missing tooth was for the purpose of indicating the beginning of each minute on the chronograph paper.

"By such arrangement the braking action on the escape wheel was reduced to half of what it would have been, had the circuit been made to open and close at each beat. Furthermore, the spring was made as weak as consistent with the pressure required for a satisfactory contact.

"In spite of the foregoing precautions, when the clock was compared with radio time signals from U. S. naval stations after the installation of the device, the time rate was found to be impaired.

"In order to eliminate the mechanical

contact, the use of a photo-electric cell was considered, this system having been successfully used at the Bureau of Standards. Investigation disclosed this system to be more complicated, cumbersome, critical and expensive, than would be practical under the circumstances, and research was continued in other directions with satisfactory results in the adoption of a microphone re-

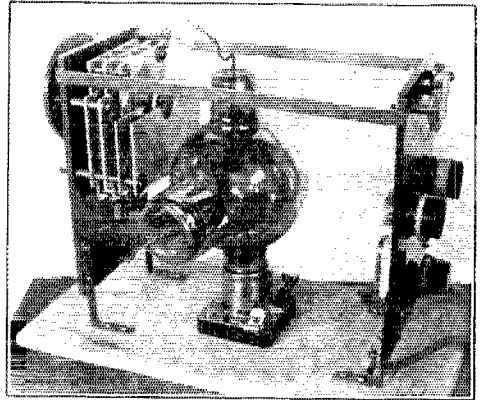

THE ABOVE PHOTO SHOWS A VIEW OF THE 28-MEGACYCLE TRANSMITTER IN OPERATION AT WSCMP

The tuning condenser is mounted on the panel at the left and consists of eight plates, only one of which is variable. This allows the use of a high tank capacity as well as accurate adjustment to a given frequency. The bands holding the two panels together comprise the inductance of the circuit and the tube-base coils mounted on the panel are r.f. chokes. A variable grid leak appears beneath them. The filament supply is connected directly to the socket in which the tube is mounted and the plate supply leads are connected to terminals at the bottom of panel on the right.

lay circuit. This is illustrated in the sketch and is mostly self explanatory.

"A single-button microphone is fastened to the frame of the clock and the jar of the clock beats (not their sound) operates the microphone which is stripped of mouthpiece and other trimmings leaving only the button itself.

"The variations in microphone current cause a voltage to be applied to the grid of the tube which is biased so as to operate on the lower bend of the grid voltage plate curve. Thus, positive impulses to the grid cause a larger change in plate current than do negative impulses and the plate current will increase when a signal is impressed upon the grid. This actuates the relay in the plate circuit and the by-pass condenser keeps most of the a.c. out of the relay circuit which might be caused to chatter if it were to carry both the a.c. and the d.c.



"So far, things are all right but when it is desired to obtain an indication on the chronogram of the beginning of each minute, trouble arises. The most successful solution arrived at so far, has been the use of a contact spring and gear wheel which has all but one tooth cut off. This tooth causes the plate circuit to be opened once each minute.

"The apparatus has not yet been in operation with the clock for which it is intended, owing to a temporary absence from the observatory enforced by the necessity of making a living. It has been tried, however, on a pendulum clock (plate lead switch omitted) and found to function so satisfactorily that the relay spring had to be stretched to a tension of 2½ ounces.

"It must be admitted, after all, that this does not solve the problem entirely, failing, as it does, to provide non mechanical means for indicating the beginning of the minutes on the chronograph paper.

"True, the amount of interference with the time rate produced by a single tooth would hardly be worth considering, very probably it would be less than that from

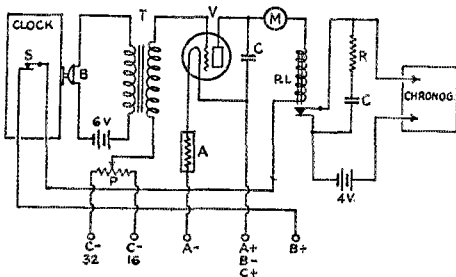

FIG. 1

changes of temperature, in spite of the lamp and thermostat inside the case. But on account of local conditions, the plate lead to the clock and back would have to be of considerable length which is undesirable.

"It is hoped that some readers might be clever enough to dope out a scheme, whereby the once-per-minute interruption can be effected without altering the impulse to the pendulum at any time so that no error in the time rate will be caused."

TELEPHONE RINGER INTERFERENCE

D. I. Gue, VE4FF, of Alliance, Alberta, Canada, has been troubled with interference from the telephone ringing machines at the local telephone exchange. He found that when he inserted his frequency meter in the circuit tuned between 8,500 and 10,000 kc. the interference was cleared up satisfactorily.

He then made up a pair of coils to

resonate at about 9,700 kc. by winding 52 turns of No. 20 d.c.c. wire on a piece of paraffined broom handle ⅜-inch in diameter. The ends of the winding are passed under binding screws and about a foot of wire is left over so that the two leads may be twisted together to form an adjustable condenser with which to make final tuning adjustments. The capacity between these leads can be varied sufficiently to allow the frequency to be varied from about 6,000 to 10,000 kc. A surprisingly small difference in the separation of the wires has a marked effect upon the frequency.

When these coils were installed in the output leads of the ringer, the interference was reduced to about 15 percent of its original value and in this particular case there was no need for further reduction because the interference was then at about the constant noise level. Unless conditions were very clear, signals weaker than the interference would not be heard.

It is realized that this is not a complete answer to the problem but is presented in hopes that it will suggest to those who are having trouble of this nature the thought of employing tuned trap circuits in the output leads of the ringer. The particular frequency at which the interference from this machine was peaked will probably not be a characteristic of all other machines and it may be necessary to build you chokes to resonate at a frequency differing widely from that mentioned above.

AUDIO OSCILLATOR

John L. Reinartz brings to our attention once more the use of the neon tube as an audio frequency oscillator. He writes as follows:

"The small neon tube has many uses in the radio room due to its ability to glow

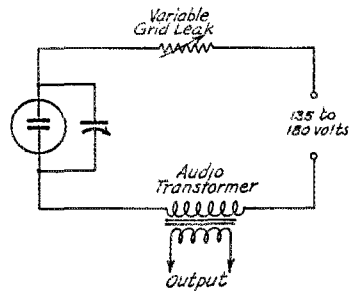

FIG. 2

at very small current values and, next to the radio frequency type ammeter, its greatest use is in the frequency meter as an indicator.

"Those of you who have a frequency meter using a neon tube as an indicator can now add the usefulness of that meter by

making of it an audio frequency oscillator which lends itself to many useful purposes.

"When a condenser is connected across a battery, a definite time is required in which to fully charge it. If a resistance is placed in series with this capacity, the time required will be increased, becoming longer as the resistance value is increased.

"If a neon tube is connected across the condenser, it will not glow until a certain voltage (depending upon the characteristics of that particular tube) is exceeded. It will continue to glow until the voltage is reduced below a certain value which is usually quite a bit below the igniting voltage.

"When the voltage is applied across the circuit in Figure 2, a current will flow through the resistor (the primary of the audio transformer may be considered as additional resistance) and charge the condenser. When the charge reaches a value where the voltage across the condenser is sufficient to break down the resistance of the neon tube, the condenser will discharge through the tube until its voltage drops below that value which will maintain the glow. The battery cannot keep the tube glowing because a large current flows through the tube and if this were to be supplied by the battery, a higher voltage would be necessary in order that the voltage drop across the resistance would not reduce the voltage across the tube below the extinction value. The result is that when the tube glows, the voltage across it drops rapidly and soon reaches a value too low to maintain the glow and it is extinguished. Upon extinction, the current drain upon the condenser ceases and the charging portion of the cycle is repeated.

"The frequency at which this operation takes place depends upon four things. These are:

1. The difference between the voltage at which the neon tube ignites and that at which it is extinguished.
2. The capacity across the neon tube.
3. The resistance in the battery lead to the tube and condenser.
4. The applied potential.

"The first of these is a characteristic of the neon tube and is not usually under the control of the experimenter. The capacity across the tube may be quite small and the condenser in your frequency meter will probably be sufficient. The resistance in the battery lead should be of about three or five megohms and preferably variable. The potential to be applied should be that at which the neon tube ignites when it is connected directly across the battery. This will vary with the individual tube and will usually be somewhere between 135 and 180 volts.

"In practice, the frequency is varied by changing either the resistance or the ca-

capacity and if the neon tube and condenser in the frequency meter is being used, it will be simpler to use the condenser. The range over which the oscillator is varied may be conveniently controlled by the condenser and the relative position of this range in the frequency spectrum determined by varying the resistance.

"The output of the oscillator is taken off across the secondary terminals of the audio transformer which may have any convenient ratio.

"The oscillator may be used as the source of alternating current for simple bridge measurements although the harmonic content is rather high when a critical balance is desired. A simple bridge for the measurement of capacity is shown in Figure 3. When the two resistance arms of the bridge are equal, the two capacities will be equal at that adjustment giving no sound in the phones. The balance of the resistors may be checked by reversing the two condensers and rebalancing the bridge. If the reading of the variable condenser is the same regardless of which arm of the bridge it is in, the two resistors are of the same value.

"There are many other uses to which the oscillator may be put. They will not be given here inasmuch as the average experimenter will adapt it to his own needs and conditions."

#### SAVING FILTER CONDENSERS

A suggestion made by Mr. Cahill of Cruft Laboratory concerning filter condensers has been passed to us by Harris Fahnestock, Jr., W1ZI-W1BBO.

The idea is to place a low resistance of two or three ohms in series with the filter

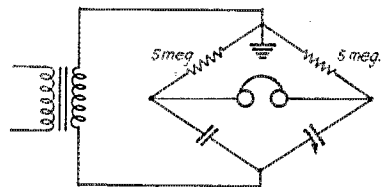

FIG. 3

condenser in order to reduce the effects of dangerous transients that many times result in condenser breakdown. The effect upon the efficiency of the filter should be slight unless the condensers are passing an undue amount of current.

#### CIRCUIT DRAWINGS

Many experimenters have an earnest desire to keep notes in an orderly fashion but have extreme difficulty with the circuit diagrams. The skill to draw clear, well balanced neat drawings is not everybody's and the clipping and pasting of diagrams taken from magazines, etc., unless very carefully done will result in a crude and variegated conglomeration of notes. A suggestion to

overcome this condition is offered by W. T. Clayton, Jr., of Magnolia, Miss.

The general idea may be obtained from Figure 4. Light guide lines are ruled across the paper with pencil and serve to keep the drawing from staggering either up or down the sheet. The distance between lines A and B, for instance, should be equal to the transformer and coil symbols as they are commonly drawn. Other lines should be drawn across the page for the filament, plate and bias battery circuit busses.

The use of guide lines alone will be of great assistance in most cases and for the man who is desirous of making drawings that are still neater, some additional suggestions may be adopted. In this case, the notebook paper should be somewhat transparent and the guide lines drawn as suggested above. In addition, a page of symbols is prepared and each symbol is accurately drawn in heavy ink lines so that they may be seen through the note book sheets. The drawing then consists of placing that symbol to be drawn, beneath the note book page and tracing it upon the note page. This will take much more time but will result in a diagram in which all the parts are in proper proportion and, due to the guide lines, are evenly aligned.

Some space should be left below the diagram so that the constants of the circuit may be indicated. This important factor is often overlooked and the results of ex-

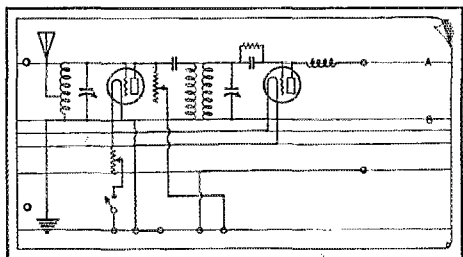

FIG. 4

periments made doubtful because at a later date one cannot remember whether the capacity of the condenser was 250  $\mu$ fds. or 500  $\mu$ fds., etc.

REFLECTORS

At the present time many are considering the use of reflecting systems for transmission in the 28- and 56- megacycle bands. A few points concerning the theory of reflectors which have been contributed by Harry A. Bremer, of the Hudson City Radio Club, Inc. of Jersey City, N. J., may not be amiss. This information was presented in a short paper read before that club.

A vertical, half-wave antenna will radiate energy equally well in all directions and if a similar antenna is located parallel

to it and a half wave length from it, it will absorb some of this energy and reradiate it. Because the second antenna is a half wave from the first antenna, its reradiation will be in such a phase relation that it will aid transmission in the direction of an arrow pointing from the reflector to the radiator.

Such an arrangement will not concentrate the radiation in a beam and if this type of transmission is desired it will be necessary to make a more complete reflecting system. If a number of reflectors arranged in the form of a parabola with the radiator at its focal axis is employed, the radiation will take the form of a beam, its sharpness and concentration being dependent upon the completeness of the reflecting system.

Figure 5 shows the arrangement of a parabolic reflector of seven wires. The antenna is located at the focal axis of the system. A fundamental consideration of a parabolic reflector is that the distance from the antenna at the focal axis to a reflector wire plus the distance from that reflector to the aperture will be the same for all reflectors. This is shown by the dotted lines in the figure. The length of any of these paths will be equal to twice the distance between the antenna and the wire A.

From this it is seen that the energy radiated by the antenna is reradiated by the reflectors in such a phase relation as to cause reinforcement of the wave in the direction indicated by the arrows. Radiation in other directions is cancelled out due to the difference in the phase relations of the reradiations from the reflectors.

The sharpness of the beam may be increased by extending the parabola as is shown by the dashed line in the figure. This will reduce the amount of leakage radiation to the sides.

The use of reflectors of this type is by no means new but is probably one of the oldest things in radio. In 1896 Marconi transmitted and received signals over a

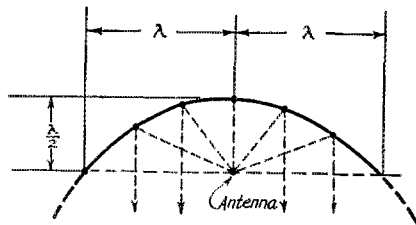

FIG. 5

distance of 1 1/4 miles by means of a beam system employing high frequencies. Hertz proved in his experiments that short electrical waves obey the same laws of reflection, refraction, diffraction and propagation as do light waves.—H. P. W.

# Calls Heard



*Alan G. Brown, 8 Mangarra Road, Canterbury, E7, Victoria, Australia*

wibux wicmf wicmp wlmx wliq w2aer w2aly w2ao  
w2avb w2azk w2zqd w2ne w2ws w3az 3ekl 3lw 3xk  
4aaq 4aah 4adf 4ib 4ix 4qb 4rp 4tk 4zze w5aby w5aek  
w5aep w5afb w5afg w5afx w5agc w5age w5akx w5amo  
w5anx w5are w5ark w5asm w5awd w5ayh w5ayo  
w5ayt w5abd w5abz w5beb w5bdh w5bdx w5beb w5hd  
w5kl w5lv w5oa w5qj w5ql w5rd w6ael w6ajc w6am  
w6ami w6amm w6aos w6aok w6aai w6aaw w6awa  
w6awy w6byp w6bpm w6bjf w6bws w6bzy w6bzw w6cbw  
w6ccu w6ccv w6ccm w6ccq w6cha w6chy w6cj w6civ  
w6ckv w6erd w6etx w6cuh w6cut w6cvj w6cxi w6czk  
w6czm w6dds w6dfm w6dgv w6dhs w6die w6dit w6dkv  
w6dmm w6dns w6dog w6dow w6drb w6drr w6dsi  
w6dtd w6dtl w6dvl w6dvt w6dzj w6eap w6ebm w6ec  
w6ech w6eck w6eeb w6eco w6efr w6fa w6ht w6kj  
w6jt w6wg w6zq w7aax w7abb w7adi w7aeg w7ab  
w7akm w7amo w7ane w7dm w7fh w7fq w7lm w7lz  
w7mi w7mm w7sk w7uo w7ve w7ab w8ajv w8ank  
w8bau w8bbi w8bhi w8bpl w8cft w8dkw w8do w8dpo  
w8zz w8kc w8lj w8sx w8wo w8zg w9aex w9afu  
w9ain w9ama w9ams w9baz w9bca w9ben w9bir  
w9bke w9blv w9bn w9bnf w9boa w9bqk w9ccu w9cde  
w9chd w9cid w9cia w9cup w9esx w9evr w9cwh w9dft  
w9dfy w9drd w9drn w9dyl w9eap w9edw w9epa w9ef  
w9efj w9ejo w9eme w9eur w9wmm w9fdi w9fgp w9fhy  
w9fxr w9gq w9gv w9mm w9pu w9pw w9sk w9ha  
w9faf w9bgv w9ef w9aw na-7ann nq-2co nq-5by  
oh-4ar oh-4hn oh-4co oh-4ft oh-4rc oh-4rs ef-8axq  
ef-8ca ef-8eo ef-8fr ef-8gd ef-8gj ef-8im ef-8ix ef-8orm  
ef-8yb ee-2un ee-2yd ek-4aq ek-4ka ek-4ai ek-4nah  
ek-4at ei-1fr ei-1go ei-1no ei-1po ei-1bp ep-1bv ep-1cf  
ep-1ce ep-1ck ep-3ap ag-rbl4 aj-2by aj-2cy aj-4zz  
aj-7cb aj-7mf aj-ixix ac-1bs ac-2mo ac-3ma ac-7sw  
ac-8ag ac-8ri ac-8ra ac-wuq ai-2kw ai-2bj fo-a3y  
fo-4ae fo-4ra fb-8aa fm-ocup fu-8hpy suz sa-de3  
sa-dt2 sc-2ab op-1ad op-1ae op-1cm op-1cw op-1hr  
op-1mc op-1rc op-9pd od-1jr oh-6akg oh-6avl oh-6bq  
oh-6ch oh-6dq oh-6ekx oa-8xt.

*G. B. Ragless, South Road P. O., St. Marys, South Australia*

30-40 meters

wibux wicmx wlgw w2abe w3qe w4cj w4acz w4ib  
w4ob w4rn w4si w4to w5aws w5aqe w5bj w6ael w6aaj  
w6aaj w6awe w6awv w6agr w6am w6aee w6awp w6anu  
w6akm w6asj w6bkw w6buu w6bf w6vv w6vs w6ben  
w6chq w6ci w6cub w6cyr w6dha w6dgt w6dbo w6dfq  
w6dms w6dky w6dtp w6dkx w6dkb w6dmg w6dye  
w6drd w6eg w6ta w6rj w6zgg w7aax w7acy w7ac  
w7ab w7als w7fh w7hm w7mx w7wc w7ts w7tz  
w7drs w7dpo w7sp w7cdw w7cys w7dr w7lm w7pb  
w7pm w7xl w7eco nn-1nic nn-7nic ea-2aa ac-2ab  
ac-2al ac-2ek ac-2ff ac-3cl ac-3fl ac-3ri ac-3tc ac-9aa  
ai-2kt aj-1sm aj-1sk ai-4bk aj-4bd aj-4dk ai-4zz su-1oa  
sh-3ra kber k6fo k6dgp k6dd k6dog k6dvz k6dki  
op-1cm op-1hr op-9pb eb-4au eb-4ft ef-8fc ef-8ct  
ef-8fo g2od g5yx.

20 meters

w1abt w1arc w1bux w1gy w1ry w2arb w2bfq w2bbg  
w2tp w3sh w3km w4pd w4rr w5afx w5agq w5aot  
w5aq w5au w5rg w6q w6m w6aov w6azs w6bax  
w6bf w6cei w6cqh w6cej w6cub w6cve w6dfv w6dfe  
w6dlw w6drb w6ej w6ze w7aes w7afu w7ahx w8adg  
w8avp w8baz w8ehd w8ecw w8eed w8dod w8dtn w8diy  
w8ayp w9adn w9avv w9cf w9ez w9dza w9dzn w9pu  
velco aj-law eb-4au ef-8cp ef-8fr ef-8hp ef-8orm  
ef-8pam g2cx g2od g2nh g5by g5hs g6ma g6ml g6mq  
g5uw g6rw g6vp k6alm k6avl.

*oa-7CH, C. Harrison, Bellerive, Tasmania*

eb-4ac eb-4ar eb-4au eb-4bc eb-4fp eb-4ft eb-4hp  
eb-4ro eb-4wx ac-aa2 ed-7fj ed-7fr ee-ear10 ee-ear65  
ef-8eo ef-8xo ef-8et ef-8ia ef-8fd ef-8zb ef-8bf ef-8hz  
ef-8lb ef-8op ef-8jf ef-8fr ef-8cl ef-8fc ef-8ix ef-8ro  
ef-8axq ef-8dmf ef-8raf ef-8tht ef-8fzx ef-8hip ef-7ynb  
ef-8orm ef-8vvd ef-8grg ef-8pam ef-8pro ef-8btr ef-8est  
ef-8wb g2bm g2nh g2zv g2zc g5iv g5lf g5ha g5yx  
g5by g6mq g6yv g6td g6wi g6ut g6mu g6vl ei-lay  
ei-lbs ei-lch ei-ldy ei-lfp ei-lmg ei-lno ei-llt ek-2ud  
ek-4yo ek-4vr ek-4yt ek-4ui ei-laix em-5mm ep-lae  
ep-1ag ep-1bx ep-3am ea-1eo ea-2maa es-2mm ew-lhb  
ac-1ax ac-1el ac-2ek ac-2ff ac-8hb ac-8rj ac-8cl ac-9aa  
ac-2bk af-1b ag-464rk ai-2au ai-2bg ai-2kt ai-2kw  
ai-2kx ai-2rxp ai-7vx aj-1aw aj-1gs aj-1sk aj-4zz  
aj-ikzb am-1ab am-3ab ag-lhf ag-1km ag-1mdz ag-bd2  
fe-egex fm-8st oe-8xz od-1jr od-2aj od-4as oo-1aj  
oo-bam oo-drk op-1bj op-1cw op-1hr op-1mc op-1pw  
k7aeb k7als k7jr k7ly ve2ca ve4fv ve6az ve6bn ve6co  
ve9bz nm-1z k4sa nq-5by ns-1fmm nn-1nic ac-2bm  
su-1cg xep-1ma xep-1mp xem-3fv xne-voq xnu-kv3  
xnu-md.

*W. A. Bousfield, York St., Bellerive, Tasmania*

20 meters

wiaqd wibjd wibs wibvy wicjc w2api w2bac  
w2hev w2bvq w2fk w3aqi w4aq w5aek w5aot w5at  
w5bat w5bbc w5tt w5wz w6dhs w6qy w7afm w7nr  
w8ced w8dtn w9adn w9axf w9bqy w9ef w9emr w9ez  
w9fbw w9krd ea-jh eb-4rk ef-8gdb ef-8orm ef-8ycc  
cg-2hm c2cx g2od g2zv g2nh g5by g5bz g5mq g5ms  
g5wk g5yx g5bb g5by g6hp g6oo g6qb g6vp g6wy  
k6alz k6hoe k6cij ac-1ah.

40 meters

w1fs w2cxl w3apn w3bqv w4fe w4tk w5adz w5afx  
w5ark w5bi w5mx w6add w6avp w6aoo w6asj w6ard  
w6bgv w6bm w6bx w6cqv w6cpq w6cuq w6cux w6cyc  
w6dev w6dmm w6dow w6djc w6dky w6fa w7ts w7vx  
w8ben w8br w8cnu w8dcm w8ewm w8tn w8ub w8ben  
w9bqc w9cph w9cia w9cya w9gv w9mm w9oq w9mm  
ac-2mo ac-9aa eb-4au eb-4bn eb-4ca eb-4f eb-4ft  
eb-4rk ef-7r eb-v3 ef-8axq ef-8ost ef-8fd ef-8ic ef-8if  
ef-8ku ef-8gdb ef-8orm ef-8rkt ef-8aan ef-8vvd ef-8wb  
ef-1m g2od ep-lae ep-1bl ep-3am ew-1hb fm-8dot  
fm-ain fo-8hpy nn-9a od-1jr od-4as k6akg k6qh k6ch  
k6djf k6dgp op-1ad op-1cm op-1hm op-1hr op-1pw  
op-1rc op-9pb op-9pl.

*VH2CK, Gordon Weynton, 1 Harcourt Flats, Brierley St., Cremorne, Sydney, Australia*

w1abz w1bk w1bs w1bux w1bx w1cz w1cz w1fs  
w1mc w1om w1xd w2afe w2apf w2bgo w2bpo w2emg  
w3fa w3ns w3pa w3wa w2wi w2wr w2ws w2wk  
w3hl w3ne w3fx w3lh w6aie w6afs w6am w6aov  
w6apd w6avl w6bkg w6bp w6bq w6cef w6chl w6clj  
w6cpo w6ctx w6cwo w6cyr w6dcq w6dey w6dhs w6dkv  
w6dkx w6dqe w6dud w6dyj w6dzk w6ebn w6ec w6edp  
w6kq w6nb w6no w6yu w7agb w7ar w7aub w7bu  
w7iz w7jh w7mm w7tn w7vl w7wbk w7hda w7hck  
w8bk w8br w8cxw w8dgb w8dpo w8ea w8xt w9abv  
w9am w9bb w9caf w9cos w9cup w9dbw w9hd w9cz  
w9ede w9ef.

*Sydney A. Pegrum, % Barclay's Bank, Nairobi, Kenya Colony, Africa*

w1by w1ry w1fs wicmf wibux eb-4au eb-4rs ek-4au  
ef-8pro ef-8tst ef-8es ef-8rm ef-8if g5hs g6qb w6ut  
(Continued on Page 51)

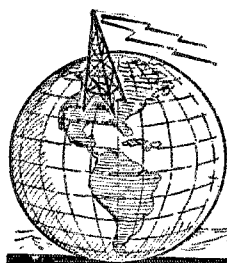

# I. A. R. U. NEWS

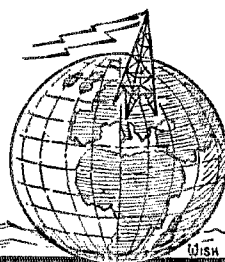

Conducted by A. L. Budlong

## NEW CONSTITUTION ADOPTED

On October 30, 1928, by an official vote of the existing National Sections of the I. A. R. U., the Union adopted a new Constitution, and thereby entered a new era as a Union of representative national amateur societies in the various countries of the world. Individual membership is no longer possible; the Union members are now amateur organizations, one from each member country.

The present membership of the Union under the new Constitution is made up of those National Sections in existence at the time of adoption of the new document. The Secretary begs to advise societies in other countries that he will now be pleased to receive applications for membership into the Union from other representative amateur societies throughout the world.

The new Constitution follows in full:

*Amended Constitution of the International Amateur Radio Union.....Adopted Oct. 30, 1928.....*

### ARTICLE I—NAME AND OBJECTS

1. The name of this organization is The International Amateur Radio Union, hereinafter called the Union.

2. Its objects shall be the promotion and co-ordination of two-way radio communication between the amateurs of the various countries of the world; the effecting of co-operative agreements between the national amateur radio societies of the various countries of the world on matters of common welfare; the advancement of the radio art; the representation of two-way amateur radio communication interests in international communication conferences; the encouragement of international fraternallam; and the promotion of such additional activities as may be allied thereto.

### ARTICLE II—MEMBERSHIP

1. The membership of the Union shall consist of the national amateur radio societies which, on the date of the adoption of these provisions, are recognized as sections of the Union under its previous Constitution, and any additional national amateur radio societies which subsequently may be admitted to membership as provided below.

2. A national amateur radio society is defined as a non-commercial association of radio amateurs, devoted substantially to the interests of two-way amateur communication and experimentation, the influence and recognition of which substantially cover the country or separate colony in which it is located. There shall be but one member of the Union from each country or separate colony.

3. Any such national society desiring to become a member of the Union shall make application by letter

to the Headquarters of the Union. The application shall be accompanied by a copy of the constitution of the applicant society and any other data which in the opinion of the applicant society would be useful to the Headquarters in establishing the eligibility of the applicant society and its desirability as a member. The Headquarters may conduct such further investigation as may be necessary to determine the eligibility of the applicant. The Headquarters shall thereupon list the application in the next succeeding Calendar published, together with sufficient data and comment to enable the members to vote intelligently upon the question of admission. The affirmative vote of two-thirds of the members shall admit the applicant society to membership, whereupon the Headquarters shall so inform it.

4. A member society may resign its membership in the Union upon ninety days' notice in writing to the Headquarters. At the conclusion of that period, if it has no indebtedness to the Union the resignation shall be accepted by the Headquarters, and announcement to this effect made in the next Calendar.

5. There shall be no entrance charge or dues for membership.

6. Member societies shall be bound to support to the full extent of their ability the interests of amateur radio communication, and failure to do so shall be grounds for the termination of membership in the Union. Upon the written request of three or more members that, for cause therein stated, a member of the Union be expelled, the Headquarters shall consider the matter and, if there appears to be sufficient reason, shall advise the accused society of the charges against it. The accused society shall then have the right to present a written defense, which shall be filed with the Headquarters within ninety days. The Headquarters shall then publish both the complaint and the defense in the next subsequent Calendar and submit the question to vote of the membership, and if in the opinion of two-thirds of the members of the Union a satisfactory proof of the undesirability of the accused society has been established, and it has not in the meantime tendered its resignation, it shall be dropped from membership.

### ARTICLE III—HEADQUARTERS AND OFFICERS

1. The Headquarters of the Union, hereinafter called the Headquarters, shall be located at the headquarters of a member society chosen for this post by vote of the membership. The service of a member society as the Headquarters shall be without definite term and shall endure until the member so serving shall resign the appointment or shall be succeeded by another member by action of the membership. The society so serving shall in any event continue to function as the Headquarters until its successor as such has been determined and has accepted the appointment. The member society chosen to act as the Headquarters shall, during such term, finance the normal expenses of operating the Headquarters from its own funds; but it shall be under no obligation to expend its monies on behalf of the Union for other than the normal operating expenses of the Headquarters as contemplated in this Constitution.

(Continued on Page 64)

# Correspondence

The Publishers of QST assume no responsibility for statements made herein by correspondents.



## More About W2UO

9441 Alstyne Ave.,  
Elmhurst, L. I., N. Y.

Editor, QST:

I would like to say just a few words about the *New York Times* station 2UO. Lately I have been hearing a lot of talk about their doing commercial work with an amateur license and working in the amateur band. I have visited and also operated 2UO myself and have a fair idea of conditions. I cannot see how they are using the amateur bands commercially. Friends and relatives of men on expeditions with which 2UO has kept schedules have depended on that station for contact with them. There is no law or rule violated as far as I know if the *Times* uses a few news items received through contact with these expeditions etc. Once a day a full press report is sent as a "QST". Several hundred vessels having short-wave receivers on board have reported that they copy this daily. Listen on the forty-meter band at 1 a.m. and see for yourself. I have also heard several remarks about 2UO not working hams. There is a good reason for that. The operators (all excellent men) have other duties to perform. They are not paid for the purpose of amateur operating.

Some fellows think because they fail to raise 2UO that it is due to the fact that he has passed him up. Not by all means. Just listen around the band and count the number of stations answering 2UO's CQ!

Three cheers for 2UO including Mr. Murphy and the rest!

R. E. Study, 2AGU

AMERICAN RADIO RELAY LEAGUE,  
HARTFORD, CONN.

Dear Mr. Study:

I am sorry that I cannot agree with much that you say in your letter of September 18th about 2UO.

You yourself say that this station does not have much time for amateur work. You bet they don't! They are, as you say, too busy working for the *New York Times*. The point, OM, is that an amateur station is defined as one owned by an amateur, that is, by an individual interested in the pursuit of the art and without pecuniary interest. The *New York Times* does not op-

erate its station in the pursuit of the art, but obviously and admittedly it does so for the good of the *New York Times*, which is a business concern. We therefore hold that the *New York Times* is not conceivably entitled to an amateur license. You say that you do not believe any law or rule is violated by this station. I hold that their very existence violates the fundamental regulation that amateur licenses will be issued only to amateurs who are interested in the pursuit of the art. Amateur stations are also forbidden by regulations to broadcast news for the information of the public, and yet the *New York Times* does this daily.

I want to make it very clear that I have no quarrel with the existence of this station. I believe that the *New York Times* is entitled to have a radio station and to use the same in the conduct of their business. I believe that they should be permitted to do exactly the things that they are doing. But I insist that their station is not an amateur station, that it should not have an amateur call, and that it should not be permitted to operate on the very precious frequencies which are reserved exclusively for amateurs. If this station gets a limited commercial license, with a commercial call, and moves its frequency a few kilocycles so that it is out of the amateur bands, we shall be entirely satisfied. Until that time we cannot be, and it seems to me that you as a licensed amateur should have exactly the same views.

K. B. Warner, Secretary-Editor

(Editor's Note: After the receipt of the above letter, Mr. Study made another visit to the *Times'* station and discovered that it was much more of a commercial station than he thought. He thereupon wrote us the following letter.)

Editor, QST:

I received your letter in answer to my statement regarding 2UO. Since receiving it I have given the situation a great deal of thought, argument and some investigation. I will have to admit I am inclined to agree with you now. When I was well acquainted with 2UO it was not as it is now. I see now that the *Times* has used our bands for a purpose that other bands are provided for. When I used to visit this station (which has not been very recently) I could not see anything wrong in their op-

**THE  
NEW  
5000 HOUR  
ELKON  
METALLIC RECTIFIER  
FOR  
"B" ELIMINATORS**

At last a dry high-voltage rectifier!  
 All of the advantages of a tube—none  
 of its frailties—much longer life—  
 more efficient—smoother power—no  
 noise—now as perfect a rectifier for the  
 "B" end as the Elkon "A" Rectifier—  
 standard with "A" Eliminator manu-  
 facturers. And the Elkon Rectifiers are  
 Self-Healing—line surges or accidental  
 overloads are automatically taken care of  
 —no permanent injury is done. The Elkon  
 EBH replaces BH type tubes in "B" Elim-  
 inators. Simply take out the fragile 1000  
 hour tube and plug in the husky Elkon  
 EBH 5000 hour Rectifier. Same charac-  
 teristics, but what an improvement.  
 Use the Elkon EBH Rectifier! Eliminate  
 all uncertainty of life, of successful  
 operation. Build your own new "B"  
 Eliminator or convert the one you have  
 to up-to-the-minute radio efficiency.

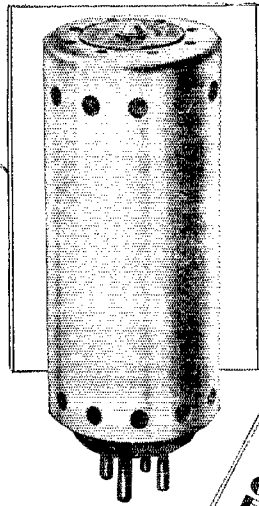

**ASK  
ABOUT  
THE  
OTHER  
ELKON  
RECTIFIERS—  
100**

Model "A" Eliminator  
and 5 ampere chargers  
and the automatic Elkon  
Replacement Rectifiers  
E-16 and B-1

Radio Department  
**ELKON, Inc.**  
 Division of P. R. Mallory & Co., Inc.  
 350 Madison Ave., N. Y. C.

ELKON, Inc., Dept. E-16, 350 Madison Ave., New York City  
 Kindly send me complete information on Elkon Qual-  
 ity Radio Products

Name .....  
 Address .....

## Fixed and Adjustable Resistors for all Radio Circuits



### Bradleyunit-B

RADIO manufacturers, set builders and experimenters demand reliable resistors for grid leaks and plate coupling resistors. For such applications Bradleyunit-B has demonstrated its superiority under all tests, because:

- 1—Resistance values are constant irrespective of voltage drop across resistors. Distortion is thus avoided
- 2—Absolutely noiseless
- 3—No aging after long use
- 4—Adequate current capacity
- 5—Rugged, solid-molded construction
- 6—Easily soldered

Use the Bradleyunit-B in your Radio Circuits



### Radiostat

This remarkable graphite compression rheostat, and other types of Allen-Bradley graphite disc rheostats provide stepless, velvet-smooth control for transmitters, scanning disc motors and other apparatus requiring a variable resistance.

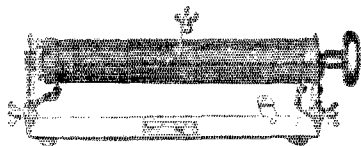

### Laboratory Rheostat

Type E-2910 — for general laboratory service. Capacity 200 watts. Maximum current 40 amperes. A handy rheostat for any laboratory.

Write for Bulletins!

ALLEN-BRADLEY CO., 277 Greenfield Ave., Milwaukee, Wis.

**Allen-Bradley Resistors**

eration. Now after a careful study of it I can see how the *Times* has advanced 2UO in a commercial way. However, here is something that might interest you. I was told by a member of the *Times*' radio department that the government has refused them a commercial license. . . .

I wish to hear from you again and would be willing to help you in any way that I am able.

—R. E. Study

(Editor's Note: Since the above was written, the *Times* has been given a commercial license, with the call WHD, and authority to operate on certain frequencies in the mobile bands, presumably as a station in the mobile service, i. e., as a "coastal" station. At that date, however, they were also retaining their amateur license, W2UO.)

## "ES" and "&" and Others

Hollywood, Calif.

Editor, *QST*:

The dissertation on "es" and "&" in the September issue reminds me of a couple of other things about our abbreviations, as we now use them, that possibly may be of interest to some of the "new generation."

The familiar ...— we call "sk"; but it isn't "sk" at all. Any old timer will tell you that it's "30", which, for so long that it has become tradition, has stood for "finish", "no more", "finale" or what have you, in the American Morse code. It probably came first into use when used in the telegraphing of news. It was the custom of newspaper offices when getting in a story that was coming along close to the "deadline"—or press time—to grab the story in sections from the receiving operator and rush it to the type-setter in installments; and the make-up department would continue assembling these rather disjointed sections of the same yarn until finally a sheet would come along with a "30" at the bottom, thus signifying that the story was complete. Then later it came into more general use denoting the finish of almost any telegraphic operation—and so it has passed on down to us with the same meaning. When writing the obsequies of a journalist, your newspaper writer will always complete the writing by the word thirty.

... (13), has for many years been the symbol for "understand" in American Morse; now it's ...—, we having dropped the "1".

"73"—so profusely used in "ham" lingo, has always stood for "Please accept my compliments"; and "88"—well, ask any old-timer.

Incidentally, that term "ham"—you can say what you want, and discuss to your heart's content, but in the old days its use was anything but complimentary to the addressee.

There are lots of others, and it is to be hoped that in the modern era we can hang



# When Considering Condensers — Consider the Facts!

WHERE mechanical strength and ruggedness are imperative and where electrical efficiency is vital, Cardwell Condensers are eminently fitted to meet the conditions. ☐ Were this not so, there is no other reason why the largest organizations identified with commercial radio and wire communication and apparatus, with their unsurpassed facilities for research and investigation, should use Cardwell Condensers, (both receiving and transmitting) year in and year out. ☐ The Army and Navy and other Governmental departments are Cardwell users, too. ☐ If there are names that loom larger, reputations that mean more or organizations that buy more carefully or with greater discrimination than these users of large quantities of Cardwell Condensers, they are not known to us, and continued use by them of any given product should, logically, establish its merit. ☐ So when next considering variable condensers, unless you can be satisfied with *LESS* than is demanded by those who *know*, Cardwell Condensers should be *your* choice, too.

## CARDWELL CONDENSERS *for all purposes*

VARIABLE—FIXED—TRANSMITTING—RECEIVING

---

“The Standard of Comparison”

---

[ Literature describing the Cardwell  
line will be sent you upon request. ]

The Allen D. Cardwell Mfg. Corp.  
31 Prospect St., Brooklyn, N. Y.

# Get into the COMMERCIAL RADIO FIELD where the MONEY IS

We've had hundreds tell us that they knew radio backwards and forwards. Yet they enrolled in our courses. And a few weeks after they started to learn radio the RIGHT way these same men told us that they never realized how much they had been missing right along.

Maybe you too have sufficient radio knowledge to build a few radio circuits. That isn't enough to make a real commercial success. What you really need is a course that takes you from the first elements of radio right through the most complex stages and gives you the practical knowledge you need for commercial work.

## RADIO INSTITUTE SPONSORED BY RCA, G-E AND WESTINGHOUSE

The Radio Institute of America is the world's oldest radio school, giving the finest and most comprehensive instruction obtainable. Our graduates are making real money—we'll send you copies of some of the letters they write us about their successes.

### STUDY AT HOME

Another feature of this course is that you can study at home—when you please and as long as you please. No need to give up your present employment. No time lost traveling back and forth to classes. Our new booklet tells how others—just like yourself—have won success in radio, and how you too can make this profession of fascinating brain-work your life career. You owe it to yourself to read this book through. If you will clip and mail the coupon, we'll send the book to you.



RADIO INSTITUTE OF AMERICA Dept. D-12  
326 Broadway, New York City

Please send me your booklet.

Name .....

Address .....

.....

on to a few of the old traditional ear-marks of American Morse.

—Clyde DeVinna, W6ZZK

## To Boycott Broad Signals

510 St. Charles Ave.,  
Birmingham, Ala.

Editor, *QST*:

By this time all active hams on the 40-meter band have noticed the arrival of WEM, and if their gray matter has functioned at all they have probably realized that WEM or some other commercial station will doubtless occupy that position in 1929, which will probably be the bottom of our 40-meter band. Now listen in on this band most any old time and see how many stations (or how few) with these rough broad notes it will require to fill the space on your dial from WEM to WIZ; then draw a cartoon of yourself working DX in 1929. I would imagine that proportion holds good in the other amateur bands also.

It has often been suggested that we do not work stations below or above the bands and personally I will not work them—and if it's necessary to use this scheme on the rough broad notes let's have it.

—M. B. Drennen, W4VC

(WEM is listed as being on 7,400 kc.—100 kc. above the edge of our 7,000-kc. frequency band.—*Editor*.)

## Yes, Sir!

732 Miller Ave.,  
Ann Arbor, Mich.

Editor, *QST*:

About two weeks ago I had occasion to send an important message to my father at Pasadena, Calif. From the station here at the University of Michigan (8AXZ) I gave the message to the only westerner on at the moment—a 7 about a thousand miles or more from the message's destination. The 7 was just readable, and after giving the message to him QRM bobbed up and blotted him out. In the hope of his copying and getting the message on, I repeated it and closed down. The interesting thing of this tale is that W6DYL—W6EHG, copied the message, and being quite close to Pasadena, mailed it. I have been out of the game for some time, and can't say whether this has become the practice, but I can say that this act of kindness was appreciated. The call of this man makes it look as if he is a newcomer, but at any rate it will suffice to show the old timers that courtesy still is in amateur radio.

—Archie Ekdale, W6SM, WSDQU

## International Friendships

Hotel St. Petersburg,  
Paris, France.

Editor, *QST*:

I would like to bring under your notice an incident that is worthy of note as rep-

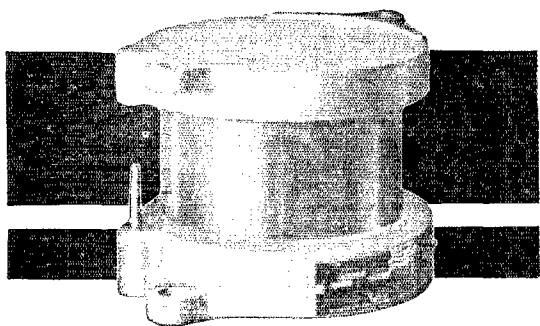

## *A Faradon for every capacitor need*

Satisfaction is built into Faradon Capacitors with the certainty that comes from years of experience, use of finest materials and rigid inspection throughout production. That is why Faradon Capacitors are the choice of leading radio manufacturers and amateurs.

Faradon engineers are glad to co-operate in supplying data for particular requirements not covered by the more than 200 types of Faradon Capacitors ready for prompt delivery.

WIRELESS SPECIALTY APPARATUS CO.

JAMAICA PLAIN, BOSTON, MASS., U.S.A.

*Established 1907*

# *Faradon*

---

*Electrostatic Condensers for All Purposes*

---

# Dubilier

## TRANSMITTING CONDENSERS

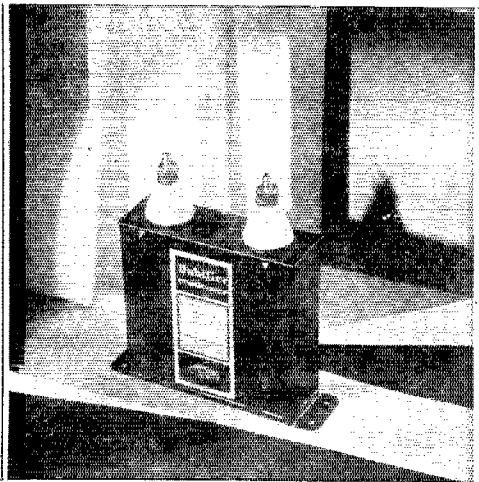

**D**UBILIER type 686 condensers have the usual Dubilier high safety factors for use in transmitter filter net works. 1000 volt DC rating.

May be connected in series where the working voltage exceeds 1000. Through series parallel connections practically any working voltage and capacity can be obtained.

DC voltage must not exceed 1000; or in A.C. supply filter circuits the transformer voltage must not exceed 750 volts per rectifier plate.

1 mfd. condenser \$5.00  
2 " " \$8.00

Write Dept. 41  
for free catalog

# Dubilier

## CONDENSER CORPORATION



10 E. 43rd St.  
New York City

representative of the sentiment of brotherhood that is so noticeable in our world of amateur radio.

I have been on vacation in Europe for six months, and on my arrival I wrote to ef8GI stating that I should feel proud of an interview and inspection of his shack. The answer was by return post, and a cordial invitation was given me.

It was not until 5 months after reception of the invitation that I could make the visit and then ef8GI called at my hotel in his automobile and drove me around Paris, thence to his home.

Our conversation was limited as he spoke little English and I very little French, but with the aid of a dictionary, international abbreviations, and a Morse key we were able to compare notes and tell each other of our respective systems.

On my leaving, 8GI asked me, as best he could in the two languages, if I would accept as a souvenir a kilowatt tube, to take to Australia as a symbol of the International feeling of friendship that exists at the present time.

Can anybody get away from the fact that International Amateur Radio is one of the finest influences toward world friendship that has ever existed?

—E. S. Yorston, ou3ES

## A Real Problem

922 Mulberry St.,  
Mt. Carmel, Ill.

Editor, *QST*:

I cannot help thinking that all these fine articles in *QST* by Hull, Bourne and others have, for a great many amateurs, been words in vain. Personally, I believe that these types of transmitters are the solution to our problem, combined, of course with good receivers and I believe the attitude of many amateurs is similar to that of one prominent traffic "ham" here in the middle west who said, "I think this new type transmitter stuff is unnecessary—our present stations manage to get out all right. 40 meters is the only band on which we might need them and most hams will be on 80." (As if we didn't need them on 80 meters!)

I think we have the solution to the technical problems but the real problem now is to impress upon the amateur the need of using the new 1929 developments.

—John O. Weaver, W9AYB

## In Appreciation

1217 South Normandie Ave.,  
Los Angeles, California.

Editor, *QST*:

At the Radio Show in Los Angeles, Sept. 2nd to 8th, the Amateur Radio Research Club was in charge of the A.R.R.L. booth and operated station W6PS there.

# Radio Will Be Different in 1929

The Only Handbook Prepared for the Change is

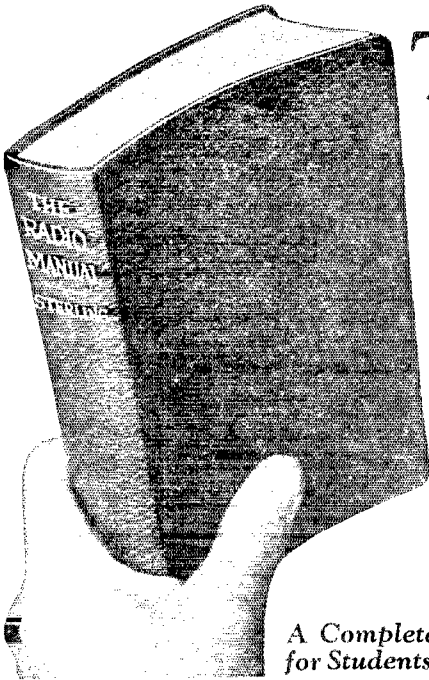

## THE RADIO MANUAL

By G. E. STERLING, Radio Inspector and Examining Officer, Radio Division, U. S. Dept. of Commerce.

Edited by ROBERT S. KRUSE, for five years Technical Editor of QST.

The new procedure adopted by the International Radio Telegraphic Convention is effective January 1st, 1929. THE RADIO MANUAL records it completely. Department of Commerce examinations for operator licenses will be changed the first of the year. Only THE RADIO MANUAL presents all the material to meet the requirements of the questions. Progress has been steadily made in perfecting radio theory and practise. THE RADIO MANUAL, since it is the most up-to-date volume on radio, is the surest source of complete and accurate information on all points.

*A Complete Handbook of Principles, Methods, Apparatus for Students, Amateur and Commercial Operators, Inspectors*

### Complete Preparation for Government License. 16 Chapters Covering

1. Elementary Electricity and Magnetism
2. Motors and Generators
3. Storage Batteries and Charging Circuits
4. Theory and Application of the Vacuum Tube
5. Fundamental Circuits Employed in Vacuum Tube Transmitters
6. Modulating Systems Employed in Radio Broadcasting
7. Wavemeters, Piezo-Electric Oscillators, Wave Traps and Field Strength Measuring Apparatus
8. Marine Vacuum Tube Transmitters including detailed description of Model ET-3626
9. Radio Broadcasting Equipment including, for the first time in any text book, the complete equipment of Western Electric 5 Kilowatt broadcasting Transmitter used in over 75% of American broadcasting stations.
10. Arc Transmitters including description of Federal Marine 2 Kilowatt Arc Transmitter Type AM 4151; also models "K" and "Q"
11. Spark Transmitters including description of Navy Standard 2 Kilowatt Transmitter
12. Commercial Radio Receivers and Associated Apparatus including, for first time in any text book description and circuit diagram of Western Electric Superheterodyne Receiver Type 6004C
13. Marine and Aircraft Radio Beacons and Direction Finders.
14. The Development of Amateur Short Wave Apparatus. Complete details of construction, operation and licenses.
15. Radio Laws and Regulations of the U. S. and International Radio Telegraph Convention. Quotations of all important sections
16. Handling and Abstracting Traffic

## Examine It Free

Never before has so complete a treatment of radio theory and operation been compressed into a single volume. Here is information that otherwise you could secure only by consulting many different books. And every detail is vouched for by authorities of the first rank. The Manual is profusely illustrated with photographs and diagrams. There are 700 pages, bound in flexible fabrikoid that is extremely durable. The immediate demand for so valuable a handbook has already nearly exhausted the second large edition. To be sure of receiving your copy without delay, order at once. The volume will be sent for free examination. Pay or return in 10 days.

### Order On This Coupon

D. VAN NOSTRAND CO., INC., 2 Warren St., N. Y.  
Send me THE RADIO MANUAL for examination. Within ten days after receipt I will either return the volume or send you \$6.00.—The price in full.

Name .....  
(QST 12-28)

St and Number .....

City and State .....

# FOR \$3.00 YOU CAN'T GO WRONG!

Of course, you are building a new short-wave set or rebuilding an old one and you can't go wrong if you are reading the series of articles Ross Hull has been running in *QST*. They present the findings of the A.R.R.L. Technical Development Program, of which Hull is Director, which have been disclosing a lot of interesting, and illuminating, facts about short-wave transmitters and receivers.

The Hull articles started in the August issue and ran in September, October and November. None appears in this issue while Hull saves up steam for January. Then there will be more.

Now, Here's The Good News—if you missed these late 1928 issues, we will send them to you, all four of them, and also enter your subscription for the entire year 1929 for the sum of \$3.00.

Can you beat this for a bargain?

-----  
*QST*, Hartford, Conn.

I need the dope. Inclosed find my \$3.00 for the late 1928 copies and a year's subscription to *QST* for 1929.

.....  
.....  
.....

It was my duty to select operators and to arrange schedules with stations outside to move the traffic. There were 2152 messages taken in and relayed—and it was a tedious job as they came fast and furious sometimes. At the show the A.R.R.L. booth was one of the most crowded of all, even including the "Television" booth. On behalf of the A.R.R.C. I wish to thank, many times, every station that handled a message from the L-A Radio Show. In spite of all that has been written about punk amateur operating I must say we worked some of the finest operators that are pounding brass anywhere!

Two outstanding events among the Los Angeles gang was that of 6AVJ relaying traffic to Europe in one jump and 6CHA's big total of 900—both one man stations.

I was also one of the operators at the National Air Races in Los Angeles and there, once more, amateur radio shone brilliantly. Once more we say "Hats off to that bunch of amateurs all over the world who helped us."

—Chas. A. Nichols, A.R.R.C. Vice President, W6ASM

## Request

6237 South Richmond Street,  
Chicago, Ill.

Editor, *QST*:

I have received a letter from 9BAN stating that while in QSO with 9KD, a man ran into his house and said that his roof was on fire. True enough it was. The roof and all ceilings and some parts of walls were soon no more. Up in the attic he had several years of *QST*, a 30-year file of Literary Digests and other literature. One of his most highly prized articles was the photo album that contained pictures of most stations with which he had been in communication. Out of this, all that he could save was his transmitter and short-wave receiver. The rest burnt up or was damaged by falling debris or water. In his behalf, I request that those amateurs who have been in communication with him please send a photo or two to replace those that have been burned, to make up another photo album.

This done, you'll surely enlighten 9BAN's heart.

—Walter Ostrowski, Jr., W9CMX

## Press Messages

United Press Association,  
World Bldg., New York City.

Editor, *QST*:

Some time ago a message addressed to the United Press, and presuming to come from the Rockford flyers, was picked up by several amateur radio operators at different points in the country. In one city—Toledo, Ohio, I believe it was—the member called one newspaper which did not happen to be

# NEW Console Model

A. C. TUBE

## Stromberg-Carlson

HERE is the wonderful Receiver you have dreamed of owning—a Receiver with the celebrated Stromberg-Carlson tone, at a price within the reach of everyone.

Not only the tone but its extreme sensitivity—its keen selectivity—its splendid workmanship tell you at once it is a Stromberg-Carlson.

This Receiver has a handy jack to facilitate playing records electrically through the wonderful audio system of the Receiver; thus making it possible to convert any standard phonograph into a high quality modern electrical reproducing instrument.

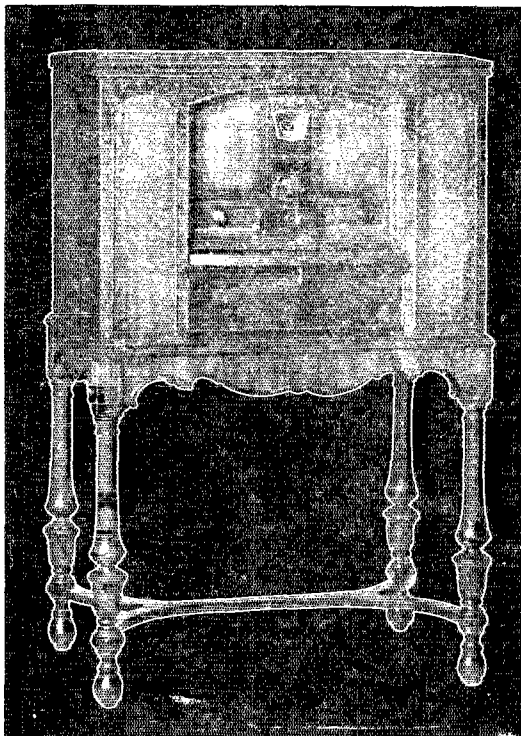

No. 636 Stromberg-Carlson Uses 5 UY-227 A.C., one UX-171-A Output Tube, and one UX-280 RCA Tubes. Price, less Tubes and Speaker, \$245. Slightly higher Rockies and West and Canada.

The beautiful cabinet sets a new standard in radio. It is low, artistically designed, with two-toned Walnut panels and top of matched Walnut butts. A slide which may be used as a writing table acts as a cover to close the front.

STROMBERG-CARLSON TELEPHONE MFG. CO., ROCHESTER, NEW YORK  
Listen to the Stromberg-Carlson Sextette through the N B C and twenty-two associated stations.

# Stromberg-Carlson

MAKERS OF VOICE TRANSMISSION AND VOICE RECEPTION APPARATUS FOR MORE THAN 30 YEARS

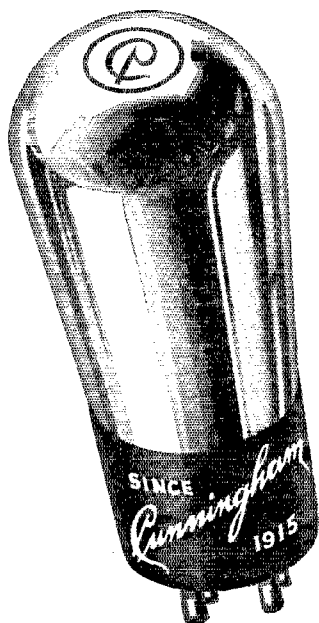

Give Cheer  
throughout  
the year with

**Cunningham**  
RADIO TUBES

As the Yule-logs crackle and music fills the air, enjoy the Christmas melodies to their utmost by having a new Cunningham Radio Tube in every socket of your radio.

These "ambassadors of joy" make delightful Christmas gifts.

**E. T. CUNNINGHAM, Inc.**  
New York Chicago San Francisco

Manufactured and sold under rights,  
patents and inventions owned and/or  
controlled by Radio Corporation of  
America

the United Press newspaper in that city, and when he was told that it was not the United Press newspaper he gave them the message and it was sent out over Associated Press wires.

It occurred to me that such messages might come through the air from time to time in the future and be picked up by amateurs at different points who might not know how to reach the United Press. Therefore I am enclosing a list\* of the United Press bureaus with their local addresses, and we will greatly appreciate, if you see fit, the printing of this list in your service paper so that any member of your League, should he receive a message addressed to the United Press at any time in the future, could phone or wire the nearest United Press office, tolls collect.

With best wishes,

Sincerely yours,

R. J. Bender, Vice President.

[\*The U. P. Bureaus are located as follows: Albany, N. Y., 16 Beaver St.; Atlanta, 205 Throver Bldg.; Austin, Tex., State House; Boston, 262 Washington St.; Buffalo, 30 Naylor Bldg.; Chicago, 220 S. State St.; Cleveland, The Press; Columbus, Ohio, The Citizen; Dallas, The Journal; Denver, The News; Des Moines, 308 Securities Bldg.; Detroit, 711 Polk Bldg.; Fresno, Calif., Bee Bldg.; Harrisburg, Pa., Patriot Bldg.; Indianapolis, Times Bldg.; Kansas City, Mo., Journal-Post Bldg.; Lansing, Mich., Capital-News Bldg.; Lincoln, Nebr., Box 1509; Los Angeles, The Record during day, The News at night; Madison, Wisc., The Journal; Memphis, Press-Scimitar Bldg.; Milwaukee, 528 Chestnut St.; Montreal, Que., 171 St. James St.; New Haven, The Time-Union; New Orleans, 720 Union St.; New York, World Bldg.; Oklahoma City, The News; Omaha, The Tribune; Philadelphia, The News; Phoenix, Ariz., 609A Heard Bldg.; Pittsburgh, New Press Bldg.; Portland, Ore., The Journal; Sacramento, 702 "I" St.; San Francisco, 340 Ninth St.; Seattle, Star Bldg.; Springfield, Ill., 311 1/2 S. 6th St.; St. Louis, Star Bldg.; St. Paul, News Bldg.; Salt Lake City, 414 Clift Bldg.; Washington, 1322 New York Ave., N. W.—Ed.]

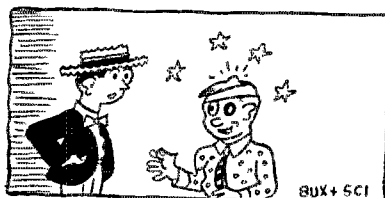

"WHASSA MATTER, OM, AUTO WRECK?"  
"A BED SLAT BROKE LAST NIGHT AND I  
FELL AND HIT THE CEILING"  
"IMPOSSIBLE, OM, THAT WOULD BE DEFYING  
THE LAWS OF GRAVITY"  
"BUT YOU SEE I HAD A THOUSAND VOLTS  
OF 'B' BATTERY UNDER THE BED"



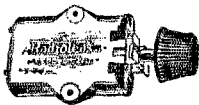

Bradley Leak, absolutely noiseless and stepless, **2.95**

2000 to 30,000 ohm resistance. List \$5, special \$2.95.

\$4. Bradleystat No. E-210 Special ..... 1.60



Signal Buzzer Set International Code on Backboard ..... \$2.45  
Belden braid 1/4 inch wide, ft. .06

\$7. Acme B-6—"B" eliminating transformer, 235 v. each side of centre tap. ... 2.45

Acme 500 w. plate transformer, 1000-1500-2000 each side of centre tap, 24.00.  
Acme 4:1-1 transformer, 355-510 each side of centre tap; also 2 fl. windings of 4 v. each side of centre tap, \$10.25.  
Acme C.W. 30 Henry choke, \$18 list—150 M. A. single \$14.40; all other sizes at special prices.

### ACME POTENTIOMETER RHEOSTAT

A combined Pot. and filament Rheo.

4 ohm rheo-100 ohm pot.  
30 ohm rheo-100 ohm pot.  
30 ohm rheo-300 ohm pot.  
TWIN RHEO for low voltage tubes. List \$3.00. Special each 65c



### ACME TRANSFORMER

Listed at \$5.00. The universal transformer for Super Het. 30 K.C. Limited quantity at \$1.10

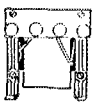

### ACME CHOKE COIL

A high quality choke 1/16 Henry at 100 mila. List \$5.00. Special \$1.25

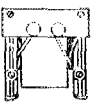

### French Hand MICROPHONE

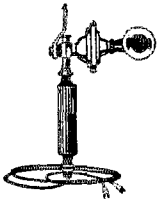

Listed at \$10 Nickel Silver Finish Vulcanized rubber handle.

A wonderful buy \$6.25 at . . . 6

# LEEDS

The Home of RADIO  
45 VESEY STREET  
NEW YORK

New York's Headquarters for Transmitting Apparatus

When in Town Visit Our Store  
Full Line of Acme -- Thordarson -- Jewell -- Flechthelm -- General Radio -- Signal -- Bradley

### SPECIALS

- Dubilier Mica Condenser, .002 cap, 6,000 working volt 1.95
- General Radio 247D .001 cond. plate or with vernier 1.75
- Dubilier cond. 1.7 mfd. 1,000V D. C. test; 650 v. working voltage 1.35
- Dubilier cond. .5 mfd. 1,000V D.C. working voltage 1.35
- R.C.A.—U.V. 1716 Super Het. transformer 1.45
- Ward Leonard Resistances; fits standard base receptacles; sizes 300—600—900—1200 and 2000 ohms .95
- \$15. Imported German head sets; very sensitive 3.45
- Honeycomb Coils unmounted, all sizes in stock at 1/2 price. \$8
- Signal Corp adjustable arm micro-transmitter for panel mounting 2.45
- \$9. Dubilier condenser, 4 mfd; 600 v. D. C. working type 903; limited quantity 2.45
- R.E.L. Transmitting Inductances, per set. 5.80
- Bristol 50 Henry choke 2.75
- 6.50 Acme .0005 enclosed condenser .95

Pyrax Low-loss V.T. sockets, each 39c.

R. C. A. socket; porcelain base, metal top 50c

Cardwell condensers, double spaced for transmitting, .00025 cap. **3.45**

No. 12 Enameled copper wire, any length, ft. .... \$1.01

No. 10 Enameled copper wire, any length, ft. .... \$1.01 1/2

Genuine Bakelite Panel 10x14x1/4 ..... 1.50

Baldwin phones type C, pair 5.95

Myers \$5 1/2 volt Det. or Amp tube, complete with mounting clips ..... .95

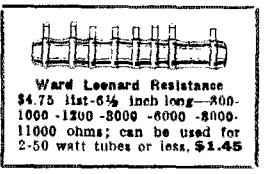

Ward Leonard Resistance \$4.75 list—6 1/2 inch long—200-1000-1200-3000-6000-\$800-11000 ohms; can be used for 2-50 watt tubes or less, \$1.45

Television disks as specified in QST special \$1.95.

### ACME VARIABLE RATIO AUDIO FREQUENCY TRANSFORMER

Get any ratio you want.

#### SPECIFICATIONS

RATIO	Type V A-2		Ratios Available	
	Primary Posts	Secondary Binding Posts	Primary Binding Posts	Secondary Binding Posts
2.5:1	1-4	5-6	4.25:1	1-3 5-8
3:1	1-3	5-6	4.75:1	1-3 5-7
3.25:1	1-4	5-7	5.25:1	1-3 5-8
3.5:1	1-4	5-8	7.5:1	2-4 5-6
3.75:1	1-2	5-8	9.5:1	2-4 5-7
4:1	1-8	5-7	11.5:1	2-4 5-8

On the primary side the binding post in use having the higher number should be connected to the B+ and likewise, the secondary post having the higher number should be connected to the grid.

By using binding posts 2-4, still higher ratios may be obtained if desired, but the above selection will usually fill all requirements.

Other specifications similar to type A-2. Price \$7.00 each. Special ..... \$2.75

### GENERAL RADIO POWER AMPLIFIER and "B" ELIMINATOR KIT

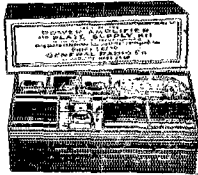

All necessary parts; operates from 105 to 125 volts A. C.—gives "A" "B" and "C" for amplification and "B" for set. Type 300 uses type 371 and 380 tube. Type 395

uses B. H. Raytheon and 371 tube. List \$50. Special ..... \$19.50

MAIL ORDERS FILLED SAM' DAY 10% Must Accompany All Orders

PLEASE PRINT YOUR NAME AND ADDRESS PLAINLY to AVOID DELAY

### NEON LAMPS



Made by General Electric Co., type G. 10, standard base. 101 tubes, as illustrated in QST May issue page 17 Price only 95c

### RADIO FOUNDATION TRANSFORMER

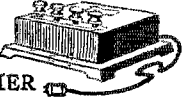

Mfg. for McCullough A. C. or equivalent tubes. Will carry 6 or 7 tubes—240-375 volts. List \$6.00. Special ..... \$2.25

### VARIABLE FILAMENT TRANSFORMER

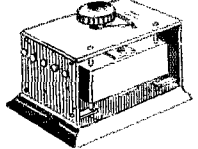

125 watt—110 volt—60c, tapped at 4-7-10-18-17-20-24-50 volts. Limited quantity. List \$19. Special ..... \$4.45

Flechthelm Condensers, all types 35% off list.

General Radio No. 558 Short Wave Meter, 14 to 225 meters, list \$22, special \$15.00.



We carry the largest stock of GENERAL RADIO PARTS in the country

(Continued from Page 51)

# OFFICIAL NATIONAL WHOLESALE DISTRIBUTORS

## AERO COIL

This year Aero has a notable line of short wave apparatus for both receiving and sending. We have a complete stock of the entire line and are ready at all times to make instant shipment.

An outstanding number in the new Aero line is Type 50 Transmitter for light socket operation. Lists for \$148.75 and nets the "Ham" at our special price, \$87.46. Order by No. RQ-3680.

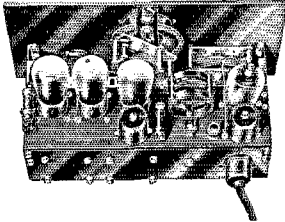

## Aero "International" Short Wave Receiver

New and better. Employs one Stage aperiodic shield grid amplification. Four tubes—one tuning control. New Aero audio transformer. Panel 7 x 14 in. Complete Kit of parts lists at \$55.30, our special price to Hams \$32.52. Order by No. RQ-3670.

**All Hams Should Have Our  
Big Wholesale Radio Catalog  
—Write for It**

Contains entire Aero line as well as 100 pages of other popular radio kits, parts, sets, accessories, and consoles. Lowest prices. Quick service. Write for your Free Copy.

## Setbuilders Supply Co.

166 Romberg Building  
CHICAGO, ILLINOIS

2. The Headquarters officers of the Union serving in that capacity on the date of the adoption of these provisions shall present to the membership the determination of the member to serve as the initial Headquarters under this Constitution, together with all offers and proposals that have been received bearing on the question. The affirmative vote of a majority of the members shall select the member chosen for the Headquarters. The headquarters officers as of the date of the adoption of these provisions shall promptly certify the result of the selection to all the members, shall inform the member chosen as the Headquarters, and immediately shall transfer to the Headquarters all records, funds, papers, correspondence and other property of the Union.

3. Any member at any time may propose a change in the location of the Headquarters, and the Headquarters shall present this to the membership as a Proposal on the next subsequent Calendar. If a member serving as the Headquarters finds it necessary for any reason to discontinue its services as such, it shall promptly acquaint the membership with the fact and the reasons in the next subsequent Calendar, and shall solicit offers and proposals for the selection of a successor. As promptly as possible it shall then conduct and confirm a special election to select a successor, in the same general fashion as prescribed in Paragraph 2 of this Article for the initial selection. When the new Headquarters has been determined and has accepted the appointment, all the records, funds, papers, files and property of the Union shall immediately be transferred to it, and the old Headquarters shall then stand relieved.

5. The officers of the Union shall consist of a president, a vice-president, and a secretary. The president, first vice-president and corresponding secretary of the member society chosen as the Headquarters of the Union shall serve in their respective capacities as officers of the Union during their society's term as Headquarters; provided, however, that no person commercially identified with the manufacture, sale or rental of radio apparatus shall be eligible to serve as an officer of the Union; and provided further that any national officer of a member society chosen as the Headquarters shall have the option of declining to serve in a similar capacity for the Union. Whenever, either through ineligibility or unwillingness to serve, there is a vacancy in any office of the Union, the member society serving as the Headquarters shall recommend to the Headquarters another qualified and responsible official of its society for the post, which recommendation the Headquarters shall convey by the Calendar to the membership, and the affirmative vote of a majority of the members shall serve to elect such substitute to the vacant post. All officers of the Union must be residents of the country whose society is chosen as the Headquarters.

### ARTICLE IV—MANAGEMENT

\* 1. The President shall have general supervision of the affairs of the Union. He shall preside at any meetings which are held in the name of the Union. He shall be responsible for and shall direct the work of the Secretary in the handling of correspondence, records, funds, and the Calendar. The Vice-President shall be responsible for such matters of general supervision as may be delegated to him by the President, and in the absence or disability of the President shall act in his stead.

2. The Secretary shall be the manager of the routine affairs of the Union, under the direction of the President. He shall conduct the general correspondence of the Union and shall maintain files and keep full records of all actions taken. He shall record the proceedings of any meetings held in the name of the Union. Whenever the Union has funds of its own, as distinct from the funds of the member-society serving as the Headquarters, the Secretary shall be responsible for their safe-keeping and shall account for them to the President. The Secretary, under the direction of the President, shall arrange and issue the Calendar, and shall handle the correspondence and records in connection therewith.

3. For the purpose of securing international agreement amongst the member societies on matters concerning their common welfare, proposals may be made by any member by letter addressed to the Headquarters. The officers of the Union may also originate proposals. All such proposals shall be



# There Is a Santa Claus!

( 'Tis the nite after Christmas,  
 In the shack you can see  
 Joe Zilch, Boston Ham, work  
 W2-ME.

**IT'S A SHAME** we can't guarantee W2-ME communication but if you stock up with REL new, improved High Frequency apparatus you'll tell the world there is A Santa Claus—an' how!

REL's new apparatus is the silver lining for the dark clouds of narrowed wave bands. New condensers, precision frequency meters, a new plug-in coil, and then—HEAVEN'S GIFT TO THE AMATEUR—a transmitting kit, totally enclosed and shielded in a handsome metal cabinet. Get hep to what the well-dressed heap is wearing!

## Merry Christmas

Free and useful information on how to build and use new 1929 receivers and transmitters is yours for the asking. 5 modern high frequency receivers, including the well-known standard regenerative receiver, a circuit employing the Screen Grid tube and also the new super-heterodyne are some of those described.

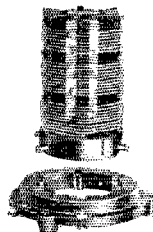
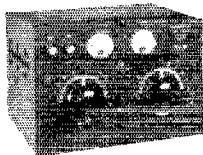

**RADIO ENGINEERING LABORATORIES**  
 100 WILBUR AVENUE, LONG ISLAND CITY, NEW YORK



Truthfully Humless

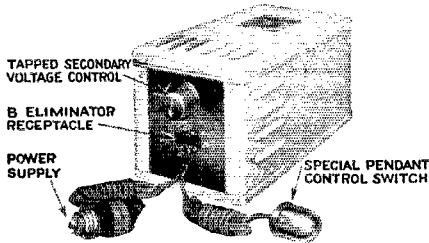

**A COMPLETE DRY-"A".  
ELIMINATOR**

Which will do its work and do it well.  
110-120 Volts. 50-60 Cycles.  
Generous 2 1/4 Ampere Output.

List Price \$35.00

Tobe Deutschmann Company  
Canton, Mass.

New York

Chicago

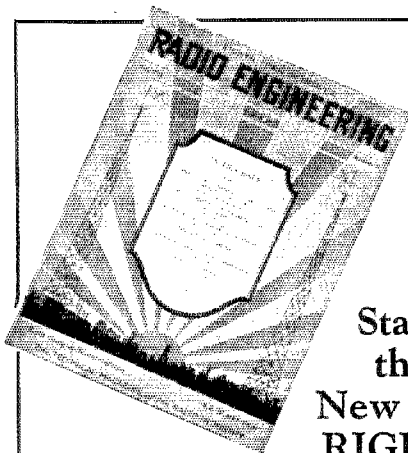

Start  
the  
New Year  
RIGHT!

Radio Engineering,  
52 Vanderbilt Ave., N. Y., N. Y.

Enter my subscription to Radio Engineering  
for 1 yr. at \$2.00—2 yrs. at \$3.00.

Name .....

Address .....

Town & State .....

Please check your  
Classification    Manufacturer   
                                 Dealer  Technician   
                                 Anything Else .....

listed by the Headquarters on a Calendar, which shall be sent to all the members and their votes by post solicited thereupon. In the determination of the affairs of the Union, every member society shall have one vote. Except in the selection of officers and the Headquarters, wherein it has previously been provided that action will be determined by a majority vote of the members, all Union action will be determined by the concurring vote of two-thirds of the members of the Union, and any proposal not receiving the concurring vote of two-thirds of the members will be adjudged lost. Proposals thus enacted shall become binding upon all the members of the Union; provided that every member shall have the privilege of making reservations in endorsing a proposal or of declining to abide by it if it is contrary to the laws of its country, its own constitution or by-laws, or established policies.

4. The Calendars shall be issued to the members by the Headquarters in June and December of each year. They shall be numbered serially and dated. The proposals contained therein shall be numbered consecutively and shall bear the name of the member making them. Proposals received at the Headquarters shall normally await the issuance of the next Regular Calendar but whenever in the opinion of the President a proposal is of too great importance to await the next Calendar, a Special Calendar shall immediately be issued to bring the proposal before the membership.

5. Members shall maintain on file at the Headquarters the address to which their official correspondence should be addressed. Members shall be bound to return their vote to the Headquarters on the proposals of each Calendar by the earliest possible post. As quickly as the action of the Union is determined, the Secretary shall acquaint the members with the results and shall announce which proposals are inaugurated and which are lost.

6. A report on the progress and status of the affairs of the Union shall be made to the members by the Headquarters in the December Calendar of each year. The Headquarters may also include in any Calendar any information of interest to the members, and may list as proposals any matters on which the Headquarters desires the opinion or instructions of the membership. The Calendar shall be, in general, a medium for presenting the business of the Union to the members for action.

7. Whenever an international communications conference affecting the interests of amateur radio communication is to be held in any country, the member society of that country shall acquaint the Headquarters with the situation as completely as possible. If the Headquarters finds in the situation any matters of common concern which should be the interest of the Union, it shall promptly calendar the matter to the membership; and if any agreement is reached as to the desire of the Union, shall make such arrangements as to it seem appropriate for the representation of the Union at that conference. Member societies shall be bound to undertake to represent the interests of the Union at such conferences held in their country, in accordance with instructions from the Headquarters, if so requested by the Headquarters.

8. The Headquarters shall give such encouragement and aid as is possible to the development of amateur radio in countries not represented by membership in the Union, to the end that there may come into existence in such countries strong and stable societies devoted to the welfare of the communicating amateur and which may thereupon be invited to apply for membership in the Union.

ARTICLE V—AMENDMENT

1. This Constitution may be amended by a two-thirds vote of the entire membership of the Union, by proposal on any Regular Calendar.

The editor of this department is pleased to note that several additional countries are now officially represented by official correspondents. Some of the reports are rather short, but the point is that they are coming in. It is again urged that news of national scope be stressed in these reports, with as little mention as possible being made of individual station reports, except in cases of unusual importance.

# For Every Radio Use

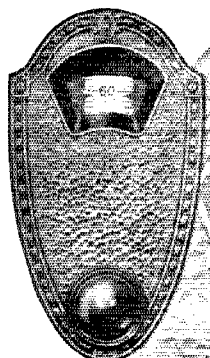

**TYPE F**  
Velvet Vernier Dial  
Dial. List Price \$4.00  
Type 28 Illuminator .50

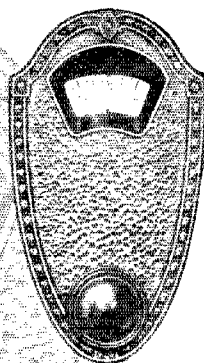
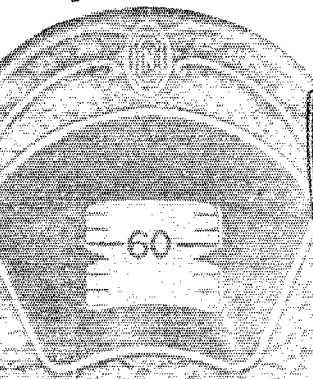

**TYPE E**  
Velvet Vernier Single  
Dial. List Price \$2.75  
Dial Illuminator .50

There is a National Velvet Vernier Dial for short-wave receivers and transmitters, for broadcast sets, for every type of radio-laboratory apparatus. National Velvet Vernier Dials are standard equipment of a large number of nationally known manufacturers and are used and approved by countless members of the ARRL.

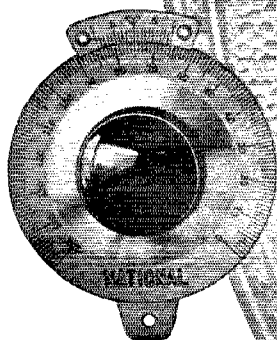

**TYPE N**  
Precision Velvet Vernier Dial. Solid German Silver. 4" Diameter.  
List Price \$6.50

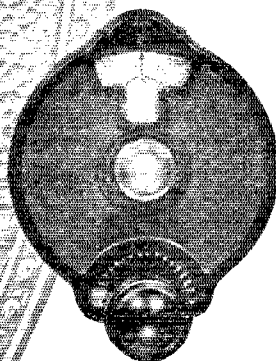

**TYPE B and C**  
Velvet Vernier Dials  
Type B (nickel)  
List Price \$2.50  
Type C (nickel) with bulb. List Price \$3.00

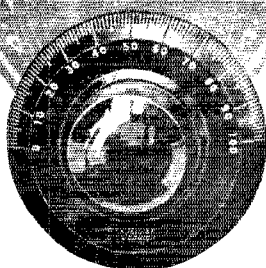

**TYPE A**  
The Original Velvet Vernier Dial. 4" Diameter.  
List Price \$2.50

## NATIONAL

### VELVET VERNIER DIALS

NATIONAL CO. INC., W. A. READY, PRESIDENT MALDEN, MASS.

# This Issue Completes the 1928 Series of QST

YOU'LL want to keep these  
copies as a unit — and  
the best way to do so is to put  
them in a

## QST Binder



Note the wire fasteners.  
Unnecessary to mutilate  
copies. Opens and lies  
flat in any position.

One-fifty each  
postpaid

A binder will keep your QSTs always  
together and protect them for future use.  
And it's a good-looking binder, too.

QST  
1711 Park St., Hartford, Conn.

## BRITISH SECTION NOTES FOR SEPTEMBER

By R. S. G. B.

All British amateurs have now received a memorandum from the P. M. G. concerning licenses for next year. The conditions are in many respects similar to the present ones, the chief changes being as under: All calls are to include the nationality prefix G as an integral part of them, preceding the numeral; eg2HJ becomes G2HJ. The frequency bands allotted are 1740 to 1970 kc., 7050 to 7250 kc., 14060 to 14340 kc., (the 20-, 40- and 150-metre bands allotted by the Washington Conference less certain "tolerances" at each end). Efforts have been made by the R. S. G. B. to get the full width of the bands but the greatest concession obtainable is that the Postmaster will reconsider the matter after a year. Previous experience, however, leads him to believe that such tolerances will be necessary to avoid QRM with other services. The 80-metre band is closed except for extra special work, the permits being issued rather like the old 32-metre permits. The ten- and five-metre bands may be obtained where special justification is shown.

The other important condition is that every station must have a quartz crystal wavemeter to ensure the emissions are on the licensed frequencies. Permission is granted to work stations in foreign countries and also to "exchange personal messages of an unimportant character." A.c. plate supply and i.e.w. are forbidden, although telephony is permitted. Not so bad, is it OM's—but those wavemeters will be expensive!

The chief event of the month was the R. S. G. B. Third Annual Convention held in London the 28th and 29th September. At 5 p.m. on the 28th the gang gathered for tea and talk in the lounge of the I.E.E. At 6:15, after a presidential address by Mr. Gerald Marcuse, G2NM, acting for Capt. Ian Fraser, who was unfortunately absent in South Africa, two of our best-known DX men, G2OD and G2SZ-G2HM opened an extremely interesting discussion on frequency stabilization, the amateur's biggest problem today. The meeting broke up at 8 o'clock when the London gang entertained the provincials and incidentally pounded brass with considerable vigor. Bright and early next morning a party left to tour the General Electric Company's laboratories and works. The convention met again after lunch for a business meeting, at which much of interest and importance was discussed. At half past six, the dinner (great event of the Convention) was held and 126 hams sat down to a thoroughly informal and enjoyable repast; followed, when QRM permitted, by a musical program arranged by G2NM. Speeches were made and many toasts drunk, particularly to G2NM, and the gang was very pleased to see oa3OM, am1AB, fk2MS, ef-8QOA and ed7GB present, and certainly enjoyed their company. It was rather sur-

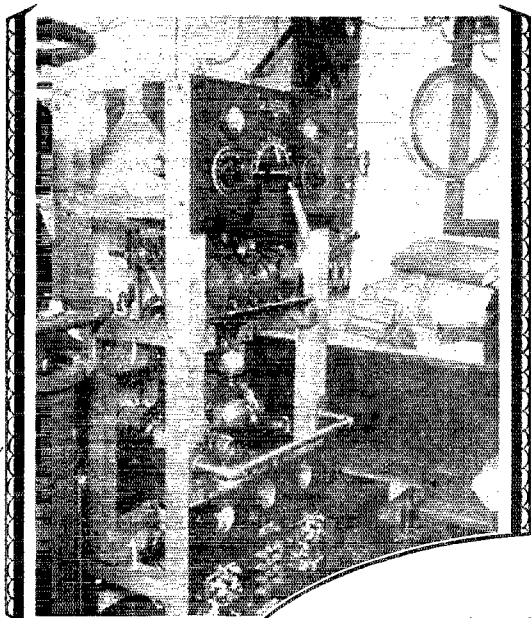

**BYRD'S  
RADIO**  
*is insulated  
with*  
**FORMICA**

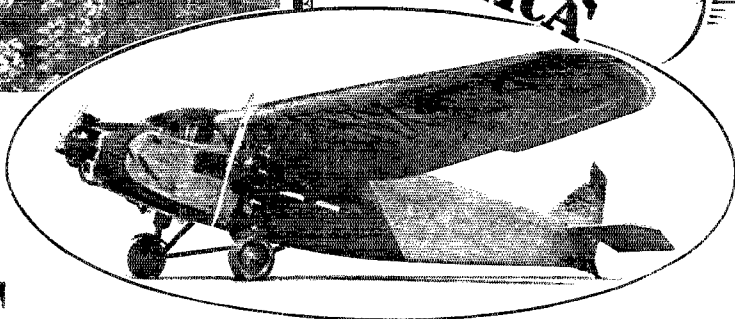

**F**ORMICA was used by the engineers, who designed the sending and receiving apparatus in use by the expedition, for panels, tubing and other insulating parts.

For fifteen years American radio men have known it as excellent insulation for high

or low frequency uses. It is high in quality and uniform—Phenol Fibre at its best.

Every year millions of automotive ignition systems, therapeutic apparatus, circuit breakers and electrical devices of all kinds are insulated with Formica. You can depend upon it.

THE FORMICA INSULATION COMPANY  
4620 Spring Grove Avenue                      Cincinnati, Ohio

**FORMICA**

Say You Saw It In QST—It Identifies You and Helps QST

## BE KNOWN BY OTHERS



The A.R.R.L.  
Emblem marks you as a  
'Real Ham'

**The Personal Emblem.** A handsome creation in extra-heavy rolled gold and black enamel, ½" high, supplied in lapel button or pin-back style. Either style emblem, \$1.00 each, postpaid.

**The Automobile Emblem.** Already being displayed on over a thousand cars. Size 5" x 2½", heavily enameled in gold and black on sheet metal, holes top and bottom, 50 cents each, postpaid.

**The Emblem Cut.** A mounted printing electrotype, the same size as the lapel button, for use by Members in any type of printing matter, letterheads, cards, etc. \$1.00 each, postpaid.

Mail your order NOW to

**A.R.R.L., Hartford, Conn.**

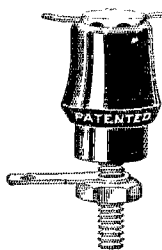

## POLK BINDING POST

SENSATION OF THE NATION

### INSULATED

No holes to fish for just press the sleeve and insert the wire in any position—it's quick and holds tight—standard markings.

15 cts. Each

**J. L. POLK, 41 Belle Ave., Troy, N.Y.**

## RADIO IN BRASIL

When in Brasil, apply to M. BARROS & CIA for anything you need in connection with radio.

**M. BARROS & CIA**

70 sob. Rua S. José 70 sob.  
Postal Box 89

**Rio de Janeiro**

Telegraph address, Radioparte, Rio de Janeiro  
Branch: Avenida S. João 4, S. Paulo, Brasil

prising to see no Americans there. Howcome OM's?

G6FT is residing in the United States at 1260 Madison Avenue, Paterson, N. J. and would be pleased to meet or hear from W hams.

The above report is exactly what we want to see here, and is sure to prove of interest to readers all over this world. We sympathize with all Britishers over that wave-meter requirement, but can't you get around it by taking advantage of the wording "or other approved type" which I believe is included in the language of the regulation?

### BELGIAN SECTION NOTES

By the President, EB4UU

An amateur short-wave transmitter has been installed by EB4FT and EB4WW on board the Belgian training, sailing vessel *L'Avenir*. This large, four-masted ship is bound, at the end of October, from Antwerp to La Martinique and then Tampa, Florida. The official call is XEB4WK and the wave about 32 meters, with a pure d.c. note. All qso's will be more than welcome; QSL's should be sent to the Reseau Belge, 11 Rue du Congres, Brussels, Belgium.

### HOLLAND

In recent correspondence between the NVIR and the headquarters office of the IARU it would appear that the long-hoped-for licensing of the amateur transmitters in Holland is at last in sight. No definite information on the restrictions is yet available, but it seems pretty evident that Holland amateurs will be licensed under some form about the first of the new year. Our very best wishes go to you all, OM's, together with congratulations on accomplishing this long wished-for end.

### JAPAN

Another country that has long imposed the severest kind of restrictions on its amateurs seems to be loosening up favorably. In a message to I.A.R.U. Headquarters via W6AM, we learn from AJ4ZZ that more Japanese amateurs are being licensed. During October the following were issued licenses: J3CC, J3CD, J3CE, J3CF, J3CG and J3CH. All are restricted to 38 meters and a maximum output of ten watts. FB, AJ's!

## NEW RELAYS

for amateurs and experimenters. We would be pleased to hear from you concerning your relay requirements.

If interested in television, write for our price list of television apparatus

**Photo Electric Devices, Inc.**  
594 Fifth Avenue Brooklyn, N. Y.





## Rising to the needs of a Great Industry

The requirements of the modern radio, are more and more exacting.

As receiving sets improve, coils must be more accurate to keep pace with the fine calibrations of the expert radio engineer.

This is why the world's most successful radio manufacturers turn to Dudlo for their supply of coils for every part of their instruments.

Dudlo coils are not only wound accurately, but every part and material from the core to the outside wrapping is selected and ap-

plied with skill—a skill which could only come from an organization trained over many years of making millions upon millions of coils for every electrical purpose.

No radio unit is any better than its coil and no coil is any better than the wire in its windings. Dudlo draws and insulates the wire and controls every part and process from the copper rod to the finished coil. A complete service to the radio and electrical industries.

**DUDLO MANUFACTURING CO., FORT WAYNE, INDIANA**

*Division of the General Cable Corporation*

56 Earl Street  
NEWARK, N. J.

105 West Adams St.  
CHICAGO, ILL.

4143 Bingham Ave.  
ST. LOUIS, MO.

274 Brannan St.  
SAN FRANCISCO, CALIF.

# To Our Readers who are not A. R. R. L. members

Wouldn't you like to become a member of the American Radio Relay League? We need you in this big organization of radio amateurs, the only amateur association that does things. From your reading of *QST* you have gained a knowledge of the nature of the League and what it does, and you have read its purposes as set forth on page 6 of every issue. We should like to have you become a full-fledged member and add your strength to ours in the things we are undertaking for Amateur Radio. You will have the membership edition of *QST* delivered at your door each month. A convenient application form is printed below—clip it out and mail it today.

*A bona fide interest in radio is the only essential qualification for membership.*

American Radio Relay League,  
Hartford, Conn., U. S. A.

I hereby apply for membership in the American Radio Relay League, and enclose \$2.50 (\$3 in foreign countries) in payment of one year's dues. This entitles me to receive *QST* for the same period. Please begin my subscription with the ..... issue. Mail my Certificate of Membership and send *QST* to the following name and address.

.....

.....

Do you know a friend who is also interested in Amateur Radio, whose name you might give us so we may send him a sample copy of *QST*?

.....

Thanks

## Some Suggestions for the Monitor

(Continued from Page 43)

If the single-pole switch is closed, the monitor will be in operation and can be adjusted to beat with the receiver. To listen in on the monitor, the double-pole switch is thrown to the right which connects the output of the monitor to the input of the last

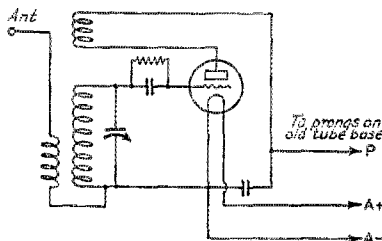

FIG. 2

audio stage, disconnecting the receiver at the same time. The single-pole switch is opened or may remain closed if the signal in the phones is too loud. However, in this condition there will be some change in the applied plate voltage which may shift the frequency of the monitor when the double-pole switch is thrown back to the other position.

All filaments are supplied from the same battery and are controlled by a filament lighting jack. The radio frequency chokes may not be needed. If they are necessary and are omitted, the circuit action will be cranky.

Continued use of this system has resulted in the monitor's becoming almost as necessary to operation as the receiver itself. Information as to frequency, steadiness, note, list and all signal characteristics are constantly "on tap."

## Relieving the Glass Arm

(Continued from page 40)

dash will be the result of a definite impulse from the arm muscles, which is an indication that the proper muscular action is taking place.

Following the drill on dots alone, it would be well to spend a few moments drilling on numerals and letters of the alphabet which are composed largely or wholly of dots. The numerals 4, 5 and 6, and the letters B, V, and S, when practiced at first separately, and later in groups, form very good exercises for limbering the muscles of the arm for sending. It may be observed in some cases that there is added difficulty in forming combinations where three or more dots immediately follow a dash, all being in the same group, as in the case of the numeral 6 and letter B. If this is found to be true, the operator should devote special attention to these formations.

(Continued on Page 33)

# WHOLESALE PRICES

## On Everything in RADIO!

### 164 PAGES

This big catalog places before you one of the country's largest—and most complete—stock of radio kits, parts, accessories and consoles as well as one of the season's outstanding lines of A-C and D-C receivers. Every set builder—every dealer, in fact—all those interested in radio should send for their copy of this immense catalog.

# RADIO

MODERN RADIO SETS  
ACCESSORIES KITS AND PARTS  
1929

### Radio Service

Allied Service will prove a revelation to you in what radio service can really be. Allied Executives backed by years of training in radio, are practical men. They know radio. Their vast experience has built up around them an organization trained to serve. Months of effort have built up a tremendous reserve of stock that makes for prompt shipments; and this stock is new stock comprising the season's pick of such prominent manufacturers as Silver-Marshall, Tyrman, Aero, Hammerlund-Roberts, etc.

#### SET BUILDERS!

Set Builders, Amateurs and so-called "Hams" will delight in the unusual variety and remarkable value that are offered in standard kits and parts. Tremendous stocks—real organization—prompt shipping service all combine to make Allied your ideal source of supply.

#### RADIO DEALERS!

The live radio dealer—the man who keeps pace with the rapid advance of radio—will find much of real interest in the Allied Catalog. New A-C Sets, D-C Sets, Dynamic and Magnetic Speakers, Television equipment, in fact everything an impatient radio public is demanding.

Write for Catalog Now!

CONFINED  
WHOLESALE  
PRICES

# ALLIED RADIO CORPORATION

711 W. LAKE ST. CHICAGO, ILL.

# Allied Radio CORPORATION

711 W. Lake St., Dept. P-1 Chicago

# In Stiff Buckram Binding

## The Radio Amateur's Handbook

Lies open and flat at any page

The invaluable Handbook with attractive and durable maroon leather cloth covers.

Will Wear Like Iron.

Price \$2 postpaid anywhere

A. R. R. L.,  
Hartford, Conn.

Stiff  
Binding

Gentlemen:

I've been wanting a better bound copy of the Handbook for a long time. Here are my two dollars.

### Choke Coil Design

(Continued from Page 34)

should be left between the copper and core to keep down the distributed capacity. Wherever insulating materials butt together, the length of the air gap from copper to core should be adequate to handle the high voltages encountered when trouble occurs. A flash-over usually carbonizes the bakelite surface, which then leaks and gradually is eaten away.

To protect the choke and other equipment from damage in the event of surges, r.f. chokes may be connected in both leads to delay the application of the voltage to the transmitter, while a sphere gap is connected across the choke sides of the r.f. chokes to flash over and dissipate the charge.

Next we must find whether or not the required number of turns of the necessary sized wire will go into the window space with the required insulation. Divide the winding space per pie by the diameter of the insulated wire, obtaining the number of turns per layer. Divide the number of turns per pie by the number per layer obtaining the number of layers. Add to the insulated wire diameter the thickness of the insulating paper between layers (7 mil fish paper is about right) and multiply the number of layers by this layer thickness, obtaining the depth of winding. From this figure, and the size of the insulating tubes, it may be determined whether or not the value of K chosen was correct. A sufficient air space should be left between the wire of opposite pies to insure against flash over.

We must next determine the total amount of wire required. The diameter of the mean turn is the sum of the outside diameter and inside diameter of the winding divided by two. This diameter expressed in feet is then multiplied by  $\pi$  to give the circumference of the mean turn, which multiplied by the total number of turns gives the length of wire required. The weight per thousand feet of the size wire to be used is obtained from a copper wire table, and multiplied by the number of thousands of

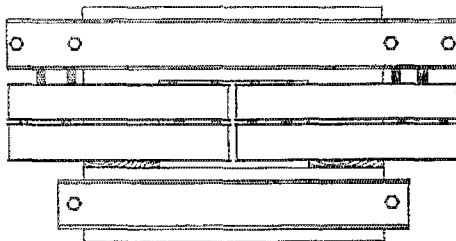
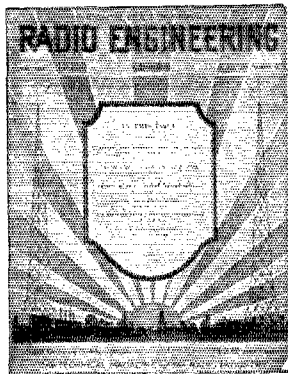

FIGURE 9

feet required, giving the weight of wire required. The length of No. 16 wire required for this example is about 3.12 thousand feet. This wire weighs 7.82 lbs per thousand feet, therefore  $7.8 \times 31.2 = 250$  lbs. of wire are required.

The resistance of No. 16 wire at 50° is 4.489 ohms per thousand feet. Therefore the d.c. resistance of this choke when in operation will be  $4.489 \times 31.2 = 140$  ohms. The copper loss will be  $2^2 \times 140 = 560$  watts,



Characteristics  
of Electric  
Wave Filters

by Clyde L. Farrar

Radio  
Inspection

by J. E. Smith

(In December Issue)

See Page 66

# Tyrman Imperial "80"

Custom-Bilt Shielded Grid

A-C  
Shielded  
Grid  
Tubes

Short  
Wave  
Plug-in  
Coils

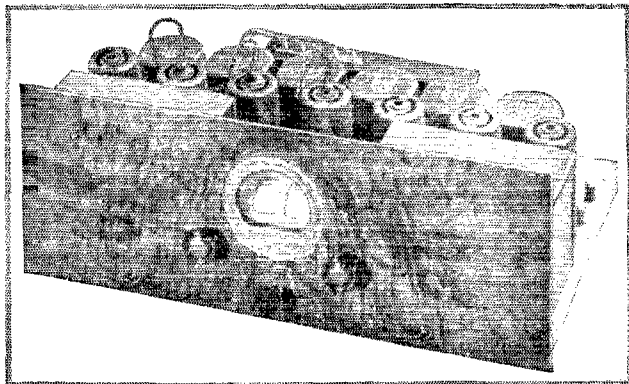

310 or  
350  
Power  
Amplifier  
Tube

Permanent  
Phonograph  
Connection

Tyrman "80" full A-C Socket operation using (3) A-C Shielded Grid (4) 327 (2) 381 (1) 350 or 310 Tubes. Dimensions 8" x 21" x 11½". One Spot-10 K. C. Separation. "The year ahead receiver."

## Advanced Engineering Principles You Will Appreciate

You who know radio will appreciate the advanced engineering principles and features incorporated in the Tyrman "80" as well as other Tyrman receivers

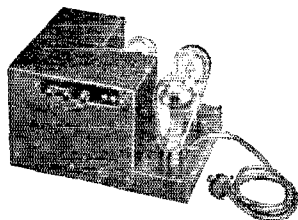

### "80" Power Supply

Powerful—Compact. Dimensions 8½" x 11" x 6¼". Phone tips provided for any type speaker. Directly energizes field of Dynamic Speaker. Factory packed, completely wired.

### Send for

#### FREE BOOK

showing schematic and wiring diagrams with full descriptions.

### TYRMAN ELECTRIC CORPORATION

Dept. 608, 314 W. Superior St.  
CHICAGO, ILL.

Send for free descriptive literature of Tyrman receiver kits using Shielded Grid Tubes. Battery and full A-C operation. Circuits you will quickly recognize as real engineering.

Tyrman "80" parts including Short Wave Coils and wired Power Pack complete, ready to assemble, \$199.50 list.

Tyrman "72" parts for battery or eliminator operation, complete ready to assemble, \$98.50 list.

Special Power Supply for "72" wired, \$55.00 list.

Tyrman "60" parts for battery or eliminator operation complete, ready to assemble, \$69.50 list.

#### TYRMAN ELECTRIC CORPORATION

Dept. 608, 314 W. Superior St.  
Chicago, Ill.

Without obligation, send me free literature describing Tyrman "80" for A-C operation   
Tyrman "72" A-C , Tyrman "72" battery operation , Tyrman "60" battery operation

Name.....

Address.....



**BUY  
CHRISTMAS  
SEALS**

**WOULD** you buy Christmas Seals if you knew they had helped to reduce the tuberculosis death-rate? In the past twenty years the death-rate has been cut in half—a saving of more than 125,000 lives in the year 1928 alone.

“Buy Christmas Seals,” for they are fighting tuberculosis every day of the year.

Christmas Seals give protection to your friends, to your family—and to you!

The National, State, and Local Tuberculosis Associations of the United States

FREE  
to  
You

## 1929 RADIO BOOK

New Hook-ups. This book shows how to make Short Wave Receivers and Short Wave Adapters. How to use the new screen grid tube in D. C. and A. C. Circuits. How to build Power Amplifiers, and ABC Eliminators. Up to the minute information on all new radio developments. Set Builders, Fans, Dealers, send for it today.

**KARAS ELECTRIC COMPANY**  
4030 M-N, Rockwell St., Chicago, Ill.

Please send me your free book \_\_\_\_\_

Name.....  
Address.....  
City.....State.....

4030-M



Write  
for it!

which is only 3.6% of the power transmitter through it. The voltage drop will be  $2 \times 140 = 280$  volts, which is only 3.6% of the applied 10,000 volts.

The detailed specifications for the core iron are next in order. The volume of iron will be  $2(6.5 \times 6 \times 6) + 2(24 \times 6 \times 6) = 2,196$  cubic inches or 1.27 cu. ft. The space factor for the core being 0.9, the volume of solid iron in the core is  $1.27 \times 0.9 = 1.143$  cu. ft. The weight per cubic foot of iron being 480 lbs., the total weight of iron required will be  $480 \times 1.143 = 550$  lbs.

The material chosen above for the core was No. 29 gage 4% silicon steel. The thickness of No. 29 gauge sheet is 0.014". As our core legs are to be stacked 6 inches thick, the number of laminations will be  $6/0.014 = 430$  sheets per leg. The top yoke will require 450 sheets 6" by 24". The bottom leg will require 450 sheets 6" by 18" staggered. 450 sheets 6" by 6.5" and 450 sheets 6" by 12.5" will be required for the two short legs, half of each for each leg.

The magnetic circuit must be broken up by an air gap to adjust the flux to the value of 50,000 lines per square inch decided on above with the two amperes of direct current flowing. The magnetomotive force IT produced, which is the product of the current and the number of turns in series required to obtain the specified inductance, is so large that an iron circuit 300 feet long would have to be used if additional reluctance were not inserted into the circuit. If no air gap were used, then the magnetizing force H would be about 460 ampere turns per inch for the iron, which is about 30 times that required to saturate this material. The choke would still function slightly under this condition but would have a very low inductance on account of the low permeability of the iron, and would act much as an air core choke.

The total number of ampere turns developed NI, must be used up in the iron ( $H_1 l_1$ ) and in the air gaps ( $H_a l_a$ ).  $NI = H_1 l_1 + H_a l_a$ .

$$H_1 l_1 = NI - H_a l_a, \text{ where}$$

$$H_a = 0.3132 B_r$$

if  $B_r$  is in maxwells per square inch, and  $l_a$  is in inches.  $H_1$  is the ampere turns per inch required to obtain the desired flux of density in the iron, and is taken from a magnetization characteristic of the material used. The quantity  $l_1$  is the mean magnetic path length in iron in inches.

Our equation for calculating the length of the air gap is now  $l_a = (NI - H_1 l_1) / (0.3132 B_r)$ .  $NI = 8,800 \times 3.3 = 29,000$  maximum.  $H_1$  was taken from the magnetization curve of the material chosen as shown in Fig. 26 of Sec. 4 of the Standard Handbook. This curve shows that  $H_1$  is 4.5 c.g.s. e.m. units, which is about 9 ampere turns per in. The mean magnetic path length  $l_1$  was taken from the sketch of the choke shown as Fig. 9, and was found to be 61 inches. The flux density in the air gap  $B_a$  is calculated from the flux density in the iron corresponding to the current I used, and the iron space factor.  $B_a = 80,000 \times 0.9 =$

# It IS Good!

40,000 (the number still grows) Copies of the

## Radio Amateur's Handbook

Are Referred to Daily for  
Guidance and Information

### Order Now

We believe that The Radio Amateur's Handbook, by F. E. Handy, Communications Manager, A.R.R.L. is the most valuable book which any amateur or experimenter could own. Its chapter headings will give an idea of the thoroughness with which the subject is covered. They are "What is An Amateur?" "Getting Started", "Fundamentals", "How Radio Signals Are Sent and Received", "Building a Station—The Receiver", "The Transmitter", "Power Supply, Keying and Interference Elimination", "Antennas", "The Wavemeter—Radio Measurements", "The A.R.R.L. Communications Department", "Operating a Station", "The Experimenter".

These chapters each occupy from ten to forty pages—indicating that each subject is treated in a thorough manner. In addition there is an appendix containing a fund of useful data. Then there is an index, occupying six pages, by which the valuable information contained in the book is made available. This in a particularly important point and has been compiled and cross-indexed with great care and thought. Altogether the Book contains 286 pages of the most valuable radio information ever found between two covers.

The Radio Amateur's Handbook starts at the beginning and tells what an amateur is, what the League is, what amateur radio is, how to become an amateur, how to learn the code, how to understand what you hear, how to get your licenses, how to build a simple station, how to build a better station, how to operate your station, how the A.R.R.L. works, how to handle traffic, how to conduct experiments and make measurements, and a multitude of other things too numerous to mention.

Anyone who is at all interested in the technical side of radio can ill afford to be without The Radio Amateur's Handbook.

Regular Cover \$1.00

Postpaid Anywhere

Bound in Leather Cloth \$2.00

*If you haven't  
a copy of The Radio  
Amateur's Handbook you  
are missing the greatest value  
in radio today.*

**DO IT** →  
**NOW**

AMERICAN RADIO RELAY LEAGUE,  
HARTFORD, CONN.

Dear Sirs:

Enclosed find my \$..... Please send  
me postpaid (any where in the world)  
my..... copy of the Handbook.

Name .....

Address .....

# FROST-RADIO

## Products that Satisfy

Products that satisfy *absolutely*—that's Frost-Radio. Every amateur need is met in the big Frost line of Quality Parts that are designed right, built right and sold at right prices. If you don't know Frost-Radio get acquainted with it today. Your local dealer probably handles it, or if not, can get it for you. Meanwhile, mail the coupon for copy of our catalog, the great amateur handbook of radio dope.

**HERBERT H. FROST, INC.**

Main Office and Factory

Elkhart, Indiana

Chicago

New York

San Francisco

HERBERT H. FROST, Inc.  
160 North La Salle Street, Chicago

Send me by return mail your 16-page catalog of Frost Parts. I enclose 10c.

Name .....

Street Address .....

City ..... State .....

72,000 lines per square inch. Solving for  $l$ , we obtain  $l = (29,000 - 600) / (0.3132 \times 72,000) = 1.26$  inches. As two gaps will be used, each one will be  $1.26 / 2 = 0.63" = \frac{3}{8}$  inches long.

The electrical design is now complete, and all that remains is to specify the mechanical details. The air gaps will be formed by 6" by  $\frac{3}{8}$ " pieces of wood placed on top of the short legs. The yoke will be kept in place by its own weight, the current helping to hold it down firmly when in use. To hold the yoke laminations solidly together all the way along, and so prevent the choke from acting as a poor loud speaker, heavy channel irons will be placed on each side and bolted together. Two pieces of 4" by  $\frac{1}{4}$ " channel iron 28" long will be required for the yoke.

The short leg laminations can be held tightly together by wooden wedges driven between the core and coil tubes. As shown in Fig. 9, the bottom channels are used to hold up the coils as well as to hold the core laminations together. For this purpose two 4" by  $\frac{1}{4}$ " by 36" channels are required. The bottom coil flanges are supported by wooden strips at intervals, the strips supporting the outside portions resting on the core. Several  $\frac{1}{4}$ " strips are placed between the pies to support the upper pie.

The inside end of the wire on each pie is brought out outside of the flange to increase the insulation and decrease the capacity as much as possible. The ends of each coil are soldered to binding posts mounted on the bakelite flanges. An odd number of layers is wound on each coil, so the inside end will be on one flange, and the outside end on the other.

### CONCLUSION

This choke was built according to the design worked out here. The use of this choke in place of the choke formerly used caused a noticeable lowering of the general tone of the station output. It also removed the crashes from the low notes. The monitoring was done with a crystal detector and headphones which the operators were accustomed to using. Please note that the lowered tone was not caused by attenuating the higher frequencies, as they were transmitted better than with the old choke due to its high distributed capacity.

The electrical design is now complete, and all that remains is to specify the mechanical details. The air gaps may be formed of 6"x6"x $\frac{3}{8}$ " blocks of a non-conducting material, such as wood. The bottom and top core legs should be bolted firmly together by means of two channel irons on each side of each leg. Heavy 2" channels would be about right. They should be bolted through the core in two places, thus clamping the core laminations firmly together, and preventing the choke from acting as a poor loud speaker. The top core leg may simply be placed on the air gaps, or it may be bolted to the bottom leg through the medium of heavy brass bars run outside of the windings. No magnetic material may be used shunting the air gaps.



## ALWAYS UP-TO-DATE

Issued quarterly, March, June, September and December. Single copies U.S. and Canada \$1.00 (Foreign \$1.10.) Yearly subscription \$3.25 (Foreign \$3.50.)

Amateur and Commercial Stations from 83 different countries.

**Radio Amateur Call Book**  
508 So Dearborn St., Chicago, Ill., U.S.A.

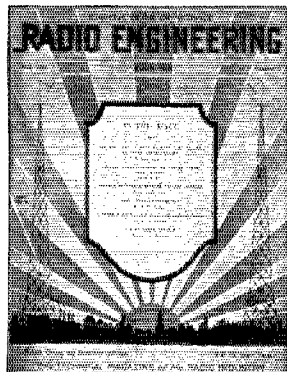

The Grid Current Modulator  
by Clyde R. Keith

The Neon Stroboscope  
by Edmund Woodard  
(In November Issue)

See Page 66



# Synchronous Motors for Television

In addition to building reliable and satisfactory motor generators, "Esco" has had many years of experience in building electric motors for a great variety of applications.

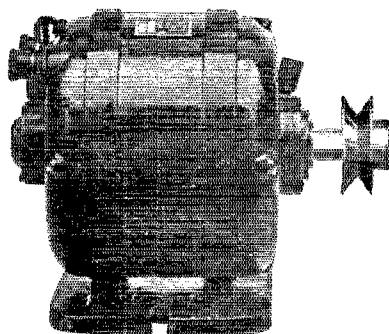

**Synchronous motors**, small, compact, reliable self starting are now offered for **Television** equipment. They require no direct current for excitation, are quiet running and fully guaranteed.

Other types of motors suitable for Television may also be supplied.

Write us about your requirements.

## ELECTRIC SPECIALTY CO.

25 South St.

Trade "ESCO" Mark

Stamford, Conn

## YOU Can Be An Expert RADIO OPERATOR

Used  
By  
U. S.  
Navy



Any one can learn the code quickly and easily at home with the

### TELEPLEX CODE SENDER

Reproduces a actual sending of expert operators. Sends messages, radiograms, etc. —regular code traffic anywhere, any time, any speed.

Code lessons recorded on strong, waxed-tape records make everything simple and clear.

Complete set of tapes FREE.

Used by hundreds of beginners and advanced

students for home practice. Endorsed by U.S. Navy and leading Technical and Telegraph Schools.

Write for  
FREE Literature  
TELEPLEX CO., Dept. RL, 76 Cortlandt St., New York

# Test these tubes today!

SET dials—replace old tubes with Arcturus A-C Long Life Tubes. Notice immediately increased volume.

In addition, these tubes are immune to line surge—have a longer life—in many cases over 5,000 hours.

Complete line of Arcturus Low Voltage Tubes—126H, 126, 071, 127 and 180. "Get Action With Arcturus Tubes—Quicker, Better."

# ARCTURUS A-C LONG LIFE TUBES

Arcturus Radio Company  
220 Elizabeth Ave.  
Newark, N. J.

New United States Aviators leather Crash helmets with headphones and microphones, price \$5.00. Holtzer Cabot Telephone harness, consists of breastplate microphone and double 80 ohm headset with metal headband, microphone is of the Utah type for \$2.50. Kolster Decrometer & Wavemeter: Maker Nil. Elec. Supply Co., type ON 12, range 100-3500 meters complete with graphs, coils, etc., condition is O. K., for \$50.00. Largest stock of Government Radio Transmitting and Receiving material in U. S. Send  $\$2$  stamp for our new and latest reduced price list. Ship anywhere. WEIL'S CURIOSITY SHOP, 20 South 2nd St., Philadelphia, Pa.

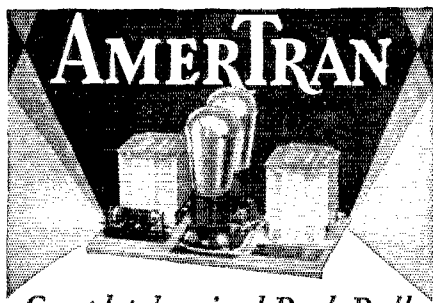

**AmerTran**  
*Completely wired Push-Pull  
 Power Stage*

**H**ANDLES ample power to faithfully reproduce full frequency range without tube overloading. Eliminates hum caused by raw AC on filaments of Power Tubes. Increases clarity, reality and volume.

AmerTran gives you a unit in 4 types designed for practically any combination of speakers [including the new dynamic types], and power tubes. For complete information see any authorized AmerTran dealer or write to us direct, mentioning the speaker and tubes you intend using.

*Price completely wired and ready to install in set \$36.00 without tubes.*

Licensed under Patents owned or controlled by R. C. A. and may be bought with tubes

**AMERICAN TRANSFORMER COMPANY**

*Transformer Builders for more than 20 Years  
 197 Emmet Street, Newark, N. J.*

The short core legs may be held tightly together by driving them into a square insulating tube. The bakelite flanges should be supported from the core and channels by strips of 1/2" bakelite, which should also be used between pies to decrease the distributed capacity.

The dimensions of the core are the writer's idea of a reasonable compromise between the various factors mentioned. One way of minimizing the distributed capacity would have been to make the magnetic circuit 300 feet long, in which case the required number of turns could have been wound on in one layer. For obvious reasons this could not and would not be done, but some designers may prefer to go further in this direction than this writer did.

When the size and weight of a choke built along the lines laid down above is compared with the size and weight of the choke found in the average station of any given power it is apparent that either (a) this method of design is incorrect, or (b) that many stations need new Heising chokes.

The writer wishes to acknowledge his indebtedness to Dr. John F. H. Douglas of Marquette University for his guiding hand in this work.

**Financial Statement**

**B**Y order of the Board of Directors, the following statement of the income and disbursements of the American Radio Relay League for the third quarter of 1928 is published for the information of the membership.

K. B. WARNER, Secretary.

**STATEMENT OF REVENUE AND EXPENSES FOR  
 THE THREE MONTHS ENDED  
 SEPTEMBER 30, 1928**

**REVENUE**

Advertising sales, QST .....	\$17,180.85	
Newsdealer sales, QST .....	11,528.95	
Handbook sales .....	3,019.74	
Dues and subscriptions .....	7,848.19	
Back numbers, etc. ....	322.28	
Emblems .....	164.84	
Interest earned .....	452.29	
Cash discount earned .....	218.48	\$40,680.12

**Deduct:**

Returns and allowances .....	3,670.89	
Provision for newsstand returns .....	650.06	
Discount 2% for cash .....	264.28	
Exchange and collection charges .....	18.88	4,498.58

**Net Revenue .....** **36,181.59**

**EXPENSES**

Publication expenses, QST .....	12,378.98
Publication expenses, Handbook .....	1,568.86
Salaries .....	18,948.65
Forwarding expenses .....	706.64
Telephone, telegraph and postage .....	1,814.91
Office supplies and general expenses .....	1,122.39
Rent, light and heat .....	896.20
Traveling expenses .....	1,389.18
Depreciation of furniture and equipment .....	521.00
Bad debts written off .....	26.00
Communications Dept. field and station expenses .....	95.88

**Total Expenses .....** **38,964.16**

**Net Gain from Operations. .** **\$ 3,217.43**

**Martin's Latest and Greatest Bug**

**THE Great New VIBROPLEX**

Reg. Trade Mark: Vibroplex, Bug, Lightning Bug

**No. 6**



Japanned Base \$17  
 Nickel-Plated \$19

The smoothest, easiest-working bug on the market. Not too fast, not too slow—but just right. Works where others can't.

**Famous Improved Vibroplex**

Used by tens of thousands of operators because of its ease and perfection of sending.



Japanned Base \$17  
 Nickel-Plated \$19

**Special Radio Bug**

Equipped with Extra Large, Heavy, Specially Constructed Contact Points for direct use without relay **\$25**

Be sure you get the Genuine Vibroplex. The Vibroplex Nameplate is your protection. Remit by Money Order or registered mail.

**THE VIBROPLEX CO., Inc.** 325 Broadway New York City

Cable Address: "VIBROPLEX" New York

# Build this modern amplifier at low cost!

Now! Sangamo Transformers at a new low price. And push-pull transformers to match new power tubes and dynamic loud speakers.

A small expenditure and you can have one of these modern amplifiers with plenty of capacity to handle the low notes. Nothing equals the full toned beauty of an amplifier built according to the diagram shown at right.

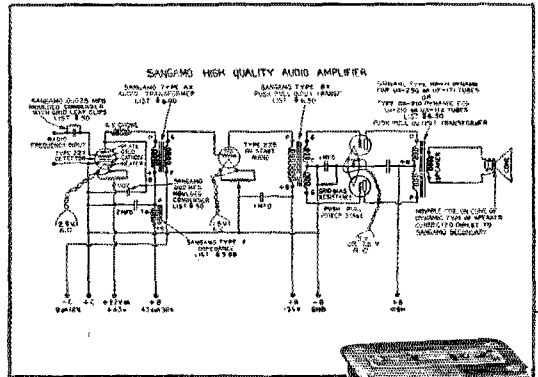

Write for descriptive circulars.

**SANGAMO ELECTRIC CO.**  
Springfield, Illinois

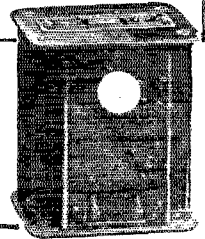

## Mass. Radio School

Est. 1905

Earn \$35 to \$50 Per Week

The rapid expansion of RADIO has created many new positions on land and sea. Openings in Airways, Intercity Radio, Photophone and Television as well as Merchant Marine, Broadcasting, Radio Service and Repair Work. We specialize in training for service with the Radio Corporation of America.

Only school in N. E. conducting Radio, Morse Telegraph and Radio Service and Installation Classes.

We graduate and place in good positions more first class radio operators than any other New England Radio School.

Enroll Now. New term begins Nov. 5. Both Day and Night Classes. Send for Catalogue.

18 BOYLSTON ST. Tel. Han. 8184 BOSTO

## Control the Power!

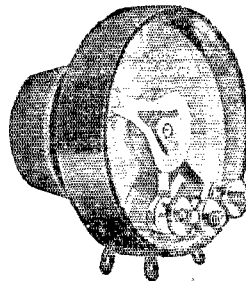

The Centralab Radiohm is used as a volume control, "B" voltage control; in fact, everywhere that a smooth, noiseless variable resistance of this kind is needed.

**Its exclusive features are:**

Rocking Disc Contact.

One turn of knob gives complete variation.

**Centralab Radiohm**  
in following resistances:  
0-2,000 ohms, 0-50,000 ohms,  
0-100,000 ohms, 0-200,000 ohms, 0-500,000 ohms. List Price ..... \$2.00

Insulated shaft and bushing.

Constant resistance.

Noiseless, smooth and easy adjustment.

Rigidly built; fully guaranteed.

Send for booklet of picture and wiring diagrams—"Volume and Voltage Controls—Their Use". It is free.

**CENTRAL RADIO LABORATORIES**

**Centralab**

18 Keefe Avenue

Milwaukee, Wis.

### QUARTZ OSCILLATING CRYSTALS

Unconditionally Guaranteed

1 in. sections ground to 1% of your specified frequency at these prices:

75-100 meters .....	17.50
100-200 meters .....	19.00
300-600 meters .....	18.00
Tested blanks, 2 to 5 mm thick ..	5.00

Gettings of any practicable dimensions made to order.

Prompt Delivery

J. T. Reoney, E. Sc., 4 Calumet Bldg., Buffalo, N. Y.  
"Ten years crystallographic experience"

# Potter Condensers



**Quality  
Long Life  
Uniformity  
Economy**

USED in the finest radio receiver to insure

the operation and make a real musical instrument.

Potter T-2900 Condenser Block for single 250 type tube amplifier—\$20.00.

Potter T-2950 Condenser Block for the push-pull 250 type tube amplifier—\$22.50.

Potter T-2098 Condenser Block for the single 110 type tube amplifier—\$20.00.

Potter T-280-171 Condenser Block for a power pack with 280 type tube rectifier for a 171 type tube power tube—\$18.00.

Potter by-pass and filter condensers are available in all capacities and working voltages.

## The Potter Co.

North Chicago, Illinois

A National Organization at Your Service

## Push-Pull Transmitters

(Continued from Page 16)

In construction, the use of heavy and short conductors in the tank circuit should be rigorously practiced as described in the recent *QST* descriptions of the High-C transmitters. Leads from the respective grid and plate tube terminals to the oscillatory circuit should be symmetrically arranged as to length and position so as not to unbalance the circuit. The antenna coil is split in two sections. Each section is located at opposite ends of the tank circuit inductance and connected in series. The antenna series tuning condenser may be connected in this jumper connecting the two halves of the antenna coil as this arrangement preserves the symmetry of the whole transmitter layout. More advantageous circuit modifications and arrangements of apparatus will suggest themselves to the individual experimenter and the transmitter described here should by no means be taken as the "last word".

Figure 4 is the circuit diagram of a push-pull, crystal-controlled rig using the screen-grid UX-360 tubes in the amplifier. The operation is described on page 11 of *QST* for July, 1928. The only critical adjustment is that of the control grid bias on the amplifier tubes when the amplifier is being used as a frequency doubler. Due to the poor harmonic generating property of the push-pull oscillator, the usual method of picking off the second harmonic output of the oscillator to supply the grid excitation of the frequency doubling amplifier cannot be used. Instead, the grid bias on the amplifier is so adjusted that the amplifier tubes draw plate current only when the exciting voltage from the oscillator is near the peak of its positive half cycle. The amplifier tank is tuned to double the frequency of the oscillator, and will be given a jolt every other positive half cycle of the frequency to which it is tuned and so maintained in an oscillating condition. In contrast with the usual method of exciting the amplifier by means of the second harmonic output of the oscillator, the frequency doubling is actually all done in the amplifier itself, and the amplifier tubes are so biased as to be operating on the bend of their characteristic curve or as distortion amplifiers. In practice, the oscillator should be put in operation and the amplifier tank tuned to approximately double the oscillator frequency. The grid bias on the amplifiers should then be adjusted by varying the grid resistance until the output on the desired frequency is a maximum. With proper adjustment, very high efficiencies are claimed for this system of doubling.

The circuit diagram of the amplifier using the usual three-element tubes, and neutralized, will be found on pages 12 of

5. This system is extensively used at the Naval Research Laboratory, and was described in *Some Notes on a Visit to the Naval Research Laboratory, QST, July, 1928*. For data on the screen grid UX-360 tube see *The UX-360 QST, September, 1928*.

(Concluded on Page 22)



FANSTEEL

# Balkite Radio

IN CABINETS BY

## Berkey & Gay

FANSTEEL PRODUCTS COMPANY, Inc.

NORTH CHICAGO, ILLINOIS



## Real Satisfaction

Wherever alternating currents are to be measured at commercial frequencies a Jewell Pattern No. 77 portable A. C. voltmeter will be found extremely satisfactory, due to its handy size, efficiency in energy consumption, and accuracy in reading.

The Pattern No. 77 ranges are ample to check the voltages likely to be encountered. The instrument illustrated has a triple range of 0-3-15-150 volts, while other single and double ranges, running to 600 volts, are available.

Accuracy, long life and portability are the predominating characteristics of this instrument. It has a well balanced appearance and its construction is such that it will effectively withstand the rough handling incident to use without impairing its reliability.

Our descriptive circular No. 2009 gives complete ranges and prices. Write for a copy.

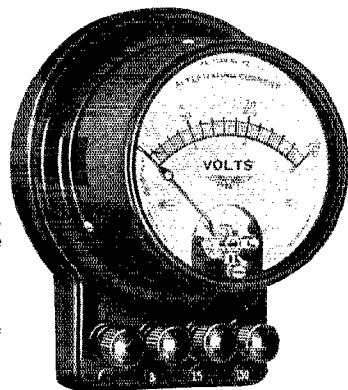

Pattern No. 77  
Triple Range A. C.  
Voltmeter

## Jewell Electrical Instrument Co.

1650 Walnut St., Chicago, Ill.

"28 YEARS MAKING GOOD INSTRUMENTS"

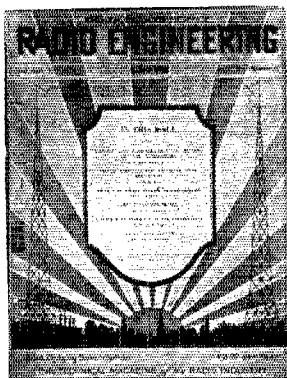

### Grid Circuit Detection Distortion

by J. R. Nelson

### The Industrial Laboratory

by Zeh Bouck

(In December Issue)

See Page 66

## BECOME A RADIO OPERATOR

See the World. Earn a Good Income.  
Duties Light and Fascinating.

### LEARN IN THE SECOND PORT U.S.A.

Radio Inspector located here. New Orleans supplies operators for the various Gulf ports. Most logical location in the U.S.A. to come to for training.

Nearly 100% of radio operators graduating on the Gulf during the past six years trained by Mr. Clemmons, Supervisor of Instruction.

Member of the A.R.R.L.—Call "S G R"  
Day and Night Classes—Enroll anytime—Write for circular.

### GULF RADIO SCHOOL

844 Howard Ave.

New Orleans, La.

## Complete Parts for SILVER-MARSHALL

No. 730

### "Round-the-World" FOUR

A COMPLETE short wave receiver (17.4 to 204 meters) and two-stage audio amplifier. All wave lengths are covered with no dead spots. Amateur bands fall well to center of tuning dial.

### Special Discounts for Amateurs

Also Complete Stock of

Leach Relays—R.E.L. Products—3000-Volt Rectobulbs—Omnigraphs—Vibroplexes—Silver-Marshall Shield Grids.

Send for New 1929 Ham Book—FREE

C H I - R A D  
CHICAGO RADIO  
APPARATUS CO.  
415 S. DEARBORN ST., CHICAGO

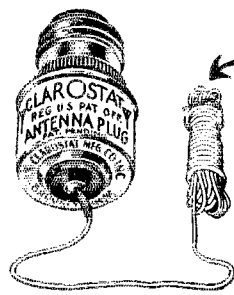

Improved socket antenna plug—correctly engineered, correctly built. New type brass-plate and mica blocking condenser. 10-foot connecting cord. Neat. Compact. Safe. Works anywhere. And only \$1.50!

**For DX RESULTS**

You must have maximum signal pick-up. Don't depend on skimpy antenna. Don't be discouraged by "dead spots." Just use a CLAROSTAT ANTENNA PLUG, alone or as a "booster." You'll be surprised!

Also, use proper grid leak value—from 2 megohms or less for "locals," to 10 megohms for DX. The GRID LEAK CLAROSTAT provides precise values at all times.

And be sure you have correct B and C voltages. Several types of Clarostat will attend to that.

WRITE for literature describing complete line of Clarostats and how to improve your radio results. Or ask your dealer about Clarostat radio helps.

**CLAROSTAT MFG. CO., Inc.**  
285 North 6th St. Brooklyn, N. Y.

**CLAROSTAT**  
REG. U.S. PAT. OFF.

**Calls Heard**

(Continued from Page 50)

w5ml w2ao w6hp fo-lsr fo-a4o fo-a4v fo-a4e fo-a3z fo-a9e fo-a3a ai-2kt ai-2kw af-kol as-9rb as-35ra fq-pm xen-ocp xen-ocq si-lay oa-2bb.

S.S. "Dromore Castle," Union Castle Mail S.S. Co., 28 Broadway, New York City, W. Clyde Townsend, Operator

On South African Coast—Capetown—Beira—Capetown wlaqt wlauk wbea wlbux wlcio wlio wimo wirf w2aie w2apy w2bm w2cuf w2cuz w2exl w2ho w2pd w2rz w2tq w3afj w3anh w3ec w3hf w3mb w3us w4ahm w4hu w5wj w6qv w6avp w6bam w6to w8alu w8bri w8cht w8dp w8duh w8ez w8vx w8ws w8xe w9dck ac-9aa ag-rb14 as-ber as-27fb es-27rb eb-4au eb-4bh eb-4ev ef-lex ef-3cp ef-3eat ef-8gao ef-8gdb ef-8jf ef-8rrr ef-8san ef-8vu g6ku g6wt ei-1fu ek-4au ek-4auk em-sm em-smtc en-ofp en-oga ep-lae es-2nad eu-15ra eu-64ra eu-38ra ewb ewbb ewar fb18a fm-ain fq-pm fq-ocd1 fq-ocya fx-lma oa-3ks od-lir od-pkl op-lcm sa-a82 sa-ca2 sb-law sb-lid sb-3ag sb-32a sc-2ab v9ap xau-2rs xen-ocq xhu-7eff.

6693 to 6000 miles S. E. New York w1afz w1ekj w1cmp w1af w1rp w2aqi w2exl w2ja w3au w8bph w8gt w3lb w4ca w8ank w8bx e6ml ep-3eo nq-7ex

6000 to 5000 miles S. E. New York w1afz w1ajc w1apd w1aqi w1bjx w1ic w2af w2anh w3aws w3gt w4co w4jk w4rl w5afg w5afx w5ajh w8bcu w8dpo w8vx w9ef

4000 to 4000 miles S. E. New York w1atm w1avd w1bqs w1cmf w1ic w1om w1rjp w1xl w1yb w2ach w2af w2ang w2ae w2ash w2baz w2bhr w2cjd w2chu w2com w2fc w2fw w2gj w2fy w3afj w3afu w3awn w3awj w3bph w3chg w3cvc w4ca w4ei w4pf w5ain w5bbc w5bw w5bj w5jx w5kc w5qi w5qx w5ox w5ank w5bec w5bf w5bi w5bl w5bn w5bot w5hog w5box w5kau w5eco w5cas w5cd w5dra w5dvy w5han w5hx w5xn w5cr w5eag w5eaj w5ef w5efe w9fax w9fp w9fr w9zd eb-4ju ee-clj ef-8sm ek-4acq fl-1ab sb-2az sb-7ab su-lci su-2ak

4000 to 3000 miles S. E. New York w1ack w1af w1ard w1bea w1bqs w1caa w1dc w1kc w1om w1yb w2ait w2akv w2alo w2ang w2hxf w2cbk w2auq w2cvf w2exl w2he w2hq w2ja w2lx w2se w2uk w3alq w3anh w3avd w3bms w3ce w3chg w3cj w3ekf w3p w3he w3hi w3ge w3sz w3uv w1adg w1cs w1dt w4ge w4gw w4rt w4ug w4wo w5ail w5ain w5aoz w5fq w5jw w5axz w5bni w5bqy w5cau w5ccs w5eft w5chg w5cke w5cro w5ent w5dem w5dnn w5dqv w5dwe w5eop w5ex w5uk w5abu w5axh w5bza w5cbd w5cib w5ctg w5ecx w5edw w5ef w5ejo w5epa ee-ear66 ei-lax ei-latw ep-1bl ei-lab ve1br sb-lah sb-lbk sb-lbs sb-1cg sb-1cm sb-2ah sb-2ay sb-7ab su-lcx su-2ah

3000 to 2000 miles S. E. New York w1arq w1bea w1bqg w1ba w1ekf w1ekp w1enz w1gc w1qv w1yb w2aam w2ado w2af w2akv w2ang w2anh w2anq w2ayj w2bhr w2bjz w2bpq w2bxu w2chu w2cti w2cp w2hq w2hs w2ja w3afx w3avd w3aws w3ckp w3sz w3tq w4vp w5ajv w5bda w5dsy w5fu eb-4ft ef-8gdz ef-8ku em-sad ep-lca eu-15ra sb-lbf sb-lca su-lfc

2000 to 1000 miles S. E. New York w1ack w1af w1ad w1bv w1bx w1cmx w1om w1rp w1vg w2af w2af w2af w2afa w2axe w2agi w2avp w2ayj w2ba1 w2baz w2blx w2bs w2bxr w2cdq w2atr w2pa w2tp w2uc w2uo w2vq w3aih w3afx w3amb w3bph w3sz w4ah w4arh w4co w4oz w5ain w5fc w5abw w5ads w5ajq w5axg w5aze w5bzc w5bm w5cbq w5eft w5cs w5dnn w5dpo w5uk w5dl w9ahm w9bc w9cya w9ecx w9ejo w9ewl eb-4ra ek-4uo nn-7nic sb-2ah ve1br ve3es.

ec-RP6, Charles Pesek, Prague, Smichov, Sumava, 1429, Czechoslovakia

w1om w8cin ksa sa-de3 sa-a22 sb-1aa sb-1ah sb-1ak sb-lax sb-law sb-lbe sb-lbg sb-lbs sb-1ca sb-1en sb-1id sb-1oa sb-2af sb-2ag sb-2ah sb-2aj sb-2as sb-2az sc-lai sc-2ab sc-2ae sc-3ac sc-3aj su-laa sc-2bt fe-egyz fm-tun2 fm-8rit fq-ocya fo-a3a fo-a3z fo-a4o fo-a7w ai-2kt ai-2kw am-3ab as-35ra oz-3aj ea-cm ea-fl ea-gp ea-htd ea-hz ea-kl ea-la ea-lra ea-pv ea-tv ea-wf eb-4au eb-4ar eb-4as eb-4cc eb-4di eb-4fp eb-4ft eb-4fq eb-4gm eb-4hp eb-4ic eb-4jj eb-4ro eb-4us eb-4uu eb-4vu eb-4yj ee-na2 ee-lab ee-lbz ee-lfm ee-lna ee-lrf ee-lro ee-lrx ee-lyl ee-2ny ee-3pa ee-3sk ee-3wa xec-okl ed-7ag ed-7ak ed-7du ed-7ly ed-7na ed-7nm

**VITROHM** Transmitting Grid Leaks and Rheostats now cover the entire line of transmitting tube circuits. The prices on these amateur products are reduced materially. Your dealer should stock Vitrohm Transmitting Products. If you have difficulty in obtaining them, write us direct.

CATALOGUE NUMBER	PRODUCT	RESISTANCE	DISSIPATION	CURRENT	MAX. TUBE RATING	PRICE
507-2	Grid Leak*	5000 ohms	44 watts	90 m.a.	100 watts	\$2.00
507-3	Grid Leak*	5000 ohms	200 watts	200 m.a.	1000 watts	2.80
507-4	Grid Leak†	50,000 ohms	200 watts	60 m.a.	1000 watts	6.50
507-5	Grid Leak†	20,000 ohms	200 watts	100 m.a.	1000 watts	4.25
507-51	Grid Leak*	10,000 ohms	200 watts	135 m.a.	1000 watts	4.00
507-66	Grid Leak**	15,000 ohms	200 watts	120 m.a.	1000 watts	6.00
507-63	Rheostat†*	50 ohms	50 watts	1 amp.		5.50
507-59	Rheostat*†	20 ohms	80 watts	2 amp.		5.50
507-83	Rheostat*†	12.5 ohms	60 watts	2.2 amp.		5.50

\* Center-tapped

† DeForest P or R. C. A. 852 Tube

De Forest H Tube

\*\* Steps at 5M—10M—15M

for R. C. A. 852 or DeForest P Tube

† For Primary Control

\*† Filament and Primary Control

## Ward Leonard Electric Company

37-41 South Street

Mount Vernon, N. Y.

### MIDGET TELEPLEX CODE SENDER

ONLY \$3.50

Postpaid

Guaranteed

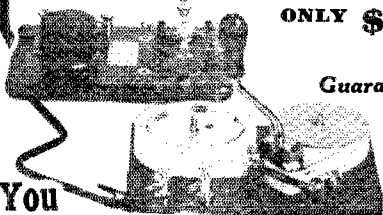

You Can Be An Expert Radio Operator

This amazing instrument teaches you to read code like an expert in half the usual time. Reproduces actual sending of expert operators. Sends you messages, radiograms, etc., anywhere, anytime, any speed. You'll be amazed when you hear it. Just like having an expert operator in your home. Code lessons recorded on strong-waxed-tape records make everything simple and clear. Send only \$3.50 for Midget Teleplex with lessons; or \$5.50 with high-frequency key and buzzer. Satisfaction guaranteed. Money back if not delighted. Don't delay. Send today.

TELEPLEX CO. 74-76 Cortlandt St., New York, N.Y.

### ROBERT S. KRUSE

Consultant for Shortwave Devices

103 Meadowbrook Road,  
West Hartford, Conn.

Telephone Hartford 45327

## Send For WESTERN RADIO New 1929 Catalog

Dealers and Set Builders

THE NEW 1929 Catalog is crammed full of the FINEST, NEWEST, Nationally known A.C. sets, consoles, cabinets, dynamic speakers, kits, PARTS, eliminators and accessories at LOWEST PRICES. Largest stock of radio parts. Prompt delivery.

Write for our FREE catalog  
WESTERN RADIO MFG. CO.,  
128 W. Lake St., Dept. Q12, Chicago

\*\*\*  
**FREE**  
\*\*\*



## The Big Friendly Radio House

# There is no better recommendation

than to have the outstanding leaders of an industry continue to buy your product in ever increasing quantities for use with their own manufactures.

Hardwick, Field, Inc., points with pride to the list of those (given in part below) who are now using Har-field Resistors. There could be no better recommendation.

- |                                      |  |
|--------------------------------------|--|
| Western Union Telegraph Company      | Stromberg-Karison Tel. Manufacturing Company |
| A. H. Grebe & Company                | Kolster Radio Corporation                    |
| Splifford Electric Co.               | American Transformer Co.                     |
| Magnavox Corporation                 | Faunsteel Products Co.                       |
| Samson Electric Co.                  | Martin Copeland Co.                          |
| Philadelphia Storage Battery Company | Zenith Radio Corporation                     |
|                                      | Crosley Radio Corporation                    |

Tell us about the resistor you want. If we can't supply you from our standard range of sizes, we shall be glad to make up samples for you with prices. Write to

## HARDWICK, FIELD, INC.

SALES OFFICE  
122 Greenwich St.  
New York



FACTORY  
215 Emmet St.  
Newark, N. J.

ed-7md ed-7sp ee-ear6, ee-ear-c7 ef-1m ef-8gr ef-8bak ef-8be ef-8big ef-8bl ef-8br1 ef-8cbh ef-8cfo ef-8dmb ef-8en ef-8eo ef-8eat ef-8flm ef-8gdb ef-8gou ef-8grg ef-8hip ef-8jb ef-8jc ef-8jcb ef-8jv ef-8kv ef-8lb ef-8limh ef-8lt ef-8met ef-8mmq ef-8msm ef-8mat ef-8orm ef-8pbl ef-8pns ef-8pac ef-8rbv ef-8erm ef-8rko ef-8rit ef-8rnf ef-8rpu ef-8rrm ef-8sac ef-8sot ef-8swy ef-8vb ef-8vcd ef-8vx ef-8zo g2ax g2mf g2nm g5is g5lb g5lf g5wq g5bb g5iy g5nz g5pa g5rc g5rm g5am g5ub ei-lax ei-lis ei-lid ei-lid1 ei-lid2 ei-lid3 ei-lid4 ei-lid5 ei-lid6 ei-lid7 ei-lid8 ei-lid9 ei-lid10 ei-lid11 ei-lid12 ei-lid13 ei-lid14 ei-lid15 ei-lid16 ei-lid17 ei-lid18 ei-lid19 ei-lid20 ei-lid21 ei-lid22 ei-lid23 ei-lid24 ei-lid25 ei-lid26 ei-lid27 ei-lid28 ei-lid29 ei-lid30 ei-lid31 ei-lid32 ei-lid33 ei-lid34 ei-lid35 ei-lid36 ei-lid37 ei-lid38 ei-lid39 ei-lid40 ei-lid41 ei-lid42 ei-lid43 ei-lid44 ei-lid45 ei-lid46 ei-lid47 ei-lid48 ei-lid49 ei-lid50 ei-lid51 ei-lid52 ei-lid53 ei-lid54 ei-lid55 ei-lid56 ei-lid57 ei-lid58 ei-lid59 ei-lid60 ei-lid61 ei-lid62 ei-lid63 ei-lid64 ei-lid65 ei-lid66 ei-lid67 ei-lid68 ei-lid69 ei-lid70 ei-lid71 ei-lid72 ei-lid73 ei-lid74 ei-lid75 ei-lid76 ei-lid77 ei-lid78 ei-lid79 ei-lid80 ei-lid81 ei-lid82 ei-lid83 ei-lid84 ei-lid85 ei-lid86 ei-lid87 ei-lid88 ei-lid89 ei-lid90 ei-lid91 ei-lid92 ei-lid93 ei-lid94 ei-lid95 ei-lid96 ei-lid97 ei-lid98 ei-lid99 ei-lid100

cc-RP19, Alois Weirauch, Mestec Kralove 9, Czechoslovakia

wicmp wlic wliw wliw wlic w2af w2apv w2aqi w2kr af-kol fm-ocup fz-4shpg fz-qpm nq-2ac nr-gc oa-5hg oz-2go oz-8az sb-1ba su-lci  
20-meter band  
w1ab w1aq w1atr w1blv w1byv w1df w1mo w1mw w1sz w2ap w2arb w2avq w2awq w2azo w2kx w2mb w2md w2ra w3adm w4bd w4js w4nh w5ail w5axa w5bcu tm-8ev.

### ec-2YD

20-meter band  
aq-lac a2-1mdz fe-1ea fe-egex fk-1lm fk-4ms fm-8kf fm-8rit fm-tun2 fq-8hpz k4kd wlap wlrp w1asf w1byv w1eq w1eat w2ra w2ch w2co w2hm w2bug w2amd w2bgt w3ke w3adm w3ath w3azk w4js ve2bg ve3he sa-dq4 sa-dt9 sb-1aw sb-2ab sb-2ig sb-3qa sc-8ac sc-8aj oa-2bb oa-5hg zen-ocp

### 30-meter band

ag-rb14 ar-rb5 ac-9aa ac-9ab as-15rw aj-4gz aj-4za au-rabs fm-8jo fm-8gke fm-ocup fo-6u ep-8am fq-pm fq-8hpg fq-ocya ne-8rg wibux w2ats w4pf ux-1xl sa-de8 sa-dh3 sa-dq4 sa-ma9 sa-f12 sa-bai sb-1ah sb-1aw sb-1bo sb-1be sb-1ba sb-1bs sb-1bm sb-1ca sb-1eo sb-1cm sb-1ic sb-1ic sb-1ih sb-1id sb-1fd sb-2ae sb-2ad sb-2ih sb-2al sb-2ay sb-2ay sb-2ax sb-2ab sb-8ag sb-8qa sb-8ag ac-1ah ac-1ai ac-2ab ac-8ah sg-a5 sg-a7 sg-bl sg-1oa su-lbx su-lci su-lbv su-lcv su-lcg su-2ak su-3ah oa-2ns oa-8my oa-8kr oa-8gr oa-8yx oa-8vp oa-5hg oa-5ja oa-5mb oa-5by oa-5gr oa-7by oa-7ch oa-2ga oz-2go oz-2be oz-2bg zen-ocp zeu-48ra xep-1ma.

### ef-8XD

37-meter band  
w1aba w1adb w1adm w1afb w1arg w1arb w1art w1asd w1asv w1asp w1aue w1axx w1bnm w1bux w1cak w1cuz w1euf w1eh w1kc w1ku w1ry w1xl w2aad w2aau w2afr w2afo w2aib w2aku w2ang w2apv w2aqi w2atr w2as w2baz w2bda w2bfo w2bjr w2blx w2bmj w2coq w2cou w2cyy w2fd w2hc w2kj w2jd w2ke w2uc w2afu w2afx w2age w2ahh w2aic w2aif w2ag w2akw w2ard w2aqm w2awd w2aws w2bav w2bq w2bqv w2cc w2cdl w2ckl w2lw w2mw w2ua

## Neutralization Means— More Power From Any Set

Science has proven that neutralization is the only satisfactory method of controlling oscillation in a Tuned Radio Frequency Circuit and that it increases the actual power per stage of amplification 15 to 300%.

The Neurodyne principle can be applied to practically every set by the simple installation of X-L Vario-densers. The result is an amazing increase in the efficiency and power of the receiver. Send for interesting book of circuits and picture diagrams showing the use of the Vario-denser.

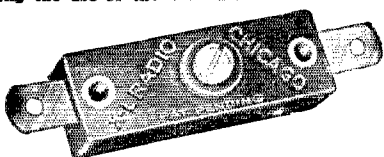

MODEL "N" VARIO-DENSER

Has variable capacity, adjustable from 1.5 to 20 micro-microfarads, which is .0000018 to .00002 microfarads. Price each \$1.00.

X-L RADIO LABORATORIES  
Dept. D 1224 Belmont Ave., Chicago, Ill.

## JACOBS ANTENNA SPREADER

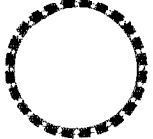

Made in Both 5 in. and 7 in. diameter  
Patented Sept. 8, 1926; Sept. 7, 1926  
Used whenever and wherever rapid and efficient 4, 6 or 8 wire cage antenna or counterpoise construction is required. Price \$5.00 per dozen; \$3.25 for a half dozen.  
CHARLES F. JACOBS, (WZEM)  
279 Park Place, Brooklyn, N. Y.

Off the Press September 1

# "RADIO THEORY and OPERATING"

By Mary Texanna Loomis  
Lecturer on radio, Loomis Radio College; Member Institute of Radio Engineers.  
992 pages; 300 illustrations. Thoroughly revised; right down to date; contains new "Q" signals and laws and regulations for 1929. Used by hundreds of colleges and all Government radio schools. Sale by bookdealers, or sent, postage paid, on receipt of \$3.50 check or money order.  
LOOMIS PUBLISHING CO., Dept 5, Washington, D. C.



# SPEEDS UP TRAFFIC!!!

# ELIMINATES QTA!!!

## Rayfoto Automatic Recorder

Prints "sigs" for permanent record

Transmits and receives photographs

Measures A. C. Component

Transmits and receives facsimile messages, also

### AN IDEAL FREQUENCY INDICATOR

Hook-up  
With  
Unit

**SPECIAL OFFER**  
to QST READERS

Price  
**\$25.00**

## RADIOVISION CORPORATION

62 WEST 39th STREET

NEW YORK, N. Y.

### RADIO OPERATORS WANTED

THE EASTERN RADIO INSTITUTE can train you quickly and thoroughly because:

**MODERN AND EFFICIENT METHODS**  
THOROUGH INSTRUCTION under staff of  
**LICENSED COMMERCIAL OPERATORS**  
**MODERN APPARATUS** including SHORT WAVE  
TRANSMITTER

FIFTEEN years a RADIO SCHOOL  
THE OLDEST, LARGEST and MOST SUCCESSFUL  
school in New England. RECOMMENDED BY THE  
A. R. E. L.

Day or Evening Classes Start Every Monday.

**SPECIAL CODE CLASSES**

Write for Illustrated Prospectus

**EASTERN RADIO INSTITUTE**

899 BOYLSTON STREET BOSTON, MASS.

### BUGS

New, high-class instruments. Priced \$11 to \$17. Money back guarantee.

### DC RELAYS

Break-in and Single contact styles. High and Low voltages \$20.

ELECTRO MANUFACTURING CO.,

443 Stevenson St., San Francisco, Cal.

### TRANSFORMERS

Guaranteed—Mounted—Complete

250 watt 550—700 each side ..... \$10.50  
700 watt 1000—1500 each side ..... 14.50  
700 watt 500-cycle 800-1200-2000 each side ..... 15.00

Chokes, Polyphase and 25-cycle Transformers  
Add \$2.00 for fil. winding

OCES F. GREBEN

1927 So. Peoria Street, Pilsen Sta., Chicago, Illinois



Choose from the Year's Most Successful designs—practical helps for amateur and professional Builders.



Here are described—and illustrated—in understandable, interesting terms, the newest designs in A C Power Amplifiers. Every single one has been proved practical. This authentic A C Manual is the work of Merle Duston, well-known engineer and the author of many radio text books. Mr. Duston has condensed in this valuable volume the best efforts of the industry covering the past year of Radio's greatest development.

A limited supply of this splendid A C Manual is available through the Dongan Laboratories. Send 20 cents for a copy to be mailed to you.

**Dongan Electric Manufacturing Co.**

2999-3001 Franklin St., Detroit, Mich.

TRANSFORMERS of MERIT for FIFTEEN YEARS

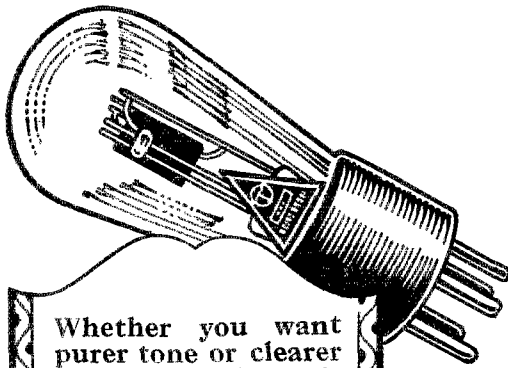

Whether you want purer tone or clearer D.X. you will get it with Quality Televocals. All standard types. Ask for them at your dealers.

**TELEVOCAL CORPORATION**  
Televocals Building  
Dept. R-6, 588 12th Street  
West New York, N. J.

# Televocals

## Quality Tubes

THE PRICE GOES UP!

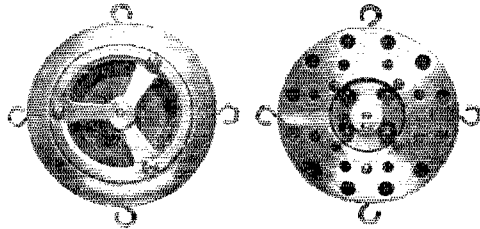

Dec. 15th the price of our now famous two button stretched diaphragm microphone goes to \$67.50. Until then the price is \$40.00.

Hundreds of users are enthusiastic boosters. Recently marked improvements have made it still better, but necessitate a higher price. We positively guarantee it against any other!

Broadcasters, amateurs, public address systems, theatres, etc.—write, wire, telephone—**AT ONCE!**

**E. F. JOHNSON COMPANY**

Waseca, Minn.

## SET Builders

Barawik, the first and oldest radio specialty house, offers you unusual service this year. Bigger stocks, quicker shipments, lower prices. Deal with an old established, reliable house. Get honest goods, honest service, honest prices. Barawik service makes you more money. Send now for big new catalog—showing lowest wholesale prices on sets, parts, short wave, etc.

**BARAWIK CO.** 1112 CAVAL ST., CHICAGO, U. S. A.



w8sn w4aba w1abr w4aby w4abl w4acn w4acr w4afa w4afc w4ahy w4aou w4bb w4bl w4js w4oc w4nu w4qs w5bez w5je xnu-6clv w8adg w8aht w8apd w8bbg w8bbl w8bhi w8bjb w8bm w8box w8bpl w8brh w8brl w8bth w8ces w8cft w8cfr w8ciw w8cke w8cvg w8dcc w8dcm w8drj w8duw w8kx w9arl w9aah w9be w9bfc w9cee w9cnm w9efw w9eln w9ekx w9epa w9fax w9tqn w9fs.

20-meter band

w1alb w1arq w1bey w1bcw w1bhs w1bkf w1byv w1cei w1ckb w1cmf w1dvw w1ka w1mo w1rpl w1ry w2aer w2af w2alw w2amq w2apl w2arb w2ary w2avz w2blv w2cuq w2fp w2mb w2md w2nm w2ow w2rs w3adm w3awq w3bph w3gi w3hr w4wm w6wb w6zdz w7acc w8aac w8all w8asf w8avb w8bcu w9bdt w8bgx w8bzl w8cew w9ejm w8enz w8dkt w8dog w9adn w9axf w9ben w9bqy w9bzz w9crr w9cuw w9cap w9ajo w9alj w9eln w9ell w9fci w9fof w9mt v8aac v8bhe v2ba v2ca v2rg v28m nj-2pa nx-8rg nu-7ni np-4an nq-2sf nq-5ni nr-4ac nt-2fp nx-1kl

## Relieving the Glass Arm

(Continued from Page 73)

There seems to be a tendency on the part of many beginners to divide some character combinations, thus making others. This is especially noticeable in the first few attempts at sending the letter C, when the inexperienced man will, in nearly every case, send NN, making a division in the middle of the letter. The letters Q and Y also seem to offer some difficulty on the first few attempts to form them. The sooner such misleading tendencies are corrected, the more rapid will be the advancement in the succeeding stages of practice. The practice of sending the telegraph code may be compared to practice on the typewriter insofar as errors are concerned. During the learning period, errors once made recur with exasperating regularity unless they are corrected immediately upon being detected.

The element of accuracy cannot be too strongly emphasized. Accuracy must be acquired before speed is attempted, for of what value is a group of characters sent at any speed if they are unintelligible to the receiving operator? It is unreasonable to expect that any other than poor sending form would be the result of careless and haphazard practice procedure. By all means strive first for accuracy, and speed will come in due time. Remember that speed, while very desirable, and indicative of a well-trained and efficient operator, is a secondary consideration. Accuracy first.

## Push-Pull Transmitters

(Continued from Page 28)

QST for July, 1928, and 31 of QST for November, 1928. Push-pull circuits have appeared in QST long prior to this year, however, Meissner and Hartley circuits being described in November, 1924, and mention made of the subject before that. There's really not so much new in this game.

The intention is not to create the impression that all transmitters should necessarily be converted to the push-pull type, but it is particularly recommended that those transmitters in which two tubes are being used in parallel may be converted to the push-pull circuit in one form or another to good advantage.



# UNI-RECTRON POWER AMPLIFIER



(IDEAL FOR USE WITH DYNAMIC SPEAKERS)

As the Uni-Rectron stands it is a super power amplifier, which can be used in connection with any radio set and loud speaker. Binding posts are provided for input to the Uni-Rectron and output to the speaker. Requires no batteries for its operation. It obtains its power from the 110 Volt, 60 Cycle alternating current lighting circuit of your house.

## MODEL AP-935

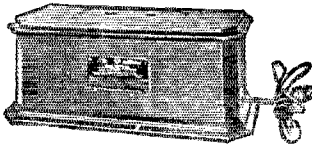

whisper to the loudest crash of sound—E.C.A. Uni-Rectron amplifies each note at its true value. High and low notes are all treated alike.

The volume and quality delivered will be a revelation.

Also by removing the input and output transformers it can be used as a source of power for an oscillating or transmitting tube, furnishing power for all circuits, grid, plate and filament and is the cheapest form of Power Supply for Amateur Transmitting purposes ever offered. New.

LIST PRICE \$88.50  
(without tubes)

Special \$19.75 EA.

The UX-210 super power amplifying tube and the UX-216B or 281 rectifying tube are used with this amplifier, which cannot overload. From the faintest

## AMERICAN SALES CO.

19-21 Warren St.,

New York City



## Junior Rheostats

Small in size, but a master instrument. Ask your dealer to show you the exceedingly fine adjustment and velvet smooth action. Diameter, 1 7/16 inches. Up to 400 ohms .....75c  
1000 and 2000 ohms .....\$1.00  
Self-attaching, positive acting switches for Junior Rheostats .....40c

### RESISTANCE UNITS

Here is where you need absolute dependability and you get it with Yaxley Resistance Units. Run true to rating. Convenient screw eye and soldering lug terminals for easy mounting. Filament and grid type; one to 8000 ohms .....15c to 40c  
YAXLEY MFG. CO. Dept. S, 9 So. Clinton St., Chicago

## DODGE RADIO SHORTKUT

With Appendix and Hints for Better Key Work. Fixes Signals in mind to stick—Kills Hesitation, Cultivates Speed and Good Fit—Produces Results. Slow Hams raise speed to 25 per in few evenings. Previous Failures qualify and pass exam quickly. Beginners master code and pass in ten days.

### DODGE HIGH SPEED METHOD

(Intensive Speed Practice)

Quickly puts 25 per Hams in 25-40 per class. Five Hams report made this gain in few evenings. One of them by 75 minutes total practice only.

### DODGE MORSE SHORTKUT

Easily mastered by Radio Ops—Kills tendency to mixup or confusion. Either code used as desired.

### REPORTS FROM USERS

Tell the complete story—Mail on request. Radio \$3.50. High Speed \$2.50. Morse \$2.50. Money order. None C. O. D. Foreign add 50 cents. See our Hamad.  
C. K. DODGE, MAMARONECK, NEW YORK.

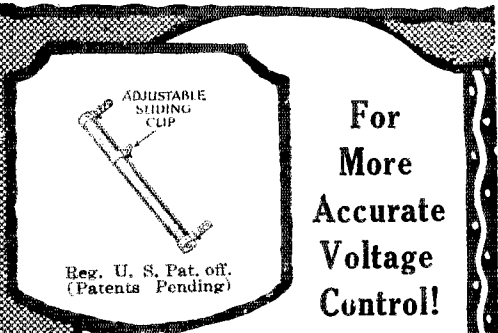

For  
More  
Accurate  
Voltage  
Control!

Reg. U. S. Pat. off.  
(Patents Pending)

## TRUVOLT ALL WIRE RESISTANCES

The ingenious method of winding a much greater quantity of larger resistance wire of comparatively low resistance into a small space assures a finer regulation of voltage and far greater current-carrying capacity.  
Truvolt Variables simplify B-Eliminator construction by eliminating difficult calculation and making all adjustments easy. 22 stock sizes \$3.50 each.  
Truvolt Fixed Resistances are adjustable to different set values by the use of sliding clip taps—an exclusive Truvolt feature! Made in all desirable values and circuit ratings.  
Electrad specializes in a full line of Controls for all Radio Purposes including Television. Write for Free Circulars and Full Information.  
Dept. T-12, 175 Varick Street, New York



## THE ONE AND ONLY

rectifier that meets 1929 requirements—the Mercury Arc. Read your ham bible, page 28 Sept. issue. Are you going into the new year handicapped by an antiquated plate supply? No!! Be proud of your station—don't be a combination bartender and nursemaid—get an Arc and operate—your rectifier problems solved.

RECTIFIER ENGINEERING SERVICE

4837 ROCKWOOD RD., RADIO 8ML

CLEVELAND, OHIO

Say You Saw It In QST—It Identifies You and Helps QST

# Raytheon Kino-Lamp

## Developments in TELEVISION

For many months Raytheon Laboratories have been developing numerous types and styles of Kino-Lamps, which provide suitable light sources and light sensitive relays for all systems. Among these are various types of spot glow lamps as well as flat plate type—all of which can be made to glow in white, blue, green, and various shades of orange.

Development of Foto-Cells has also progressed rapidly, so that cells can be made which will respond to various frequencies in the light spectrum.

KINO-LAMP for receiving, List Price \$7.50  
FOTO-CELL—for sending—prices and information upon application.

RAYTHEON MFG. CO.  
Kendall Sq. Bldg., Cambridge, Mass.

# Raytheon Foto-Cell

## GENUINE Nathaniel BALDWIN Regular \$9.00 Famous Type C HEADPHONES



We offer several thousand genuine Nathaniel Baldwin Perfect Type C headphones fresh from the factory in original sealed cartons at a fraction of their cost. Never before sold for less than \$9. Price while they last only \$5.50. Satisfaction guaranteed or money refunded.

**BALDWIN HEADPHONES**  
hold all long distance records, you simply cannot get distance by any other means. An operator at San Francisco picked up a code message from Bagdad, Turkey, half way around the globe, a world's record. Whether you are a professional operator, amateur, experimenter, set builder or R. C. L., these are the headphones you need.

PREMIER ELECTRIC CO.  
150 Nassau St., New York

OUR  
PRICE  
\$5.50  
ORDER  
NOW

# AEROVOX

Makers of high quality resistors and condensers that are Built Better — to endure.  
Write for The Research Worker.  
A free monthly publication.  
AEROVOX WIRELESS CORPORATION  
68 Washington Street, Brooklyn, N. Y.

## Some Election Returns

NOVEMBER every year is election month in seven A.R.R.L. divisions. This year balloting is now going on in the Central and New England Divisions to choose the director for 1929-1930. In the remaining divisions a single eligible candidate has been declared elected, by action of the Executive Committee, so that there is no balloting by the membership in these cases.

In the Roanoke and Rocky Mountain Divisions, Messrs. Gravely and Segal respectively were the only candidates and so have been declared reelected. In the West Gulf, Mr. Holmes H. Green was named but withdrew in favor of Mr. Corlett, the incumbent, who was also nominated, and so Mr. Corlett also succeeds himself for the coming two years. In the Hudson, Dr. Dunn, the present director, and Dr. A. L. Walsh, W2BW, were named, but Dr. Dunn decided not to stand for reelection and withdrew his name. There being then but one candidate, there was no balloting and Dr. Walsh has been declared the new director, taking office the first of the year. In the Northwestern there were no nominations, as a result of which Mr. Weingarten, the incumbent, continues in office. Results in the Central and New England will be announced in our next issue.

—K. B. W.

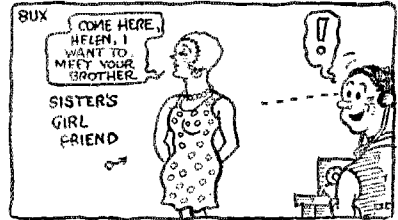

## PACENT DUO-LATERAL COILS

FOR laboratories, experimenters, engineers and for special circuits, Pacent Duo-Lateral Coils are the accepted standard.

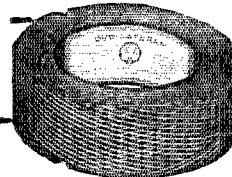

A complete line of all standard turn ratios are always in stock.

Write for information and prices

Pacent Electric Co., Inc.  
91 Seventh Avenue, New York

## — LAST MINUTE SPECIALS —

JEWELL—High Resistance Voltmeters 0-250V, D.C. (8 readings) list \$22.....	Our Price	\$4.75 ea.
Genuine Black Bakelite Panels 33" x 43", 3/16" thick. Reg. Price \$29.....	"	8.75 "
U. S. ARMY Aeroplane Spark Transmitters, Gov. cost \$47 each.....	"	4.75 "
G. E. Kenotron Rectifying Tubes (Type T.B.1).....	"	1.25 "
Gould Kathanode Inopower, Automatic Radio "A" Power (6 volt), list \$39.....	"	13.75 "
2 Henry—250 Mill Choke Coils, D.C. Resistance 20 ohms List \$25.....	"	7.50 "

AMERICAN SALES CO., 19-21 WARREN ST., NEW YORK CITY

# Q S T OSCILLATING CRYSTALS

NOTICE—New Prices Effective November 1st, 1928

### AMATEUR BANDS.

Prices for grinding crystals for use in the various amateur bands are as follows:

1715 to 2000 Kilo-cycle band.....	\$26.00
3500 to 4000 Kilo-cycle band.....	\$27.50
7000 to 7800 Kilo-cycle band.....	\$45.00

The above prices are for grinding a crystal at a random frequency, said crystal to be of the POWER type, and its frequency will be stated accurate to better than a tenth of 1%. All crystals are absolutely guaranteed, and immediate deliveries. Add \$10.00 to the above prices if crystal is to be mounted in our POWER type of Holder.

### BROADCAST BANDS.

We desire to announce that we can make prompt delivery on crystals ground to your assigned frequency accurate to PLUS OR MINUS 500 CYCLES for \$45.00 Unmounted or \$58.00 Mounted. In ordering please mention plate voltage and type of tube used. These crystals are absolutely guaranteed.

We are at your service to grind for you, crystals other than mentioned above. We will be glad to quote prices for your particular requirement. Crystals ground to any frequency between 40 and 10,000 Kilo-cycles.

SCIENTIFIC RADIO SERVICE *The Crystals Specialists* P.O. Box 86, Dept. ZD, Mt. Rainier, Md.

## RADIO OPERATORS

Are You Handicapped by a Weak Arm or other weakness?

95 out of every 100 operators are handicapped by some weakness. Are you one of them? Would you place yourself in the hands of an expert who has developed many of the world's fastest and highest-paid operators, and follow his easy instructions if you thought his methods would make you STRONG, VIGOROUS AND CONFIDENT? If you knew positively that his system would increase your sending and receiving speed 50 to 100% and make you a TOP-NOTCH operator? Don't delay. Write me in confidence. No obligation. Write NOW!

WALTER H. CANDLER, Originator and Director  
THE CANDLER SYSTEM CO.  
6343 S. Kedzie Avenue Chicago, Illinois

## TRANSFORMERS, CHOKES COILS . . . . .

of all descriptions made  
to your specifications.

The crying need of the radio constructor and amateur for efficient coils, chokes, and transformers for either transmitter or receiver construction, is filled by the "Most Efficient" Power equipment manufactured by I. R. NELSON CO.

The new and radical core design developed by this company gives the small power transformers and coils all the efficiency inherent in large electrical construction work. Write in your wants. We will be glad to quote you. You will be surprised at the quality received for your investment. Prompt delivery on all orders.

I. R. NELSON COMPANY  
Bond Street Newark, N. J.

Don't Miss the  
Timely Suggestion

on

Page 94

NEW !!

Flechtheim Superior Volt-  
meters

0-300 v DC .....\$ 6.00

0-500 v DC .....\$ 8.50

0-600 v AC & DC \$10.50

Accurate and Dependable,  
for "B" eliminators, etc.

## FLECHTHEIM SUPERIOR CONDENSERS

"A More Effective and Dependable  
Condenser—for Less Money"

A radio receiver, an efficient transmitter, or a high-power eliminator, when equipped with Flechtheim Superior Condensers, will last longer, give better service and greater efficiency. The wise "ham" knows. Ask him.

78's W 2afs, Chief Engineer.

Write for catalog and prices to Dept. QT

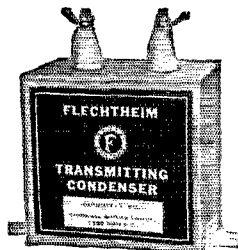

Type T200

A. M. FLECHTHEIM & CO., Inc., 136 Liberty St., New York, N.Y.

# HAM-ADS

**EFFECTIVE** with the October issue of *QST* the following changes were made in the rules of this department. The Ham-Ad rate is now 15c per word. The restriction which has limited use of this column to members of the American Radio Relay League is removed and advertising may be signed either by company name or by an individual. A special rate of 7c per word applies to advertising which is obviously non-commercial in nature and which is placed and signed by an individual member of the American Radio Relay League. Please read carefully the following conditions under which advertising in these columns will be accepted.

- (1) Advertising shall pertain to radio and shall be of nature of interest to radio amateurs or experimenters in their pursuit of the art.
- (2) No display of any character will be accepted, nor can any special typographical arrangement, such as all or part capital letters, be used which would tend to make one advertisement stand out from the others.
- (3) The Ham-Ad rate is 15c per word, except as noted in paragraph (6) below.
- (4) Remittance in full must accompany copy. No cash or contract discount or agency commission will be allowed.
- (5) Closing date for Ham-Ads is the 25th of the second month preceding publication date.
- (6) A special rate of 7c per word will apply to advertising which, in our judgment, is obviously non-commercial in nature and is placed and signed by a member of the American Radio Relay League. Thus, advertising of bona fide surplus equipment owned, used and for sale by an individual or apparatus offered for exchange or advertising inquiring for special equipment, if by a member of the American Radio Relay League, takes the 7c rate. An attempt to deal in apparatus in quantity for profit, even if by an individual, is commercial and takes the 15c rate. Provisions of paragraphs (1), (2), (4) and (5) apply to all advertising in this column regardless of which rate may apply.

**PLATE POWER** for your set, the very heart of its performance. For quietness, DX ability, life-long permanence, absolute dependability, lowest ultimate cost, no other plate source even approaches the achievement of an Edison steel-alkaline storage B battery. Built painstakingly every joint pure nickel, upset-electrically welded. Genuine Edison Electrolyte. Our list describes complete batteries, construction parts, enameled aerial wire, silicon steel. Rectifier Engineering Service, radio SML, 4837 Rockwood Road, Cleveland Ohio.

**HAWLEY** Edison element battery and parts standard for over five years. Look at our patent pending connector—no thin wire to drop off—contains 20 times more metal than regularly used. Heavy shock proof cells, fibre holders, etc. Everything for a rapid-fire "B" supply. Complete assembled 100 volt "B" \$10.00. Knock-down kits at still lower prices. Chargers that will charge in series up to 160 volts \$2.75 to \$4.00. Trickle B Charger for 90 to 150 volt "B" \$3.75. Special transmitter "B" batteries up to 6,000 milli-amp capacity, any voltage. Write for interesting literature, testimonials, etc. B. Hawley Smith, 360 Washington Ave., Danbury, Conn.

**ENSALL** Radio Laboratory receivers and Transmitters are of the most modern designs and are supplied to meet any particular requirements of the radio art. Transmitter designs for radiophone or C. W. Our long experience in the designing of special apparatus is your guarantee of quality and efficient apparatus. We also build to order any items desired. Literature on any apparatus forwarded on request. Ensall Radio Laboratory, 1208 Grandview Ave., Warren, Ohio.

**CRYSTALS:** 85 meter band \$15.00 175 band \$10.00. Blanks \$4.00. Hollister, 9DRD, 930 Baltimore, Kansas City, Mo.

**DUBILIER** .004 transmitting condensers wanted. Radio, 150 West 22nd St., New York.

**A.R.R.L.** sweater emblems should be worn by all members. They are made of the highest grade black and yellow felt, 5" x 8" diamond. \$1 postpaid. Eric Robinson, 185 Jefferson Road, Webster Groves, Mo.

Used 208 A and 211 \$18; new 217 A \$23; new 352 \$23; used \$20; used Western Electric 212A and 212D \$60 each; new Cunningham and RCA 210 \$6; new Cunningham and RCA 281 \$5; No. 12 enameled aerial wire \$.90 per 100; Amateur Call Books \$.85; 10" insulators \$.29; Freshman 375V. and two 7 1/2V. center tapped transformers \$2.75; Robbins & Myers motor generator \$65; all types used Jewell meters \$.75 each; three tube wired Aer coil set, best equipment \$20; REL 50 watt sockets \$1.50; signal corps 3/16" contact key \$.95; 210 Bradlaystays \$1.75; free list, lots of used and new apparatus. What have you for sale or trade? David L. Marks, 125 Madison Ave., Albany, N. Y.

**OMNIGRAPHS,** Teleplexes, condensers, dynamotors, transmitters, receivers, chokes, meters, transformers, crystals, 50 watters, supersyns, S tubes, Vibroplexes, electric and portable receivers. Phone transmitters. Bought, sold, exchanged, L. J. Ryan, 9CNS, Hannibal, Mo.

**WANTED:** One Western Electric burned out 211D. W4PAU, Box 2126, Auburn, Ala.

**TRADE—32V** motors for 750-1000V small used generator. 9FYF, Ashley, Mo.

**WANT** to get in communication with other railroad Morse operators who are operating stations. Write C. C. Cushman, Operator, C & N W RR, Hooper, Nebr.

**SELL REL** shortwave two tube receiver assembled partially wired, \$10.00 prepaid. Lawrence B. Smith, Osage, Iowa.

**SWAP** almost new 24 volt-1500 volt dynamotor, also transformer 1500 each side center tap. 50 watt WE tube, for tanned skins or mounted birds and animals suitable for decorating den. Dr. E. H. Cunningham, 5LN, 101 Baylor St., San Antonio, Texas.

**SELL** complete portable transmitter and receiver. W1PL.

**WANTED—Complete** 7 1/2 watt transmitter. Give full description and price. H. L. Fuller, 1912 Railway Exchange Building, Saint Louis, Missouri.

**QSL** cards, two colors, \$1.00 per hundred. Free samples, 8DTY Parker Ave., Buffalo, N. Y.

**ESCO** motorgenerator 500 V 50 Watt with 2 1-Mike condensers 20 H Choke. Perfect condition \$35.00, W2BDC, 181 Greenwood Ave., East Orange, N. J.

**Guaranteed quartz oscillators** for the new 80-meter band complete with foolproof holder, mountable brass discs with lapped surfaces, complete and prepaid upon receipt of \$20.00. W2BDC, 181 Greenwood Ave., East Orange, N. J.

**THORDARSON** 650-volt power-filament transformers for 7 1/2-wattors \$6.90. Aluminum square-foot 85c; Lead square-foot 85c. Electric-Bugs \$10.50. Potter 2-mfd. 1000-volt condensers \$2.50; 2000-volt tested 1-mfd. \$2.50; 2500-volt 1-mfd \$3.25, UX210 7 1/2-wattors \$5.25. UX-250's \$7.50. "Ham-List" 4c. James Radio Curtis, 1109 Eighth Avenue, Fort Worth, Texas.

**Thordarson T-2382-12-volt filament-transformer \$7.50;** Thordarson 550-850 power-transformer \$11.00; Thordarson 1000-1500 power-transformers \$16.00. **Homemade** 350-550 power-filament transformer \$4.00. Jewell 0-500 Milliammeters \$6.00; 0-15 AC-voltmeters \$6.00. Slightly used 50-wattors \$17.50. Robert Curtis, 1109 Eighth Ave., Fort Worth, Texas.

**TRANSMITTING** set and motor generator for sale. New. Enclose stamp. Norris Preston, Armstrong, Mo.

**FVP** selling entire station, transmitter and receiver, for \$125. UX352 and mercury arc rectifier. If interested write for complete list. Milton Schwalbe, 2119-63rd Street, Brooklyn, N. Y.

**FLUSH** mounting A. C. voltmeters 0-10, \$1.25. Ed Keers, 9CJR, 2300 E. Washington St., Joliet, Ill.

**QSLs,** one hundred two color \$1.00. Government \$1.90. Radiograms, stationery. Samples. 9CKA, Corwith, Iowa.

**Motor generator bargains,** 750 volt, 200 watt, two commutator new General Electric motor generators direct connected to 110 volt, 60 cycle, 3500 R. P. M. single phase A. C. motors each \$45.00. 350 volt, 150 watt new General Electric motor generators direct connected to 110 volt, 60 cycle, 3500 R. P. M. single phase A. C. motors, with field resistance, each \$27.50. New 1/4 HP, General Electric and Westinghouse 110 volt, 1750 R. P. M. A. C. motors \$37.75 each. New television variable speed motors for 110 volt, alternating current \$7.00 each. A limited number of each of the above items. Also many others. Write us your needs. Electrical Surplus Company, 1911 Chicago Ave., Chicago, Ill.

POSTPAID anywhere. Panel mounting, flush type Milliammeters. Hand calibrated and accurate. Your choice 0-100, 0-500, or 0-400 scale, \$1.25. New price list now ready to mail on request. G. F. Hall, 535 West Horrtter St., Philadelphia, Pa.

MASTER radio wavemeters. 15-200 meters, \$5.50 and \$8.50. Send for description. Imported 50 watt transmitting tubes. Low internal-capacity-\$9.50. W E 5 watters-\$3.00. G E Neon lamps-95c. \$1.00 Aerovox 5000 ohm wire-wound Gridleaks-50c. Dudlo-wound 50 Henry, 300 milliamperes chokes-\$2.85. Mayolian 6 mfd. 1000 working voltage filter condensers-\$4.25. 30 Henry, 100 Milliamperes chokes-\$1.85. Pure rectifier elements. Complete, per pair: 1x4-7c, 1x5-8½c, 1x6-10c. Extra-heavy: 1x4-12c, 1x5-13½c, 1x6-15c. Copper tubing inductance. 35 Gauge extra. Send for "Specials." William Harrison, 85 Ft. Washington Ave., New York City.

TUBES—Perryman UX216B, \$1.95. Navy 5 watters, \$1.85. Sylvania UX210, \$5.50. UX250, \$7.50. Will swap Ross rifle 303 cal. for SW Xmitter. Complete. H. MacLeod, Seaford, N. Y.

USED generators 275 volt d. c. \$8. 500 cycle 200 watt alternators, \$10. ½ kw. \$15. 6 volt input, output 400 volts at 200 watts d.c. \$15. R. Wood, 46-20 102nd St., Corona, N. Y.

WANTED: Navy standard receiver SE143, SE1220, or SE1420 or IP500 or IP501, also want audio control box SE1071. State condition, manufacturer and price. Paul Trautwein, 15 Albany St., New York.

TRANSFORMERS for eliminators, filament lighting, power packs and low power plate supply at factory prices. High grade Silicon steel, three leg core type punchings used for highest efficiency. Send for catalog. Electro-Tone Laboratories, 834 N. Randolph, Philadelphia, Penn.

NEW Morton Electric Company, motor generator sets 750V, 200W, \$45.00. 1000V, 200W, \$50.00. 1000V, 250W, \$55.00. Wickedly direct connected to 110V, 60 cycle, 1 Ph. motors. A Forbes, 4832 Rice St., Chicago, Ill.

FINAL Supply. Eight hundred brand new ball bearing generators just purchased from the Navy. General Electric 24/1500 volt .283 ampere triple commutator dynamotors \$37.50 with shaft adapted for external drive \$3. additional. General Electric 24/750 volt 2 ampere \$27.50 shaft \$3.00. Crocker-Wheeler 24/1500 volt 450 watts \$45. Holtzer-Cabot 12/500 volt 35 watts \$20. 500 watt 500 cycle generators with exciters \$15. Transformers \$10. 900 cycle 200 watt with complete spark set \$30. Others in stock for your requirement. Literature and fotos. Henry Kienzie, 501 East 84th St., New York.

PLATE and filament supply transformers for 25, 40, 50, 60 and 500 cycle supply. Filter chokes and special coils built to order. Transformers and filter chokes exchanged. Scott Coil & Transformer Co., New Albany, Mississippi.

TRANSFORMERS, 8 volt, 75 watt, \$5.75; 12 volt, 150 watt, \$6.50; mounted. Send for Ham List No. 2. Robert Annis, 524 N. Oriental, Indianapolis, Ind. 9CUD.

QRH? Twenty-nine is almost here. Better have that wavemeter calibrated in frequency to a high degree of accuracy. 9BVC, Lutesville, Missouri.

SPECIAL made rectifier aluminum with small percentage copper, stand more amperage, last longer, square foot \$1.25. Lead \$1.00. Elements, holes punched with bolts and nuts, new kind 1"x4" 15c, 1"x6" 17c. old kind 1"x4" 18c, 1"x6" 15c pair prepaid. Best Silicon steel .014" cut to order 25-35c lb. Postage extra. Geo. Schulz, Calumet, Mich.

CHEMRAD radio chemical outfit. Experimenters, you should know radio chemistry, the alluring, thrilling, new science. Complete outfit includes chemicals, metals, apparatus, instructions sufficient to carry on chemical and radio experiments, even television. Send \$4.98 money order, or sent C.O.D. Satisfaction guaranteed. Chemical Radio Co., 4780 D Drexel Blvd., Chicago.

WANTED—Grebe CR-5 in good condition. State best price. A. L. Budlong, A.R.R.L. Headquarters.

SELL or Swap—New Thordarson 500 watt plate transformer 1500 and 200 centertapped \$17.50. New Thordarson combined plate and filament transformer 650 and two 7½ volt filament windings \$5.00. A few new Western Electric 211D fifty watters \$28.00. Slightly used Thordarson 900 watt plate transformer 1000 and 1500 centertapped \$18.00 and Acme 75 watt filament transformer \$6.00. I. Wolfe, 153 Schenck Ave., Brooklyn, New York.

1500 volt 500 watt motorgenerator 3-phase drive \$125.00; 220 volt single phase \$156.00. 1000 volt 200 watt motorgenerator, 110 volt AC drive \$75.00. 750 volt 200 watt motorgenerator, 110 volt AC drive \$45.00; 300 watt \$65.00. 350 volt .15 ampere motorgenerator, 110 volt AC drive \$22.50. 410 volt 100 watt generators, \$8.50. Couplings \$1.75. ¼HP. 3450 speed motors \$8.50; 1750 speed \$7.00. Also larger motors and generators. Queen City Electric Co., 1734 Grand Ave., Chicago, Illinois.

HAM sale—transmitting and receiving parts. Sold separately or exchanged for 85¢. Send for bargain list. E. Lacey, 561 Ontario St., Schenectady, N. Y.

WANTED 204A guaranteed or what have you. Have Roth constant potential charging outfit complete, type MRC1. 110-220 single phase, cost \$275. Perfect condition for exchange. W2ANS, New Rochelle, N. Y.

QSL cards. Cartoons. Hams say best made! H. M. Selden, Cranesville, Pa.

2500 volt 1000 watt motorgenerator. 220 volt AC drive, \$2.25. James Smat, 1734 Grand Ave., Chicago, Ill.

TRANSFORMERS 325-325, 7½-7½ \$5.50. 275-275, 5, \$4.00. 250 watt unmounted 2000, 1500, 1000 volts mid-tapped \$8.00. Chokes, 250 MA \$7.50, 150 MA \$5.00, 100 MA \$2.00. Write for specifications. Radio Parts Sales Co., Orange, N. J.

ODDS and ends. Single 50 meter REL inductance, \$3; UV204 mountings \$1.25; UP1658 30 henry choke \$4; UP1616 fifty watt transformer \$18. 2mfd. 2500 volt Flechtheim filters \$5 each (2); UM576 O-500 milliammeter \$5; UT541 fifty watt socket, \$1.50; UP1868 325 watt transformer \$12; two 250 watt kenotrons \$85 each; UM581 0-5 thermometer \$5; Lynch relay \$5. W. M. Derrick, 80 Leslie St., East Orange, N. J.

"SPEED Limit was 10—just managed to get license and stuck there until tried Dodge Radio Shortkut. Can now hit 20 per and shall soon be Commercial First—all thanks to you." So reports MEASE, SANP. Method \$3.50 United States. Elsewhere \$4.00. Money order only. C. K. Dodge, Mamaroneck, New York.

WANT several back numbers QST in 1921 and 1922 and all previous dates. Write 9APM, Des Moines, Iowa.

STILL soliciting burned out tubes, odd types for my tube collection—foreign country correspondence desired. Write 9APM, Des Moines, Iowa.

## Q R A SECTION

50c straight with copy in following address form only:

The following stations belong to members of the A.R.R.L. Headquarters gang. Mail for them should be addressed care A.R.R.L., Hartford, Conn. When operating W1MK they use personal sines as indicated.

### W1MK

- A.R.R.L. Headquarters, R. B. Parmenter, Chief Op. "rp."
- L. R. Huber "ou."
- R. A. Hull "rah."
- W1AL H. P. Westman "wa."
- W1BDI F. E. Handy "fh."
- W1BHW-W1EH K. B. Warner "kb."
- W1BMM-W1FL G. D. Meserve "dm."
- W1BUD A. L. Budlong "bud."
- W1CEI-W1SZ J. J. Lamb "jm."
- W1ES A. A. Hebert "ah."
- W1KP F. C. Beekley "beek."
- W1PX C. G. Keneffick "ek."
- W1SZ-W1BIZ C. C. Rodimon "rod."

ysIFM—J. Fred Mejia, 7a Avenida Norte No. 19, San Salvador, El Salvador, Central America.

W2BUO—Werner H. Oupe, 14 Brooklyn Ave., Jamaica, L. I. N. Y.

## More Profits To Set Builders

Elections, football games, big National events will boost radio business this year. Set builders will reap a rich harvest. Barawik service will make you money. Everything in A-C sets, short wave, television, parts, supplies. World's largest radio stock on hand. Orders shipped same day. Lowest rock-bottom wholesale prices.

Write for Free Radio Catalog

**BARAWIK CO.** 1112A Canal St., CHICAGO, U. S. A.







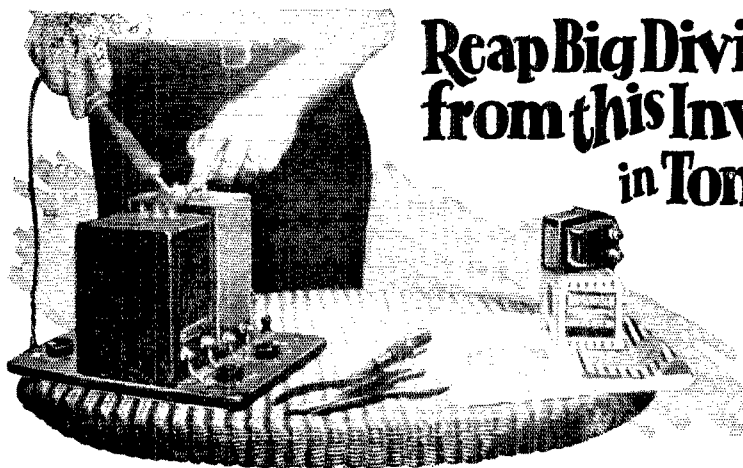

# Reap Big Dividends from this Investment in Tone Quality

## A Thordarson Power Amplifier (Home Constructed) Will Transform Your Radio Into a Real Musical Instrument

WITH the insistent demand for quality reproduction, power amplification has become a vital radio necessity. Today, it is hard to find a radio set manufacturer who does not employ one or more power tubes in the output stage of his receiver.

There is no need, however, for you to discard your present radio instrument in spite of the fact that it is outclassed by newer models with power amplification. You can build a Thordarson Power Amplifier which, attached to your receiver, will provide a fullness and richness of reproduction that will equal or surpass the finest offerings of the present season.

Thordarson Power Amplifiers are exceedingly easy to assemble, even for the man with no previous radio experience. Only the simplest tools are used. Specific instructions with clear-cut photographs, layouts and diagrams insure success in home construction.

Whether your present receiver is factory made or custom built one of these amplifiers may be attached with equal ease. In fact, most Thordarson Amplifiers require absolutely no changes in

the wiring of the receiver itself, attachment being made by means of a special plug which fits the last audio socket of the receiver.

Thordarson Power Amplifiers for the home constructor and professional set builder range from the simple plate supply unit up to the heavy-duty three stage units employing the 250 type power tube in push-pull arrangement. These power amplifiers cover the requirements for every purpose and every pocket-book. They may be used with any type of horn, cone or dynamic speaker.

With a background of over thirty-three years manufacturing quality transformers, it is only natural that so many manufacturers of receiving sets of undisputed superiority have turned to Thordarson as the logical source of their audio and power supply transformers. The discriminating home constructor will do well to follow the lead of these manufacturers when buying his power amplifier.

Write to the factory today, enclosing 25c for the new "Power Amplifier Manual"—just off the press!

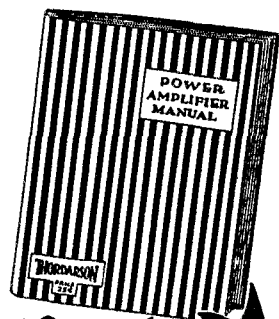

*New!*

No Amateur or Professional Set Builder Should Be Without This Book—

"POWER AMPLIFIER MANUAL"

A simple, yet complete, treatise on the subject of audio and power amplification, including full information on building, servicing, and testing power amplifiers in general. Also contains detailed specific construction data on twelve individual power units, with clear-cut layouts and diagrams of each.

25c

Send 25c in Cash or Stamps for This New Book—  
Just Off the Press!

### MAIL THIS COUPON TO-DAY!

THORDARSON ELECTRIC MANUFACTURING CO.  
500 West Huron Street, Chicago, Illinois

Gentlemen: Please send me your new "Power Amplifier Manual" for which I am enclosing 25c.

Please send me free of charge your instruction sheet on the amplifier I have checked below:

171 Single  171 Push-Pull  210 Single  210 Push-Pull (1 Stage)  210 Push-Pull (2 Stage)  250 Single (1 Stage)  250 Single (2 Stage)  250 Push-Pull (3 Stage)  210 Phonograph Amplifier

Name.....

Street and No.....

Town..... State.....

RD 66 P

# THORDARSON RADIO TRANSFORMERS

SUPREME IN MUSICAL PERFORMANCE

# The national success of the CROSLLEY AC Electric GEMBOX at \$65 is recommendation enough



OPERATES  
POWER  
SPEAKER

CROSLLEY  
DYNAPHONE  
\$25.



3 Tube AC Electric  
**SHOWBOX** \$80  
Genuine Neutrodyne, with  
push-pull audio and two  
171 power tubes in the  
last audio stage.



**MUSICONE** \$15  
An improved magnetic  
type speaker delivering  
clear, sweet tones and  
natural reproduction.

Extract every bit of enjoyment from the air with this amazing radio which only Crosley dealers sell!

Sales records shattered this season, report Crosley dealers from coast to coast. Why? What is the reason?

Ask any Crosley dealer near you to hook a Crosley radio to your antenna and then that question answers itself.

You will be thrilled, for you will hear radio reception so realistic, so beautifully rich and mellow and so full toned that you will say—"This is radio I never thought could be possible."

And when you contemplate the price—\$65, and note the latest radio features . . . shielding . . . power speaker operation . . . illuminated dial and neutrodyne circuit, you will understand fully why Crosley Radio is such a tremendous success!

**THE CROSLLEY RADIO CORPORATION**  
CINCINNATI, OHIO  
Powel Crosley, Jr., Pres.

Montana, Wyoming, Colorado, New Mexico, and West  
prices slightly higher.



6 Tube Battery Type  
**BANDBOX** \$55  
Genuine Neutrodyne, con-  
tains new features as in  
the AC set; operates a  
dynamic type speaker.



5 Tube Dry Cell  
**BANDBOX, Jr.** \$35  
For use where storage  
battery recharging is in-  
convenient; operates the  
**MUSICONE**.



Coupon  
 The Crosley Radio Corporation  
 Dept. 18 Cincinnati, O.  
 Please send me literature regard-  
 ing the Crosley radio  
 I have checked .....  
 Name .....  
 Address .....

**"You're there with a Crosley!"**

Prices quoted are without tubes

Say You Saw It In QST — It Identifies You and Helps QST

# AERO COIL

Super-Sensitive  
INDUCTANCE UNITS

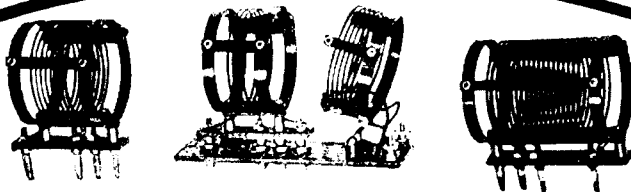

Of course you want your new receiver to be the last word in sensitivity—to give you the greatest distance range and consistent reliable performance. Then build it around the famous Aero Interchangeable Short Wave Transmitting Coils. Aero Coils are acknowledged to be the finest short wave coils obtainable. Their patented construction makes them ninety-five percent air dielectric, with less than one-sixth the losses of celluloid or bakelite. The new two inch diameter coils have proven immensely popular. The Aero Short Wave Tuner Kit, LWT-12, illustrated above, consists of three Aero Interchangeable Coils and base mounting with Primary Coil. *Price Complete, \$12.50.*

## Aero Interchangeable Transmitter Kits

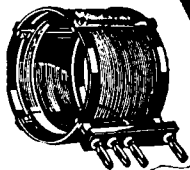

The range of the LWT-12 Kit can be considerably increased by adding Aero Coil No. INT-4. This coil can be plugged into the LWT-125 mounting base and has a range of from 125 to 275 meters.  
Coil No. Int-4 ..... \$4.00

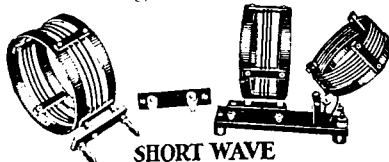

### SHORT WAVE

Aero Coils have proven themselves to be the best low power transmitting coil on the market. Each kit includes all necessary parts for a tuned plate transmitter including base with variable antenna and plate coil, grid coil and two plate coils. Kit No. K2000 has a wavelength range of 16 to 25 meters. Kit No. K1080 range from 26 to 40 meters. Kit No. K1000 has a range of 90 to 150 meters. These kits are priced at \$12.00 each. Plug in Coils make it easy to change from one wave length band to another.

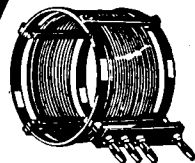

The range of the LWT-12 can be still further increased by adding Aero Coil No. INT-5. This coil has range of from 250 to 550 meters.  
Coil No. INT-5 ..... \$4.00



Aero Coil Kit No. LWT-10. For use with Foundation Units containing plug-in mount, or replacing LWT-125 Coils. Same three coils as in LWT-12 Kit.  
No. Lwt-10 ..... \$10.50

**THE NEW 1929  
AERO GREEN BOOK**

Contains data needed by every amateur builder of plug-in wiring diagrams of receiver and transmitters. Information about new developments. Send 25 cents for your copy.

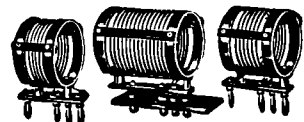

Aero Coil No. LWT-11 contains a plug-in mounting base without primary and three coils as used in the LWT-12 Kit. Range 16.5 to 89.5 meters.  
Kit No. LWT-11 ..... \$11.50

## AERO PRODUCTS INCORPORATED

Dept. 398

4611 E. Ravenswood Ave.

Chicago, Ill.

# BURGESS BATTERIES

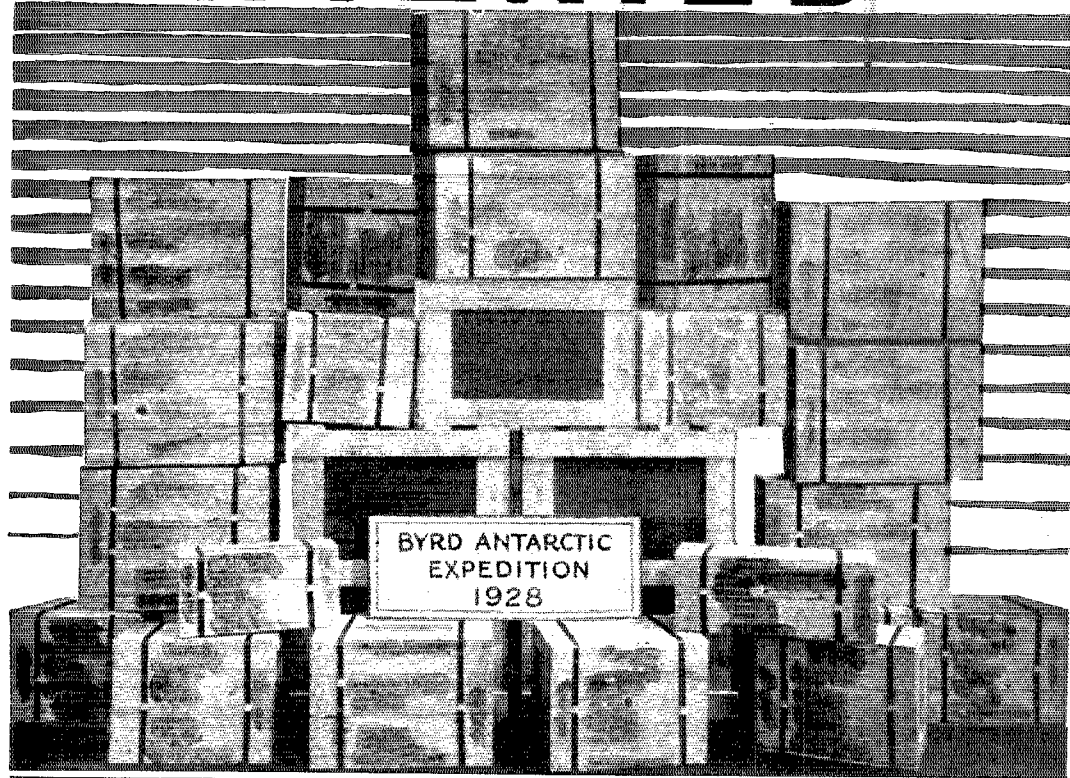

*with Commander Byrd's antarctic expedition*  
*"Ask any Radio Engineer"*

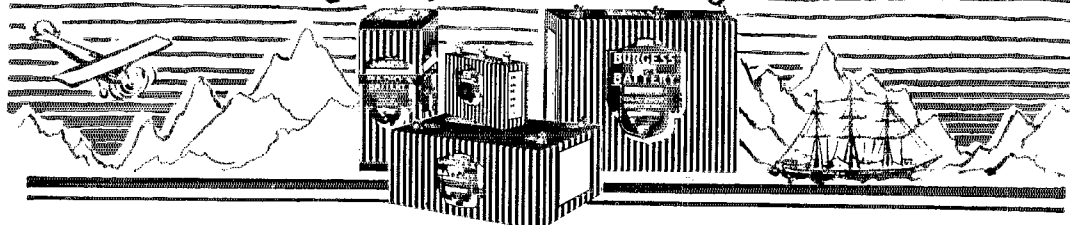

**BURGESS BATTERY COMPANY**  
MADISON, WISCONSIN

# The Communications Department

F. E. Handy, Communications Manager  
1711 Park St., Hartford, Conn.

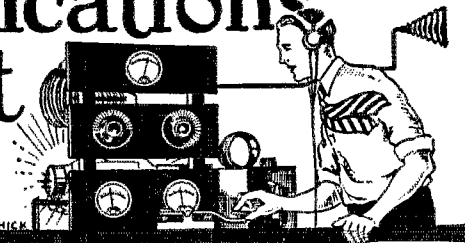

## About That W

**D**O YOU use the W as part of your call signal each time it is transmitted? You *should*. It has been called to our attention that some few amateurs are still signing the old way—or using the W just part of the time which makes a dizzy combination to figure out.

It must be remembered that the first letter or letters prefixed to our calls are actually just as much a part of the call as the W in WIZ or the K in KDKA. In getting QSL-cards printed the W should be the same size as the other letters. It should not be separated from the rest of the call signal by a hyphen or extra space.

As for operating correctly, of course, habit is a strong master to overcome. However, a single night of practice with the correct procedure in mind should be sufficient to get us to signing our new call signals prefixed by W, K, VE etc. properly.

It should be a source of pride that we can revise our operating practice as required to avoid confusion and non-uniformity without any unnecessary delay. A station owner should be ashamed to permit his call to be incorrectly used two months after a change has been made. Let's familiarize ourselves with the knack of using our new calls correctly and let us courteously remind those who need to be told of the correct procedure.

Sign *correctly* at all times. Don't forget that "de" must be used. No attention sign (-.-) is required preceding a call. There is no excuse for a lot of meaningless material appended to the call when ending a transmission either. Most of the key tapping we hear after the sign-off causes needless QRM and does little except to indicate the extreme youth or weak-mindedness of the individual who is trying to be "smart."

## Use the New Procedure

**T**HIS brings us to another subject—that of introducing the new abbreviations and operating practices. Let's get busy and replace the obsolete R system with the simpler and better QSA (1 to 5) audibility code. Revise your calling practice to make all CQ's informative, indicating continent, country, district, state, direction or the like. Don't forget to make full use of the new Q code and the standard abbreviations determined by the international conference for indicating "yes" and "no," for asking for repetitions of parts of conversation and messages.

Do you know the meaning of AA, AB, AL, BN, WA, WB, TXT etc.? Do you know how domestic calls are made differently than foreign calls in which the directional CQ is used? What does QSA2 mean? These things are all explained in the revised Rules and Regulations of the Communications Department which will be sent to anyone without obligation, on receipt of a postal card.

It is requested that you put these convenient abbreviations and practices into daily use at once. The new abbreviations are mandatory on all radio services. They are understood internationally. They are time savers for all, reducing needless interference. Explain your meaning if necessary and tell the fellows you work to send for a copy of the R. & R. but most important of all *use the new standard practices*. You

will enjoy the business of brisk, snappy operating with the new abbreviations whether in rag-chewing or message handling just as soon as you get the knack of using them regularly. Be up-to-date and correct at the same time and you will like the game all the better. Other stations often note your operating. What kind of an impression do they receive? Do they have to be tactful or can they frankly discuss "stations" and "fists" with you? *Use standard amateur procedure.*

## Emergencies—Are You Ready?

**O**NE never knows when a sudden wind storm, a heavy rain, or a nor' easter with sleet and snow will develop into a real emergency. In preparing our station for the future it is a good scheme to have an oscillator, monitor, or grid-meter driver on hand that can be converted quickly into a low-power emergency transmitter to meet the needs of any occasion. While planning emergency sets we should remember to make note of the availability of different emergency power supplies so that no time will be lost in time of actual trouble. A day or two spent in construction of simple apparatus now will save precious hours if and when an actual emergency occurs.

In the future, stations will be equipped to listen regularly to their own transmissions to check quality, frequency, and steadiness—if they are to be considered among the *first rate* amateur stations. Have you built that MONITOR yet?

## 28-Megacycle Work

**FLASH!!!** The latest good news from W6UF was received at W2AVG (and copied by W2WS also) Nov. 9 on 28 mc. The radiogram reads, "TWO-WAY COMMUNICATION WAS ESTABLISHED WITH ZL2AC ON 28 MC. AND MAINTAINED FOR ONE HOUR AND FORTY MINUTES ON NOVEMBER EIGHTH (SIG.) W6UF". W2WS and W2AVG both reported W6UF as very strong and steady during the entire noonday of November 9. A message from ZL2AC to Hq. which travelled all the way via W6UF and W1BJD on 28 mc. opened up the new band officially for long distance message handling on November 11.

The 28 mc. band is now being used regularly for international QSO's. Let's QSY and make more general use of this interesting band!

**R**EPORTS of 28 mc.—signals from the U.S.A. which have been heard across the water on different occasions have been followed by the first two-way 28 mc. work between England and the United States. On October 21 G2OD (E. J. Simmonds, Middlesex, England) was in communication with W1AQD (L. C. Brown, Livermore Falls, Maine) on 28 mc., sending greetings from the R.S.G.B. to the A.R.R.L. on that occasion! W2JN also worked G2OD on the same day. The following week W6UF (Bill Eitel, Knowles, Calif.) and G2OD

were also QSO! ZL2AC has been heard at W6UF and W6BAX and it is quite likely that by this time two-way work across the Pacific will have been accomplished on 28 mc. A radiogram from ZL2AC to A.R.R.L. received during the early November tests made from W1CZZ with a beam antenna reports that ZL2AC heard W1CZZ on November second from 2015 to 2230 GCT at various strengths between R3 and R6, with a thirty-degree angle of the beam at W1CZZ giving the best signals. As far as we know, this is the longest one-way transmission on this frequency that has yet been recorded.

With excellent radio conditions on 28 mc. for the past month, the consistency of general communication has approached that obtained on 14,000 kc. So much useful two-way communication has taken place all over this country on 28 mc. we feel that it may be necessary to abandon this column soon—or at any rate to mention only unusual results or those from which some definite conclusions can be drawn to improve the reliability of 28 mc. QSO's with equipment easily duplicated by any amateur. With methods of adjustment that overcome irregularities in the transmitting conditions we shall find ourselves with a useful and excellent communication band to relieve the congestion on some of the other bands used for DX work.

Judging from all reports, conditions improved steadily during October. On September 30 G2NH reports that BR898 heard W2JN, W2BDA, and W2MM. G6NH copied W2JN when he was calling ef8PRO this same date. W2AQB (also calling ef8PRO) was also heard in London, England R4 at 1635 GCT September 30. On October first G6DH copied W2AVG, W2AZU, W8ADM, and W1TR who was calling W9MT. About this date W6DZK (Salt Lake City) reported hearing K6CLJ (Hawaii). October seventh W8DJV and W6AOT clicked on 28 mc. for the first time. This contact was overheard by W2TP who also copied W6DHS, W6XV, and local 28 mc. stations. W8DJV copied W6XV, KES-KLL, and worked W8CBM. On October 14 W2TP worked two-way with W2ACN, W5AOT, and W5AUZ. W2ACN also hooked with W5AOT on this date. Conditions were good and W1BJD (Mass.) copied W5AOT, W5TP, and W5QH on 28 mc. On October 20 both W2TP and W4NH worked W5AOT. The next day was that on which the contact between G2OD and W1AQD was made. G2OD was also copied solid by operator Brown of W4NH on this occasion. W4NH heard W5AOT, W5AUZ and W6UF and established communication with W6UF on the twenty first. On this date W6UF heard ZL2AC. Also W2JN worked G6LL from 1435 until 1625. The signals were steady and excellent throughout. On finishing with G6LL, W2JN called CQ and almost immediately raised eo17C who was worked for the next hour. There was increasing fading on this transmission. On this same date W2TP worked W6UF, VE4CT, W5AUZ and heard W5AOT. W2JN also heard VE4CT, W6UF and W6OK. W2JN reports that the new band has opened up like a book and produced excellent signals from all over. W2JN worked K4AGF (Santurce, P.R.) on October 7 at 1430 GCT. W5AOT, W5TP (on harmonic) and VE4GO were heard on October 14. October 22 W2JN worked G2FN for a half hour or until he faded out. G6DH was heard on the twenty second. W6CZA was copied on Oct. 26 and on Oct. 28 K4SA and G2KF were both heard at about 1840 and G6LL was worked again for over an hour. W1BVL worked W6UF on Oct. 21 and copied VE4CT and W9BHB. On the 23th he heard K4AGF at 9.40 am EST and at noon copied G2FN (R3) working W6UF (R5).

W4ACT (Moultrie, Georgia) copied the following 28 mc. stations on Oct. 23: W6DIY (R5), W8BCQ (R4), W2CW (R5), W9AEZ (R6), W8BA1 (R4), W6EA (R4). This same date W6BAX copied W1AQD (R4), W1TR, W2TP, W2FJ, W2AQB, W6UF, W9APA, W1RY, W5AFB and W5AQ. A radiogram received later from W6BAX (via W2BDR) reports the following signals heard: "W1CZZ R8 1.25pm PST Nov. 3, W1CZZ R7 10.50 am, R6 11.10 am, R7 2.20 pm PST on 201A. I heard the following on Nov. 4. W2AZO, W2AOL, W2TP, W1ZL, W1AQD, W2BVG, W2ACN, on ten meters. Also heard ZL2AC R8 all afternoon." W5AFB (Dallas, Tex.) reports two way work with W1AQD, W1BJD, and W6UF on Oct. 22. He says also, "The following ten meter signals came through O.K. on this date. W1AQD R6, W1BJD R3, W2AQB R4, W2FJ R3, W2TP R2, W6UF R4, KES, KLL R5, W1Z (harmonic) R3 W5AVS and W5WZ (Fort Worth, Tex.) heard several 14 mc. harmonics on Oct. 21, after

which they got the transmitter working and contacted with W1AQD and W1BJD between four and five pm CST. W5AVS-W5WZ got reports of R7 and R5 from these stations. W5AVS-W5WZ is crystal controlled on 23.64 mc. (10,475 meters). October 23 W1AQD worked G2OD for the second time also contacting with W6UF, W5AFB, and copying W5AOT. Ed Willis of W6TS copied W2XT Oct. 20, at 8.15 am PST. W6DZL finds 28 mc. an enjoyable band to work in with good signals and freedom from power leak and QRN backgrounds.

W2ACN broke the ice on the seventh of October by working W5AOT in spite of some local difficulties. Since then several other stations have been worked and W2ACN and W2TP are looking forward to some foreign contracts now there is activity across the water in several different directions. W2ACN says, "To work the west coast and get R5-7 is now common and several west coast stations can be worked at will all day Sunday as soon as they come on in the morning. W6UF is R6-8 all Sunday, W6BAX puts a mean signal across by crowding a 201A with 15 watts input! W6CUH and W6ANN come in fine. My receiver had the 28 mc. band crowded into 8½ dial degrees but by connecting a 5-plate midget condenser in parallel with the .000125 µf tuning condenser and connecting it to a good vernier dial with a long hard rubber shaft I have spread the band out over 55 degrees. This idea works on the other bands, too. My 1929 improvements cost me just 59c which may interest fellows who cannot rebuild throughout due to Christmas on the horizon."

W1ZL got a surprise on November 4 when he decided to listen on 28 mc. for the first time since last April. W6BAX rolled in R7 while working W2AZO. As soon as a hay-wire transmitter could be put together W6BAX was called and worked with one 1X210, 40 watts input. W6UF and W6CUH were copied all the afternoon. W6WB and W6ANN were heard calling W1CZZ and that station was R4. W2AQB was copied as well as VE4CT. West coast signals were strong and steady, the weather in the east, rainy and cool. W1ZL expects to try 28 mc. each Sunday, hereafter.

A radiogram from White of ZL1AO asks all U.S. 28 mc. experimenters to transmit and listen on Saturday afternoons, our time. ZL1AN and ZL1AO have heard our 28 mc. signals Sunday 10 to 11 am, New Zealand time. The New Zealand A.R.T. will gladly cooperate in any 28 mc. tests with the U.S.A. W8DJV reports that ZL2AC starts operation each Sunday at 2200 GCT. We also have it from W2TP that ZL2AC transmits Saturday afternoons from 3 to 4 pm and 9 to 10 pm EST. ZL2AC has heard 28 mc harmonics from HJO, W2XAD, NPM, KEL, and PCLL, at different times. He has also heard W6XV and W1CZZ testing.

W8XK is operating a crystal controlled transmitter on 28.8 mc. each Saturday and Sunday from noon until 8 pm EST, using compensated keying and a quarter wave vertical antenna. Reports should be mailed to Box 91C, R.F.D.5, Wilkinsburg, Pa.

W9DGZ sends a 15 minute test at 1 pm CST each Sunday, looking for stations calling him immediately after this.

Hollywood of W2AER reports, "Am going to M.I.T., Cambridge, Mass., and am starting 28 mc. experimenting in my dormitory room. Just to show what 28 mc. is like—built a receiver in a 5"x6"x9" cardboard box, the two tubes and junk cost \$8—and the first day (2.00-3.30 pm Nov. 4) I heard W6UF R5 dc, W6CUH R6-R7 dc, W6BGQ (21 mc.) R7 dc, and W1EK, W1MX, W1BVL, W1BJD and W1CZZ!"

## TRAFFIC BRIEFS

OM Diehl, SCM of Nebraska, sends us the following extract from the *Electric Shop Quarterly* (Omaha) The article is entitled "Electricity—What Is It?"

"Electricity is something that starts the Lord knows where and ends in the same place. It is faster on its feet, being 1-38 of a second speedier than its nearest competitor—backyard gossip—and when turned loose in Europe will get to the United States five hours before it starts. Nobody knows exactly what it is, because it has never stood still long enough. It is like your girl's younger brother in that you never know what to expect next, and the only way to handle it is with a switch. Rubber is the only thing that will stop it, which is why rubber-soles never get shocked, and rubber heels are shock absorbers, so they say in the suburbs.

"Electricity is sometimes known as science gone crazy with the heat and you can understand its maneuvers, you can do anything with it except open a can of peanut butter at a picnic. It had been locked up in ignorance throughout many

centuries until Ben Franklin let it out with a pass key, and since then it has been pulling off more new stunts than the Russian government. With it you can start a conversation or stop one perpetually, cook dinner, curl your hair, press your trousers, blow up a battleship, run an automobile, or signal Mars, and many more things are being invented.

"Like the price of rib roast, lightning seldom hits twice in the same place, but once it does hit there is little left." The Lord said, "Let there be light," and now all we must do is press the button."

## Navy Day Honor Roll

NAVY Day activity this year has outdone all previous years!! Many more stations have reported with message copies, and throughout all reports we find a feeling of good will toward our Uncle Sam and his Navy.

A word as to the method of grading reports will be interesting. In the East both NAA and W1MK were 100% copiable. Many near-perfect copies were turned in so that we had to scan very closely to detect errors. In the South conditions were not so good, although fair copy was turned in on both stations from this section. In the Middle West and South-west conditions were rather poor. QRM was found on both stations, with W1MK suffering more on account of being in the amateur band. In the far West daylight was still spread over the land. For these reasons special considerations had to be given to all sections of the country.

Some stations worked under irritating handicaps. A thunderstorm in Texas covered transmission from NAA. In the far West NAA was copied mostly on 12045 kc. (24.9 m.), which allowed Fords to provide QRM. One fellow found that his receiving tubes had gone bad just before the broadcast. He had to run down town to buy a new set.

Those who had logged NAA and W1MK previous to Navy Day got better copy than those who had to search for them. Some contestants believed that transmission from NAA overlapped transmission from W1MK, but such was not the case. NAA finished at very close to 7:59½ p.m., E. S. T., and W1MK started promptly at 8:00 p.m., E. S. T. NAA sent at a speed of about 19 w.p.m., and W1MK sent at a speed of about 14 w.p.m.

The fifty highest stations had copy that was very near to perfect, when all considerations are taken into account. W1BIG had the only perfect copy on both stations.

Just as last year, the Navy Day Honor Roll has been made up from copies of the broadcasts sent in to Headquarters. The following ten men stand at the top of the Honor Roll, and therefore will receive a letter of commendation from the Secretary of the Navy. They are arranged in the order of high scores.

- W1BIG—Frederick Best, Augusta, Maine.
- W6BJX—E. O. Knoch, Los Angeles, Calif.
- KGAR—M. W. Bannister, Tucson, Ariz.
- W8BKX—Wilbur C. Gross, Conneaut, Ohio.
- W9KV—Reed R. Brunner, Duluth, Minn.
- W5AL—C. F. Butcher, Greenville, Texas.
- K4KD—E. W. Mayer, Ensenada, Porto Rico.
- W9CSR—Gerald Lovins, Denver, Colo.
- W4UO—Robert A. Holbrook, Atlanta, Ga.
- W4TK—Robert H. Reid, Jacksonville, Fla.

The remaining 230 stations on the Honor Roll are here also listed in the order of high scores: W4RN, W9EVB, W6AM, W1CPC, W2TA, W1IO, W2BPQ, W3HL, W8DYH, W9FS, W7AJ, W2AGY, W8CMO, Bertram C. Felsburg, W1PY, W1CDX, W8ARO, W9ME, W8AEE-W9CXY, W5AQ, W5APG, W6UJ, W2BME, W1IT, W8ALK, W8CSS, W1RY, W1AJC, W8DED, W9BIB, Frank E. Romanosky, W9COS, Robert K. B. Saxon, W6AW, W2FW, W9CDE, W9CVE, W. Harvey Bowman, W8TJ, W1AUE, W1BLD, W2ASE-W2AFA-W8BDG, W1NK, W6KW, W9DWN, W9BBG, W6BZU, W2BIE, W2CRB, W8CLQ, W9CAF, W8DSP, W2CDM, W4FJ, W1BKT, Elmer R. Fritz, W9CNP, W9EGF-W9GCO, W9DPY, W5TV, W3AEL, W1SZ, W2ANM, W1PW, W3CEB, W1TA, W1KH, W9DLL, W9EEF, W9FQ, W7WU, W9ASV, W6BJF, W1LM, W8ARC, W8APN, W1COS, J. Russell Thorburn, W8RD, W1AOD, W1TP, W9EJW, W9CNY, W9BTX, W6EC, W8MC, W8CEO, W1BII, W1BGJ, C. F. Luscher, W1BED, W3AR, W1AMG, W3ALQ, W1ARU, W2AUP, W1ABE, W9CJO-W9FZB, W5FP, W5FJ, W9CA, W9DOE, W9GJ, W6EFA, W6RPC, W1BAQ, Leland C. Noel, W8FC, W2ANV, W9DTK, W8ARX, W1RNM, B. F. Greenia, W1MT, W9FL, W9DEK, W9EF, W6EEB,

W3AIS, W9MN, W9CVI, W1CAA, W2ANK, W1EW, W1EV, W9BBS, W5AMO, W9EGU, Lynn E. Axford, W8CVJ, W8DVO, W1BKS, W1RM, M. Fiole, W9ACU, W7ABH, William E. Cunningham, W8IF, W2BAQ, W2AJL, W8BAS, W9BPW, W8AUL, W2ALU, W9BNI, W9ERM, W1ANH, W4AGN, W8DSY, W8CNX, W8ANZ, W9FBO, W8BHD, W9AWX, W1BXH, W1BLM, W1AQL, W8AGQ, W9EJQ, W3WJ, W1BXA, W1BLX, W1AGC, W1AFL, W1HG, W1WZ, W2BJK, W8CZM, W2BKN, W2ABY, W1BKJ, W1BZJ, W1BLH, W8AKA, W8DYP, W9BCM, W8IE, W9ASX, V. D. Bust, W8JS, W2ACN, W8CY, W1BKQ, W3ATJ, W1JJ, W9BHR, W9ERM, W9BMU, W9EPX, William Lohr, W9BMU, W8AQU, W8QR, W8DCE, NJ2PA, W1NP, W8ZF, W3ADE, W2EV, W1WL, W3RQ, W1ACH, W8CMB, W1AP, W1KY, W3CFG, W1BFA, George Earl Speirs, W1VR, W1ALJ, W1BOB, W2AGQ, W1ATJ, W1JI, W1APK, W1ANI, W1ZAC, Wesley S. Blanchard, W8WJ, W3AWT, W8CNU, W1BST, W1FV, W1AVJ, W1CQ, W1AUR, W4GE, Francis W. Taylor, W1BFT, W4JO, W4DT. It is well to mention that one unsigned report was received, which, of course, will prevent proper credit being given it.

## The Navy Day Messages

MANY of the participants have suggested the inclusion of the texts of the Navy Day messages. These are given below as transmitted by NAA and W1MK. The copies reproduced herewith are not guaranteed to be letter perfect as to punctuation and preamble as these texts are not intended for checking of "copy" but for the general information of those interested.

From NAA :

To the radio amateurs of the United States from the Secretary of the Navy.

Today marks the seventh anniversary of the observance of Navy Day. This day is observed under the auspices of the navy league of the United States, with whom the navy cooperates to foster a better understanding of the navy by the American people.

The navy day message is similar to that of last year, viz, a navy adequate to support our commerce and a merchant marine commensurate with our sea-borne trade.

On this occasion it gives me pleasure to send the navy's greetings to you. Like the navy the amateurs are imbued with the spirit of service. This has been evidenced on more than one occasion during the past year. I have in mind the Vermont flood, San Francisquita Canyon flood in California and two West Indian hurricanes that caused heavy damage to life and property in this country. Be it flood, hurricane or other emergency that interrupts normal communication lanes the amateur stands ready to fill the gap, not to mention the communications between exploring and scientific expeditions and the homeland handled by amateurs.

Last year's message stressed the part the amateur played in the high frequency developments and in the advancement of the radio art in general. The field of radio is broadening every day. Radio is a necessity to aircraft. Television is already with us. I look to see the amateur continue to hold his place in the further advancement of the radio art.

Radio is vital to the navy both in peace and war. In war time however the navy's requirements for expert radio personnel are increased many times over those of peace time. The navy looks to you to form a large portion of its reserve of such experts. That great American Theodore Roosevelt the anniversary of whose birth falls on Navy Day, stated: "A nation should never fight unless forced to but it should always be ready to fight."

Many of you who are listening in tonight are in the Volunteer Naval Communication Reserve. I am proud of the record this branch of the reserve has made the past year. As for the coming year, I hope to see many more of you join the communication reserve before next Navy Day, with a view to improving your state of readiness should your country need you for a national emergency in the future. Many of the leading amateurs of the country are in the Naval Communication Reserve. Ask them about it. They will be glad to give you information.

I congratulate you all on your fine work in the past year and I will take a keen interest in your accomplishments during the coming year.

Curtis D. Wilbur

QST QST QST de W1MK W1MK W1MK. This is the day on which the President of the United States asks us to pause from our daily affairs long enough to give thought to our Navy. The American Radio Relay League needs no prompting on such an occasion. As President of the ARRL, it gives me the greatest satisfaction to take the key of our headquarters station and ask every radio amateur in our country to salute his United States Navy and give serious thought to what the Navy represents. In these modern days of rushing individualism we are prone to forget some of the foundation stones upon which we stand. Our Army at home and our Navy every where else are the physical embodiment of what our beloved Stars and Stripes symbolize. They mean our Nation, our United States of America. Unless our Nation is strong and steady and right our foundation stones crumble and individualism has nothing to stand upon. Our United States Navy has a hundred and fifty years of glorious record behind it during which time it has kept American foundation stones solid and firm. Let us not forget it. Let us as radio telegraph experts also realize that each one of us has a personal responsibility in the matter. The Navy depends upon us as a reserve in case of national emergency of any kind. It maintains a reserve organization for us. Many of us are enrolled in it. All of us ought to be in one reserve or the other, either the Army or the Navy. ARRL Headquarters will give you full information. Let this Navy Day be your inspiration to enroll in the Naval Reserve tomorrow.

Sig. Hiram Percy Maxim, Lt. Commander USNR  
President American Radio Relay League  
QST de W1MK HP VA

## Expeditions

### WFBT

There is little that we can add to the information on WFBT's schedules presented in these columns last month. Operator Berkner has been handling the bulk of his traffic from the Byrd expedition through W2ALU, W2KR, W2BRB, W2BFY, W8AHC and W9EDW. These stations have also been in communication with the other ships of the Byrd expedition. On November 5 the S. S. *City of New York* was 82 miles WSW of Tahiti bound for Wellington. A schedule with W9EGU (7094 kc.) has been added at 1250 GCT daily offering another reliable outlet for traffic for WFBT (8800 kc.).

### WSBS

The monthly message from "LJ" of the Yacht *Carnegie* of the Department of Terrestrial Magnetism brings us up to date. This message was sent November sixth shortly after the expedition shoved off from Panama. The *Carnegie* is due at the Easter Islands December 20 but will not get mail again until arriving at Callao, about January 29, 1929. A new three coil honeycomb receiver has been installed for medium and long wave reception. Operating time is limited to about two hours per day due to the pressure of other work. It is hoped that a series of interesting strength observations on various short wave stations can be started early next year. "LJ's" report follows:

"We arrived at Colon on the morning of October 11 and proceeded through the Canal to Balboa the same day. We remained here until October 25. WSBS was unable to operate during the whole two weeks in port as the ship was supplied for that period with 25 cycle a.c. and the transmitter could not be operated on that. The schedule with M1MK has been working EB as usual. WSBS now has one on Tuesdays and Thursdays with W8SZ. Hope to reestablish contact with W2XAU again soon. Calls worked: W1CEI, W1MK, W3SZ, W2HY, W3ANH, W2BFQ, W3AVL, W2CCD, W2BAV, and s12KW. We have had head winds most of the time since leaving Panama so we are not so far from there yet. Expect to cross the equator tonight. The weather is surprisingly cool and it has been rainy. Radio conditions and contacts have been uniformly fine. See you next month. 73.

L. A. Jones, Operator Yacht *Carnegie*."

W8COX of Cleveland keeps a schedule by radio- phone with W8HB, who is located five miles out in Lake Erie, at the Cleveland Waterworks' station. It seems that there is no news available at W8HB except through W8COX. The Waterworks' gang and the crews from tenders get quite a thrill out of hearing W8COX read the paper to them every evening.

The gang at Comanche, Texas, put on quite an attraction at the Comanche Round-Up. In their booth was the usual transmitter, operator, and message blanks for the free transmission of messages, which of itself was a good attraction. But the fellows, recognizing the "selling points" (to the public) of a radio transmitter, put the set through the antics of drawing sparks from the r.f. choke, lighting the frequency meter's bulb with the transmitter (power transmission by radio!!!), and pointing out the mercury arc's ghost-like glow. Crowds never failed to show an interest.

The transmitter (W5HF) employed only one UX210. The aerial was hitched to a flagpole. Twenty-four hour operation was the rule, and messages were handled even for Scotland (it was free) and Egypt.

FTJU is a ship in the north Pacific on about 7390 kc. (88 m.)

### Forty-Eight Hours

The common stipulation that every ORS relay each message within forty-eight hours or, failing to do so, that he mail the message in order to insure its delivery, has been the cause of much local passing about of inter-continent traffic. In order to avoid this, W2BGO sent in the suggestion which has led to the following provision which will be found in the new Rules and Regulations:

"Messages for all continents *except* North America may be held one-half the length of time it would take them to reach their destination by mail . . ."

An instance of worth while traffic work recently was called to our attention. W3ATJ in Mount Holly, N. J., handed a message for a gentleman in Philadelphia who had been trying all day to get a message of the gravest importance through to Chicago. We want to see more of this kind of work.

Christen Syverud is the second op aboard AQE, the famous whaling vessel that is now in the Ross Ocean hunting the well-known cetaceous mammals. Both the chief op and his assistant are members of the League and invite QSO.

Cliff Himoe, operator of WNP, is getting acquainted with the gang all over again by taking a trip in one of Henry's new creations to the west coast. Portable W1ZBZ helps to make the trip more interesting.

In connection with the Marathon Swim around Alameda Island recently, W6JS, W6CKC, and W6RJ installed a set on a fast speedboat and reported the race to KTAB. Excellent work, OM's!!

Another snappy bit of work that comes to our attention was done by W3CHG. A Marine in Nicaragua learned of his father's death and wanted to come home. Not having enough money, he asked un7NIC to help him out. W3CHG got the message, told the Marine's mother, with the result that the money arrived the next day. FB!

The Los Angeles Radio Show Beautiful was well represented by amateur radio in a booth constructed and manned by local amateurs. Thousands of messages were handled to all parts of the world.

Among Alaskan schedules, the most efficient one we have had brought to our notice is that of W7TX, who keeps three a day during the canning season with K7EL, K7AER, and K7ABE. FB, John!!



# VOQ Contact

By Felix E. Batt, VE5GT

THE expedition from the American Museum of Natural History chose as its main objective in 1928, the quest of existing remains of ancient civilizations in the far Aleutian Islands. The party was under the co-leadership of Mr. H. Stoll and Mr. Harold McCracken and was consequently called the Stoll-McCracken Expeditionary Party. The expedition was very successful in its venture, bringing back several excellent specimens of mummified bodies as well as much other "evidence" calculated to establish the "missing link" between Asiatic and North American civilization. Besides this, the party had the good fortune to bag lots of walrus, and secured much valuable data on bird and animal life.

Prince Rupert, the largest city on the northern coast of Canada, was selected as the starting point. On the third day of May the ship *Effie M. Morrissey* of VOQ fame, set sail from Prince Rupert, B. C., with Captain Bob Bartlett at the helm and Ed. Manley at the key of VOQ.

Before the *Morrissey* had left port I had succeeded in squeezing in a tri-weekly schedule between VOQ and VE5GT (then nc5GT), but I did not hold much hope for this since Manley had so many others. However, it turned out better than my wildest expectations because Manley was soon asking for more (hi)! I stuck with the "sked" for fourteen days before I even heard VOQ. It was just when I had begun to despair of ever hearing the *Morrissey* that success came. On May 14, VE5GT worked VOQ off the Shumagin Islands in the Gulf of Alaska. Due to heavy seas, communication was not very satisfactory. Nevertheless, it was the first contact and that was what counted. Before this I had received a radiogram through nu6JU who handled one of VOQ's main schedules informing me that I had not been heard but to keep on trying. This I did with ultimate success.

From that time on, traffic moved with increasing volume and regularity. We kept up the schedule, with some breaks of course, right to the end of the voyage. Our first schedule was at 7 pm PST. As the days grew longer the hour was advanced until it reached midnight—and then two-thirty in the morning. We made our schedules at the times when signals were best because that meant a maximum possibility of getting the traffic through. There were months when the signals were never more than QSA3. They were often poor and with QRM. QRN, and sometimes varying frequency (QSX) due to motion of the ship the work became difficult. Hours were required to get some of the messages through. Only through long waiting for improvement in transmitting conditions and by exercise of much perseverance was so much accomplished.

I remember the first bit of real traffic handled. Signals were poor, QRN heavy. It was necessary to couple the transmitting antenna to the receiver to broaden the tuning to make VOQ's signals (which were swinging fiercely) copiable. The *Morrissey* was bucking heavy seas. With the set tuned to the limit, every nerve was keyed up to the final pitch and I scratched away desperately with my body tense, sometimes getting whole words, sometimes receiving only parts. After it was all over my body went limp and perspiration broke over my forehead as I relaxed in the chair.

When there was no traffic to be sent and signals were fair, I often sent *New York Times* press to Manley who was unable to copy it direct for long periods. Toward the end we stood by taking traffic from the *Times* and relaying it direct to Manley a few minutes after. There was one thing that the party felt the need of more than anything else and that was news. I did my best to fill the gap. Another station that did a lot of real amateur work was K7HL (then na7HL) at Taku Harbor, Alaska. K7HL had the advantage of more power and thus kicked through better than we did at times. K7HL used to pass along traffic from the *Sun Francisco Examiner* to VOQ, most of this traffic originating of the *Times*' station. Sometimes we were able to forward the messages direct 24 hours ahead of this routing, thereby adding a notch to our gun.

My friends used to think me rather queer when I would leave a party, or insist on being home from a boat ride, or perhaps run hot foot out of a cafe to talk to the *Morrissey*. As observed in Heiser's

account of last year (March 1928 *QST*, C. D. page 1) these people would wonder what possible incentive there could be for shutting myself into a red hot room in mid-summer to "listen to the radio". As W8DME said, "Ask any real ham". Although I am not married (and see no prospects for a while yet—hi), I think a single fellow has just as many ties to hold him away from a thing like this. At any rate, I held down all my schedules excepting one 2.30 "sked" when I fell asleep at two a.m. and never knew a thing until five a.m. Lots of times I have turned out the light while making the log entry, and kept on writing by daylight. Altogether I lost about two hundred hours of good sleep in five months—and I'll say it was well worth it.

Toward the middle of the summer it got to be a regular habit for the Canadian National Telegraph messenger to come over to my place of work with a fist-full of messages for the *Morrissey*. The operator always used to phone me before clearing his wire for the night to see if we had any more traffic for him. On days when bad weather prevented contact, the town would beseech us for news from the Stoll-McCracken expedition. A couple of nice messages from KDCGN were handled on one occasion when KDCGN worked VOQ but was unable to get in touch with its base in Oregon.

The 7,000 kc. band was used exclusively at VE5GT while Manley seldom worked on any other than his 9370 kc. (32-meter) frequency. VOQ was heard on eighty schedules and worked seventy-four times. Over 11,000 words were handled, these in 194 messages (69 sent, 125 received). Only about 16% of the traffic received was press. In the file of messages sent is one originated at London, England, and filed by cable.

VE5GT used a T.G.T.P. rig, two 852's in parallel with 1,000 volts on the plates supplied by an Esco M. G. On account of the reduced plate voltage the two tubes were run in this manner giving us about the output of a single 852 at full voltage. The two tubes ran very cool over the long periods of operation necessary. The plate input averaged about 135 watts. The antenna was a two-wire voltage-fed (Zeppelin) type. The portable, VE5GU, battery operated, was used by operator Pete Davies and gave a good account of itself. I have to acknowledge the valuable assistance rendered at VE5GT by operator Davies as well as that of N. Kinslor, the station's constructor, without whom I would have found it very hard at times.

Near the end of the journey, as VOQ was nearing port, I was on the job at noon and six p.m. as well as later in the evening. I had to rush from work to the scene of operations and back again taking my lunch with me and gulping it down between the dots. At the time I furnished Captain Bartlett with the weather, obtained from the meteorological station at Prince Rupert.

Before the *Morrissey* arrived, Mrs. Jacques, wife of the artist aboard ship came from New York to Prince Rupert to meet her husband. VE5GT was the medium of a successful preliminary reunion of husband and wife which was accompanied by quite an intense scene. The public has not yet gotten over the idea that messages received by amateur radio are not sent broadcast to every h/c set owner in the country. Mrs. Jacques in particular was at first horrified to think that her husband's "sweet nothings" were being broadcast all over the world. I think very highly of Mr. and Mrs. Jacques and her mother. They are wonderful people.

As the *Morrissey* came up the harbor that clear, cold, starry night in mid-October we held contact until the time the expeditioners could see the lights of the city. Taking the last message sent by radio from the party we dashed to the telegraph office, phoned the proper authorities, and rushed out to meet the expedition in our own boat, the VE5GT-1. Meeting them about an hour out, we accompanied the ship to her berth. I shall never forget the sight of the ship as she slid through the night like a great Arctic spectre, and the docking of that famous ship amid the cheers from the land.

Like W8DME, we also have received many letters of appreciation from people who have depended on us practically as their only means of communication with the outside world. It is gratifying to receive such letters, and they mean much to fellows like us

## ELECTION NOTICE

who do not receive anything from a venture of this kind besides experience. I am carefully preserving all records connected with the expedition as valuable souvenirs. In days to come we can look back on these with pride. Mr. McCracken announced just before he left that VE5GT was the winner of the fully mounted magnificent walrus head as a token of appreciation for the good services rendered the expedition by our station. This will be the most prized possession of all. It is hoped VE5GT's performance will put the station in line for the H-tube, offered by W8DME, also. This is the second time a Prince Rupert amateur station has come into the limelight for its work with Arctic expeditions. The excellent work of Jack Barnsley, nc9BP, with Don Mix, then operating WNP, will long be remembered.

All this is just another link forged in the long chain of worthwhile accomplishments that amateur radio is building up throughout the world. As the years go by the amateur is becoming more and more an ever growing necessity to the welfare of expeditions and nations.

To All A.R.R.L. Members residing in the Sections listed below: (The list gives the Sections, closing date for receipt of nominating petitions for Section Manager, the name of the present incumbent and the date of expiration of his term of office.) This notice supersedes previous notices.

In cases where no valid nominating petitions have been received from A.R.R.L. Members residing in the different Sections in response to our previous notices, the closing dates for receipt of nominating petitions are set ahead to the dates given herewith. In the absence of nominating petitions from Members of a Section, the present incumbent continues to hold his official position and carry on the work of the Section subject, of course, to the filing of proper nominating petitions and the holding of an election by ballot or as may be necessary.

## Wanted!

**M**ORE volunteer transmitting stations are needed to broadcast code practice for the beginners' program that we are conducting. Approximately 500 beginners have responded to our recent notices in QST. Our supply of mimeographed material, exhausted by such a demand, will be revised and reprinted. Before this happens we shall need more reliable transmitters over the whole country.

The requisities are briefly, that you have a good station and that you be willing to spend several hours each week transmitting code practice in the 160 meter band. Radiophone stations particularly are suitable for this work; we have several of them enlisted already.

If you feel that you would like to do some good work for the A.R.R.L., and if you are equipped to do it, kindly drop us a line giving the schedule that you propose to follow.

Two new volunteers are to be added, with their schedules:

**FRIDAY:**  
W8ASW (1820 kc.) 10:30 to 11:15 p.m., E.S.T.

**SATURDAY:**  
W8ASW (1820 kc.) 10:30 to 11:15 p.m. E.S.T.

**SUNDAY:**  
W3AEQ (1750 kc. band) 1:00 p.m., E.S.T.

If you're looking for code practice near the 7000 kc. (40 m.) band, it would be well to listen for GBR on 8103 kc. (37 m.). This station sends the British Official Press starting at 7:00 p.m., E.S.T. A five minute break occurs at 7:15 p.m., after which the broadcast continues until approximately 7:30 p.m., E.S.T.

## Official Broadcasting Stations

### Changes and Additions

(Local Standard Time)

WIANI, 3620 kc. (82.9 m.) 6:50 pm daily except Sat. and Sun.; W1AQL, 3500 kc. (80 m.) Mon., Wed., Fri. 7:30 pm.; W1CDX, 3940 kc. (80 m.) Tues., Thurs., Sat., 7:15 pm.; W1AUR, 4000 kc. (80 m.) Tues., Fri., Sun. 8:00 pm.; W1AJC, 7110 kc. (40 m.) Tues., Thurs., Sat., 6:00 pm.; W3QP, 3660 kc. (82 m.) 7:15 pm. Tues., Thurs.; W6AMM, 7315 kc. (41 m.) 6:45 pm. Tues., Thurs.; W6BWS, 7130 kc. (42 m.) 7:30 am. daily; W8AGQ 7930 kc. (37.8 m.) daily except Sat. and Sun. 11:30 am., W9CJQ, 3705 kc. (81 m.) 7:30 pm Mon. Wed. Fri.; W9CZC, 3945 kc. (78 m.) 7 pm Tues. (sometimes Thurs.); WRJN-W9BJW, 1200 kc. (250 m.) 1:00 and 7:30 pm Mon. Wed. Fri.; VE4DB, 7500 kc. (40 m.) 9 pm Mon.; VE4DP, 15,380 kc. (19.5 m.) 8:30 pm Wed.; VE4FV, 7950 kc. (37.7 m.) 9:30 am Sun.; VE4FN, 7790 kc. (38.5 m.) 8:30 pm Wed.

Section	Closing date for petitions specified of the present year on or before noon of the dates	Present SCM	Present term of office ends (1928)
Western N.Y.	Dec. 20	C. S. Taylor, W8PJ	July 1
Louisiana	Dec. 20	C. A. Fietlag, W5UK	Oct. 2
Nevada	Dec. 20	C. B. Newcomb, W6UO	W6UO
West Virginia	Dec. 20		Sept. 15.
Alabama	Dec. 20	C. S. Hoffman, W8HD	Aug. 2
Philippines	Nov. 28	A. D. Trum, W5AJF	July 1
Southern Minnesota	Dec. 20	Jose E. Jimenez, 6PIAT	Dec. 31
Virginia	Dec. 20		Acting
Arizona	Dec. 20	D. F. Cottam, W8RYA	Nov. 27
Ca.-S.C.-Cuba-P.R.-Iale of Pines	Dec. 20	J. F. Wohlford, W8CA	Dec. 2
San Francisco	Dec. 20	D. B. Lamb, W5ANO	Dec. 2
		H. L. Reid, W4KU	Aug. 2
		J. W. Patterson, W6VR	(resigned)

### Newfoundland and Canada

Nominating petitions for Section Managers in Newfoundland and Canada should be addressed to Canadian General Manager, A. H. Keith Russell, VE9AL, 5 Main Building, Toronto, Ont., Canada. To be valid, petitions must be filed with him on or before the closing dates named.

Newfoundland	Dec. 20	Loyal Reid, VE5AR	July 13
New Brunswick	Dec. 20	T. H. Lacey, VE16I	Aug. 2
Nova Scotia	Dec. 20	F. C. Borrett, VE1DD	Aug. 2
P.E.I.	Dec. 20	F. W. Hyndman, VE1BZ	Aug. 2
British Columbia	Dec. 20		Aug. 2
Saskatchewan	Dec. 20	E. S. Brooks, VE5BJ	Dec. 2
		W. J. Pickering, VE4FC	Dec. 2

Due to the resignation of Mr. Patterson, W6VR, in the San Francisco Section of the Pacific Division, effective at once, nominating petitions are hereby solicited for the office of Section Communications Manager, and the closing date for receipt of nominations at A.R.R.L. Headquarters in Hartford is herewith specified as noon, December 20, 1928.

1. You are hereby notified that an election for an A.R.R.L. Section Communications Manager, for the next two-year term of office is about to be held in each of these Sections in accordance with the provisions of By-laws 5, 6, 7 and 8.

2. The elections will take place in the different Sections immediately after the closing date for receipt of nominating petitions as given opposite the different Sections. The Ballots mailed from Headquarters will list the names of all eligible candidates nominated for the position by A.R.R.L. members residing in the Sections concerned.

3. Nominating petitions from the Sections named are hereby solicited. Five or more A.R.R.L. members residing in any Section have the privilege of nominating any member of the League in their Section as candidate for Section Manager. The following form for nomination is suggested:

(Place and date)

Communications Manager, A.R.R.L.  
1711 Park St., Hartford, Conn.

We, the undersigned members of the A.R.R.L. residing in the.....Section of the.....Division hereby nominate.....as candidate for Section Communications Manager for this Section for the next two-year term of office.

(Five or more signatures of A.R.R.L. members are required.)

The candidate and five or more signers must be League members in good standing or the petition will be thrown out as invalid. The complete name, address, and station call of the candidate should be included. All such petitions must be filed at the headquarters office of the League in Hartford, Conn., by noon of the closing date given for receipt of

nominating petitions. There is no limit on the number of petitions that may be filed, but no member shall sign more than one such petition.

4. Members are urged to take initiative immediately, filing petitions for the officials of each Section listed above. This is your opportunity to put the man of your choice in office to carry on the work of the organization in your Section.

—P. E. Handy, Communications Manager.

### ELECTION RESULTS

Valid petitions nominating a single candidate as Section Manager were filed in a number of Sections on or before the closing dates that had been announced for receipt of such petitions. As provided by our Constitution and By-Laws, when but one candidate is named in one or more valid nominating petitions, this candidate shall be declared elected. Accordingly election certificates have been mailed to the following officials: (These officials will welcome your monthly activity reports.)

Section	Address	2-year Term begins
Northern Minnesota	Carl L. Jabs, W9BVH, 1822 James St., St. Paul	Oct. 20
Colorado	C. R. Stedman, W9CAA, 1641 Albion St., Denver	Oct. 20
Ontario	E. C. Thompson, VE3FC, 206 Queensdale Ave., Toronto	Oct. 20

In the Rhode Island Section of the New England Division, Mr. R. S. Brown, W1AAL, and Mr. C. N. Kraus, W1BCR, 92 Keene St., Providence, R. I. were nominated. Election results: Mr. Brown, 18; Mr. Kraus, 32. Mr. Kraus therefore has been declared elected, his term of office beginning October 31.

As usual amateur radio was called upon to play a part in the handling of election returns in the recent national election. New Ashford, Massachusetts, a town in the heart of the Berkshires, for the fourth time was the first in the United States to complete its vote earlier than any other place in the entire country. Two amateurs, Prentiss Bailey, operating W1BGD, and Walter Groves of W1AXW at Pittsfield, Mass. flashed the count to The Berkshire Eagle and the Associated Press at 6.34 a.m., as soon as the count had been completed. The vote was said to be the earliest ever tabulated and reported in a presidential election. Both accuracy and speed were essential in putting over this nice bit of amateur communication work.

### ARMY-AMATEUR NOTES

**SECOND CORPS AREA—W2SC**, the Corps Area Net Control Station, is on the air every night on 3855 kc. (77.2 m.) and is always ready for traffic of any nature, whether Army-Amateur or general.

**Western New York State Net:** W8DME has resumed the weekly net schedules that W8AHC formerly kept with W2SC. W8AHC is married now but will resume his A-A work in a short time. W8AFG, W8CVJ, and W8BFG are the active stations in the State Net.

**Eastern New York State Net:** W2KR has been busy lining up the various county Net Control Stations. The Net is functioning in fine shape. W2ANV is assisting in the organizing of the up-state counties; and W2BGB is the New N.C.S. for Albany County. More A-A stations are needed in this locality. Interested stations should send their QSL cards to W2PF, W2AND, W2JA, W2ALP, W2BCO, W2AJL and W2CZR continue as the active stations in their respective nets.

**New Jersey State Net:** W2AOS is acting N. C. S. of the state owing to the temporary absence of W2CP and W2JG. W3ATJ is the new N. C. S. of Burlington County. The time of the Net schedule has been changed to 11:30 p.m., E. S. T., on Monday nights. The monthly Army-Amateur A. R. R. L. meeting held at the Army Building, 39 Whitehall St., New York City, on the first Monday of each month have proved to be a great success. Over 300 amateurs attended the October meeting and even more are expected at the November meeting. Colonel Allison, the Signal Officer of the Second Corps Area, will be present and there will be a demonstration of Signal Corps short wave equipment.

### BRASS POUNDERS' LEAGUE

Call	Orig.	Del.	Rel.	Total
W8CHC	422	103	750	1275
op1HR	186	176	629	994
W6AMM	185	365	36	586
W1MK	80	113	261	454
W9BEQ	375	14	32	421
W8MQ	29	17	340	386
W6AJM	34	2	340	376
W5AIN	88	56	216	360
W8DBM	81	22	240	343
W1AUF	328			328
W9DWN	6	10	300	316
W1AMG	51	33	222	306
W9DEA	32	24	215	271
W8AVK	18	21	228	267
W3AKB	9	40	217	266
W1AFB	13	17	234	264
W7AAT-QT	56	4	196	256
W1IP	33	9	211	253
W9EDW	5	7	240	252
K4AAN	131	11	109	251
W8MQ	8	8	225	241
W2ALU	45	135	60	240
W9DGW	4	8	228	240
W6EC	40	6	186	234
W9AYK	116	8	108	232
W1AKS	28	13	186	227
W6BZR	2	8	216	226
W8AHC	22	120	82	224
W8CMB	30	54	140	224
W6ZBJ	6	2	206	214
W8DED	49	28	130	207
W2BFF	26	47	133	206
W8DSP	46	29	116	201
W1AUR	42	37	119	198
W2APV	52	116	5	173
W3ZF	36	90	39	165
W2KR	12	85	47	144
W1WV	33	57	53	143
W9BCA	18	54	66	138
W8ARX	10	50	56	116
W6RAS	29	58	—	87
W6BYZ	17	63	—	80
W2BRB	16	62	—	78
W8CLQ	5	58	1	64

W8CHC holds first place in the ranks of our B.P.L. in spite of heavier traffic at op1HR and W6AMM which moved them up to the head of the list. These three stations head our list for outstanding meritorious performance.

All these stations appearing in the Brass Pounders' League are noted for their consistent schedule-keeping and reliable message-handling work in amateur radio. Special credit should be given the following stations responsible for over one hundred DELIVERIES in the message month: W6AMM, op1HR, W2ALU, W8AHC, W2APV, W1MK, W8CHC. Deliveries count!

A total of 200 or more bona fide messages handled and counted in accordance with A.R. R.L. practice, or just 50 or more deliveries will put you in line for a place in the B.P.L. Why not make more schedules with the reliable stations you hear and take steps to handle the traffic that will qualify you for B.P.L. membership also!

W6DZL extracted the following travesty on the 23d psalm from *World Wide Wireless*:

### THE PSALM OF RADIO

Radio is my hobby; I shall want no other.  
It maketh me to stay home at night,  
It leadeth me into much trouble.  
It draweth on my purse—  
I go into paths of debt for its name's sake.  
Yea, though I understand it perfectly, it will not oscillate.  
The different kinds of notes—they comfort me;  
Yet it will not work in the presence of mine enemies.  
I anoint the coils with shellac,  
But the tube spilleth over.  
Surely the radio bug won't follow me all the days of my life,  
For if it does I will dwell in the House of Poverty forever.

# W1MK

A. R. R. L. Headquarters Station W1MK operates on frequencies of 3575 kc. and 7150 kc. Robert B. Parmenter, "RP," is chief operator. His "fist" is familiar to most of the amateur fraternity. Other members of the Headquarters staff use the personal "sines" listed in the QRA section of this issue when operating the Headquarters Station.

Throughout this notice the times given are 75th meridian time, otherwise referred to as Eastern Standard Time or "Zone plus 5" time.

All the latest official and special broadcasts are sent simultaneously on 3575 kc. and 7150 kc. at the following times:

8:00 p.m.: Sun., Mon., Tues., Thurs., and Friday.  
10:00 p.m.: Monday and Friday.

12:00 p.m. (midnight): Sun., Tues., and Thursday.

Periods of GENERAL OPERATION have been arranged to allow everyone who may desire to do so to communicate with Hq. These general periods follow transmission of the official broadcast messages usually. They are listed below under 8500 kc. and 7000 kc. headings depending whether the watch is devoted to listening on the 80- or 40-meter bands. 7000 kc.—

8:10 p.m. to 9:00 p.m. on Sun., Mon., Tues., Thurs., and Fri.

10:00 p.m. to 11:00 p.m. on Tues. and Thurs. (No official broadcast is sent preceding these.)

12:00 p.m. to 1:00 a.m. or later on Sunday night (Monday a.m.).  
7000 kc.—

10:10 p.m. to 11:00 p.m. on Sun., Mon., and Fri.

12:00 p.m. to 1:00 a.m. on the following nights (actually the morning of the day following): Mon., Tues., Thurs., and Fri. Only on Tues. and Thurs. does the official broadcast precede this period.

Traffic to and from Headquarters will travel quickly through any one of the following stations with which regular schedules are kept.

3500 kc.: W1ACH, Brookline, Mass.; W1BIG, Augusta, Maine; W1BQD, Newport R.I.; W1KY, Cambridge, Mass.; W1VB, Newtown, Conn.; W2JF, Jersey City, N. J.; W2SC, Woods Island, New York Harbor; W3QP, Philadelphia, Pa.; W3ZF, Philadelphia, Pa.; W3ZS, St. Davids, Pa.; W3AAG, Oil City, Pa.; W8AYB, Buffalo, N. Y.; W8BYN, Columbus, Ohio; W8DED, Holland, Mich.; W8ZZ, Detroit, Mich.; W9APY, near 7000 kc. band), Berwyn, Ill.; W9OX, Louisville, Ky.; VE8AL (on 5720 kc.), Toronto, Ont.  
7000 kc.: W5AYB, Muskogee, Okla.; W5JC, San Antonio, Texas; W6BMW, San Jose, Calif.; W6WB, San Francisco, Calif.; W6ZD, Berkeley, Calif.; W7TX, Seattle, Wash.; W9BCA, Ft. Madison, Iowa; W9BLL, Alton, Ill. (St. Louis traffic); W9DWS, Kansas City, Kansas; W9XI, Minneapolis, Minn.; VE2BR, Pointe Claire, Que.; n2PA, Port Antonio, Jamaica, B. W. I. (European traffic); WFBT, S. S. City of New York; WSBS, Yacht Carnegie.

## TRAFFIC BRIEFS

Recently the Los Angeles made a trip from Lakehurst, N. J., to the helium plant at Fort Worth, Texas. The Navy Department had no radio installation at the latter place, and therefore called on amateur radiomen. W5AVS's transmitter, consisting of an UX-852 on 7900 kc. (38 m.) was moved to the helium plant and put into operation prior to the time the Los Angeles left Lakehurst.

Communication was consistent throughout the trip down, with NERM (the Los Angeles working on 2490 kc. (86 m.). W5AVS was operated in shifts by W6WZ, W5AVS, Gordon Carl White, E. M. Frost, and Karl Kilander. The following report was given to the Navy Department upon the return of Los Angeles, by the Commanding Officer:

"5AVS, an improvised amateur station at the mast at Fort Worth, rendered especially valuable and satisfactory service. It is recommended that this station be thanked in some suitable manner by the Department for their conscientious and untiring efforts during the flight, and their excellent spirit of co-operation."

Although Naval stations ordinarily can not work amateur stations promiscuously, a special order authorized communication of NERM with W5AVS. This is another sample of what can be done by amateurs to help Uncle Sam. Good work, fellows!!

These three- and four-element things that are instrumental in getting signals into and out of the air have been called tubes, valves, bottles, and jugs. We found a new name the other day in a report from VE3FC. He wanted to call 'em lanterns. Another one for the book, Noah!

In 1929 the problem of increased selectivity on receivers will be very important. Did you know that even two stations operating on exactly the same frequency can be separated if the proper method is used?

Doc Woodruff, W8CMP, has the dope and explained it to the gang at the West Gulf Division convention. It's simply to make the receiver PORTABLE!! Have you heard of Doppler's Principle? Of course you've noticed, when standing by the track as Number 17 flew by, how the pitch of the whistle changed the instant the locomotive passed you. That's it: the pitch of approaching sounds is higher than that of receding sounds.

In the same way, if your receiver is moving toward a transmitting radio station, the relative rate of the arriving radio waves is of course higher than when the receiver is at a fixed location or is moving away from the transmitter. Suppose W9XXX has a portable receiver and, finding the W1XXX and W6XXX are transmitting on exactly the same frequency, he hitches his wagon to a star and begins cruising toward W1XXX. As W9XXX moves, W1XXX climbs up on the dial while W6XXX moves down on the dial. By regulating the speed of the star, W9XXX can separate the two interfering stations with a nicety known only in dreams. (Alas!!)

Doc also points out that it is possible to abandon loops as direction-finders. Suppose that W9XXX is W9DUMB and does not know that the first inspection district is east and the sixth inspection district is west. He wants to find their true bearing from his location, so he cruises in a circle, noting that when he is moving in a north-to-south direction the signals arrive at dial settings identical with those obtained when his star is stationary. Ergo: the transmitters, W1XXX and W6XXX, lie at right angles to his path or east and west from W9DUMB.

Further applying Doppler's Principle, it is evident that plug-in coils are not necessary. Merely regulate the speed of the star either to or from the incoming signal, thus changing the frequency. The principle is OK—no kidding!!!

W2RYO was racing against time the other day to keep his schedule on the Twentieth Century Limited traffic route. The Stutz was going ninety miles per hour when suddenly everything went blank. One man died and we understand that the schedule from W2BYO that night had to be postponed.

Contacts between the United States and Canada would be much more numerous if U. S. amateurs would listen on the exclusive Canadian amateur band—5720 kc. (52.5 m.). VE3CJ, Canada's Route Manager, tells us that from seven p.m. (E. S. T.) until midnight or later there are Canadians on 5720 kc. who are eager to work U. S. amateurs who are on either 7000 kc. (40 m.) or 3500 kc. (80 m.). The Canadians, after calling CQ on 5720 kc., will indicate on which band they will listen in this fashion: KA CQ CQ CQ de VE3CJ VE3CJ VE3CJ 3500 AR.

Let's get on to this 5720 kc. frequency with our receivers and handle more Canadian traffic, fellows. If your receiver can not tune to 5720 kc., a new plug-in coil can be made to cover that band. Or, if you want to find the band more quickly, you can shunt your 7000 kc. receiving coil with a variable condenser, thus adding capacity which will raise the period of the circuit to a point where WLW's high frequency radiophone broadcast comes in. When this point is found, the added variable condenser should be "fixed." As WLW's high frequency transmitter is found just above (in kilocycles) and just below (in wave-length) the Canadian 5720 kc. band, you will have no trouble finding the spot.

SWGL is an Athenian ship, *Niritos*, and has worked W8CCL on the 14,000 kc. band.

W1MK will not operate on Christmas Day. This station will operate as usual Tuesday night, Jan. 1, 1929.

# DIVISIONAL REPORTS

## ATLANTIC DIVISION

**S**OUTHERN NEW JERSEY—SCM, M. J. Lotysh, W3CFG—First place continues to be monopolized by W3CFG. W3ATJ turned in first report as an ORS. W3BWJ promises some schedules. W3ARR turned in his initial report and expects to do better in the future. W3IV moved to New York. Appointments of W3CO, W3OQ and W2IS have been cancelled. Some of our prominent ORS are due for a buggy ride this month. To eliminate the hangers-on who habitually report no traffic, a monthly minimum of 5 messages will be effective Jan. 1. Any station that cannot get on the air five nights per month and average one message per night ought to be ashamed to keep their certificate. If you want to keep in the swim, come across with the goods.

Traffic: W3CFG 78, W3ATJ 7, W3BWJ 6.

**MD-DEL-D. of C.**—SCM, Dr. H. H. Layton, W3AIS—Maryland: W3APX at Annapolis will be on shortly with a 50 watter. W3TR also at Annapolis reports that W3RQ is perking on 7000 kc. W3CGC sends in a good traffic total. W3BBW was also on the job. Delaware: W3AJH shook the YL and is once more burning the midnight oil on 7350 kc. W3ALQ shouts his head off on phone when not moving traffic on 7500 kc. W3AIS has a fifty watter perking. Dist. of Columbia: W3GT at Bolling Field and W2AF sent and received messages both ways between Washington and New York on speed test, beating Western Union by one minute. W3BWT will soon be back on the air with a brand new antenna. W3AHP reports a new 100 watt set soon to go into action. W3ASO is active in Washington.

Traffic: Md. W3APX 6, W3BBW 43, W3CGC 96. Del. W3AJH 8, W3ALQ 2, W3AIS 6. D. C. W3AHP 39, W3ASO 16, W3GT 69.

**WESTERN NEW YORK**—SCM, C. S. Taylor, W3PJ—Well, gang the bunch are still at it handling traffic with a few more additions to our midst. W3BHA and W3CHG are coming to the front. W3ABX is working again. W3AHC has over 200 messages to his credit this month and a couple of schedules. W3AKZ is back with traffic. W3ARK makes the BPL this month on deliveries. W3AVS reports traffic. W3BBP starts off handling traffic and schedules. W3BCM is QRW with school. W3BFG has a new screen grid receiver. W3BHA and W3BHK are handling traffic. W3BLP is handling traffic. W3BJO is another new one to our list. W3BLY and W3RMJ are after traffic. W3BQK has a few to report this month. W3BUP expects to be on steady now. W3CDB expects big things. W3CNT got message from RK-702, Lemingrad, Russia. W3CNX states things are going good. W3CPC is pushing his traffic up again after a few months stay in Europe. W3CSW blew his 50 watter. W3CVJ wins the booby prize with just one message. W3DFW has been working on 14,000 kc. most of the time. W3DII makes the BPL again. W3DME has schedules with several stations. He also states that W3AHC works the Byrd expedition every morning. W3DQP lost his sky wire. W3DSP's new QRA is Syracuse. W3DUP is another addition to our gang at Martinsville, N. Y. W3FC is another addition. W3GQ has busted loose again. W3TH managed to put over a few boy scout messages. W3EDA, P. O. Box 10, Corbyville, Canada, wants schedule with W3's. Those who want schedules please write W3AYB. Mr. Harry Frost, 33 Huesey Ave., Buffalo, N. Y.

Traffic: W3ABX 5, W3AHC 224, W3AKZ 21, W3ARX 116, W3AVS 15, W3BBP 60, W3BCM 17, W3BFG 4, W3BHA 37, W3BHK 15, W3BLP 5, W3BJO 71, W3BLV 13, W3BMJ 29, W3BQK 4, W3BUP 7, W3CDB 48, W3CNT 77, W3CNX 82, W3CPC 31, W3CSW 20, W3CVJ 1, W3DFW 16, W3DII 142, W3DME 13, W3DSP 201, W3DUP 23, W3FC 61, W3GQ 2, W3TH 7.

**WESTERN PENNSYLVANIA**—SCM, A. W. McAulry, W3CEO—W3CHC, a new ORS, leads the procession this month with one of the largest totals this section has ever had. W3CHC is also an OO. W3XE is back on the air with tubes loaned them by the General Elec. Co. W3BGW is an active reliable station. W3CEO is using a remote controlled transmitter working on a rigid copper tube antenna. W3RHW was OSO DFAL, the Norwegian Motorship "Markand" while it was at Barcelona. W3CNZ has another new job. W3CFR says that his old reliable

sked sb1AW left for the USA. He is trying to land a sked with sb1AT. W3AMU is back on the air regularly after a spell of sickness. W3ABW was on for a nice total this month. W3AGO is on the road much of the time. W3AGQ is now operating regularly. W3ARC is on occasion. W3AYH is overhauling his transmitter. The Erie Amateur Radio Club held a banquet at the local yacht club Oct. 13 at which several of the West. Pa. hams in that city took part. The Amateur Transmitters' Assn. of Western Pa. has nearly a hundred members. Some of the fellows have written that they have not reported on account of not having the report card. Report on a piece of wrapping paper if you can't find anything else, but REPORT.

A late report from the Erie Amateur Radio Club correcting the call of the president of the club to W3BVG and not as printed in Oct. QST'. Also, some notes on individuals: W3DOB has a RAC power supply on his 3500 kc. phone. W3GU is attending college in NYC according to reports. W3BVG has a 1929 transmitter on the test board at his shack: W3LS has disposed of his transmitter and will devote his time at W3AMA.

Traffic: W3CHC 1275, W3XE 198, W3BGW 139, W3CEO 83, W3DHW 52, W3CNZ 36, W3CFR 33, W3AMU 25, W3ABW 25, W3AGO 18, W3AGQ 6, W3ARC 3.

**EASTERN PENNSYLVANIA**—SCM, J. B. Morgan, 2nd, W3QP—Sixteen stations reported with an average of over 100 messages apiece. Four stations made the BPL in this section. W3RA is keeping a sked daily with ne3WG. W3AWO says his new shielded receiver is the berries. W3CDS shows improvement. W3ADE QRMD by power leaks. W3AKB takes her old stand in the BPL. W3AVK has another new crystal. W3QP's new wave is getting out better. W3WJ wants more radio shows to raise traffic totals. The 20th Century Limited Express Route of W3ZF is still going well. W3DHT is still having trouble with BCLs.

Traffic: W3AVK 267, W3AKB 266, W3MQ 241, W3WJ 178, W3QP 178, W3ADE 170, W3ZF 165, W3DHT 63, W3AWO 40, W3CWO 35, W3ANS 24, W3CDS 22, W3RA 10, W3BFL 9, W3AFJ 6, W3AHZ 3.

## CENTRAL DIVISION

**K**ENTUCKY—SCM, J. B. Wathen, III, W9BAZ—W9ARU had to shin up 65 footer to replace a rope. He said he wasn't scared—much. W9AUH gets R6 in EG but can't QSO. W9AZY also lost antenna. W9BAN will soon be on again with a new house. Bet it's asbestos. W9BEH is a big game hunter—shoots rats from shack door. W9BGA snagged his 5th continent and wants WAC tag. Our travelling man, W9BWJ, is drilling holes in Ohio. W9CEE wrote his report from classroom. Navy Dept. sent W9CRD a nice letter for his hurricane relief work. W9CRJ has a new antenna. W9JL sports 4 852's and uses 'em all at once. Whew! Working EE, EF, and EK in row is duck soup for W9ENR. Both ops of W9MN are busy with WHAS. W9DWQ and W9FQN have returned to the fold. Welcome, Oms.

Traffic: W9CRD 41, W9BAZ 34, W9CRJ 28, W9OX 27, W9AUH 18, W9JL 18, W9AZY 10, W9BGA 10, W9ARU 6, W9BEH 4, W9DWQ 4, W9MN 3, W9ENR 2.

**ILLINOIS**—SCM, F. J. Hinds, W9APY—W9AVV is taking over the operating of W9CN. W9CZT played "Blowie" with all his condensers. W9CNY is on 150 meter lone. W9ECR and W9GCJ will try 23 mc. W9BNI dropped into Chicago for a visit. W9AFA blew the 250. Ex9CSW is on again with 10 watts. W9ELO has a schedule with the Byrd expedition. W9BTX plays chess over the air every Sat. night with W9ERU. The OW at W9AAE has just allowed him to get back on the air. Hl. W9EAJ has a new Zeppelin and mercury arc. W9CNP has an 80 meter voltage fed Hertz. W9APY is erecting new mast and antenna. W9BZO is now remote controlled. W9ERU is Sec. and Treas. of the Rockford chess and checker club and is QRV for games over the air. W9DCK is now crystal. W9ML states the Bell Telephone network of hams is in no way commercial. Only Bell employees are eligible. W9DYL is experimenting trying to get the Xtal to work.

W9DGZ runs 28 mc. tests. W9CIA worked his 60th country by a QSO with AS-RA11. The Waukegan, Ill. gang are starting a radio club. FB, OMs The Chicago Radio Traffic Assn. held its annual banquet which was a great success.

Traffic: W9BZO 33, W9EJO 77, W9CIA 76, W9MI 66, W9DCK 56, W9ACU 55, W9ERU 54, W9DYL 50, W9FCW 47, W9FO 37, W9ASE 36, W9DXG 33, W9AD 28, W9ECR, 28, W9EFD 28, W9DGK 25, W9ALK 24, W9DOX 23, W9FHY 23, W9BL 21, W9FDQ 19, W9APY 18, W9DGZ 18, W9CZL 17, W9CZF 16, W9CUH 13, W9AFB 10, W9CNP 10, W9CUO 9, W9BSH 7, W9BTX 7, W9BVP 7, W9BPX 5, W9FDJ 7, W9EQZ 5, W9BRX 4, W9DDE 4, W9BNI 3, W9AHJ 1, W9EAJ 60.

MICHIGAN—SCM, Dallas Wise, W8CEP—W8CHT has a new monitor box. W9EAY has a 1929 receiver. W9CE reports. W8AU attended the Western Michigan Hamfest at Holland with W8DWM and W8AHM. W8CKZ has been QRW. W8AMS is building a new outfit. W8BJQ has been keeping a bunch of schedules. W8ZF is ready with a new chemical rectifier. W8CWN has a new 50 watt. W8DYH has moved. W8AAF works on 3790. W8BRS is still on the job. W8CU handled one USDA message. W8BGY has gone down to 14,990 kcs. W8ACB is helping get the 1874 kc. transmitter at Cass High in commission for the coming beginners work. They have a fine class attending night school and we can expect a new bunch of operators before long. W9BTQ is going to install an 952 watt mercury arc plate supply. W8BLZ reports the Grand Rapids Club going fine now. W8DSF has a B battery operated set. W8DED is very QRW getting out the traffic paper and keeping a bunch of skeds. The Western Mich. Radio Assn. held their meeting at W8DED's October 7th. The following were present: W8AAF, W8AJL, W8AHM, W8AUB, W8CHT, W8COW, W8CPL, W8DEM, W8DUA, W8DVQ, W8DWM. The 107th Observation Squadron 32nd Div. Mich. Nat'l Guard have installed a 100 watt self-rectified transmitter at the hangar on Plymouth Road near Detroit and will be ready to work the gang on both 7500 and 3900 kc. bands using the call W8OO. Immel of W8AM is the op in charge.

Traffic: W8DVQ 10, W8CAT 18, W8CHT 3, W9EAY 4, W9CE 11, W8AUB 17, W8CKZ 4, W9CSI 22, W8BJQ 84, W8CWM 30, W8AAF 3, W8BRS 16, W8CU 11, W8BGY 75, W8ACB 8, W8BLZ 4, W9BTQ 8, W8BLZ 4, W8DOW 4, W8DSF 15, W8DED 207, W8CEP 9.

INDIANA—SCM, D. J. Angus, W9CYQ—W9AIN again leads the state with 440 messages. He is building a new crystal controlled set. W9DUZ changed QRA from Mishawaka to Nappanee and will soon be on 3750. W9FQ is putting in a new screen grid receiver. W9CFX is a new station at North Liberty. W9ASX is putting in a new antenna. W9CMQ has a new crystal controlled transmitter going on 3500. W9CMQ is a new RM. W9EKK is building a new crystal controlled transmitter. W9EPH, W9BZZ, W9FXM, W9FKE, W9EWE and W9EYY are all rebuilding according to 1929 specifications. W9AMZ is installing a transmitter at his place of business. W9MQ went back to TPTG. W9AFI will soon have a 1929 set going. W9BIA tried to sell out for the 6th time but failed so is back on. W9EVB has a battery operated transmitter. W9GBF at Purdue, formally 9CRV, is operating from his room. W9FVG is at Purdue. W9EGE and W9DZX are in college at Angola. Now W9GCO on 7500. W9RS has moved to Dayton, Ohio. W9ENX is putting in a crystal set. W9DBA again on at Washington, Ind. W9CNC is putting in a new mast. W9AEB is putting in a 250 watt. W9EJU is going again on 7000. W9DUK is on 3750 now. W9CLL was visited by W8BBH. W9FCG has his new MG going. W9EF worked OA 118 times last month.

Traffic: W9AIN 440, W9EF 92, W9GCO 34, W9ASX 34, W9FCG 36, W9CLL 12, W9BKJ 14, W9AEB 1, W9DBA 10, W9EGE 6, W9EKK 5, W9EPH 3, W9AIP 21, W9GBF 21, W9DSC 30, W9CLO 11, W9EVB 2, W9EKW 27, W9CMQ 11, W9BZZ 3, W9EPH 2, W9FXO 1, W9FXM 1, W9FQ 38, W9FCX 4, W9ASX 34, W9DUZ 1, W9CYQ 15.

WISCONSIN—SCM, C. N. CRAPO, W9VD—W9BWZ is our leader this month. W9EMD has been off the air for a time due to illness. W9DLZ tried to improve his transmitter but had tough luck. W9BPW is keeping three schedules. W9DEK is trying to QSO all the boys he met at the Convention. W9DTK is keeping schedules with W8DED and W9DGW. W9FSO has schedules with W9ASX and W9DKA. W9SO operates on 14 mc., 7000, 3500 and

1750 kc. W9GAO is reporting consistently. W9EYU has rebuilt the old haywire outfit. W9CVI continues his totals. W9EUIH gets out fine with 180 volts on 3 201A tubes. W9FAW is on 80 every morning. W9EWN is handling his share of traffic. W9BWO tried 160 for a short time. W9DZZ says his schedules went hay wire for two weeks on account of skip distance. W9FSV reports. W9EBT and W9ASL are on yet. W9DNB is rebuilding for 1929. W9EEF is on 7000 kc. now and then. W9BIB is handling some traffic when he isn't grinding crystals. W9VD is again rebuilding.

Traffic: W9BWZ 132, W9EMD 110, W9DLD 101, W9BPW 100, W9DEK 88, W9DEK 76, W9FSU 64, W9SO 52, W9GAO 43, W9EYU \*45, W9CVI 39, W9EYH 34, W9FAW 21, W9EWN 19, W9BWO 19, W9DZZ 17, W9FSV 11, W9EBT 7, W9ASL 1, W9EEF 2, W9DNB 1, W9BIB 1, W9VD 11.

OHIO—SCM, H. C. Storek, W8BYN—The old regular, faithful gang are plugging away. W8DBM leads again. W8CMB was second. W8CNO strove mightily but fell a little short of BFL. W8CXD has been working the Byrd Expedition. W8CFL is still having a lot of tough luck. W8BRR is still blowing filter condensers. W8AQU has a 1929 transmitter. W8CRI will have his OKS soon. W8CSS has several good schedules. W8BAU hopes to have a new crystal soon. W8CXW has been put on the honor roll by the Sec. of Commerce for his fine work in the Florida disaster. FB, OM, W8DBS blew his 50 and is getting an 852. W8DDK is still experimenting. W8CAU and W8EQ are on again. W8DDF sends his total. W8CNU is going to find out how good these 222 rigs are. W8CFT had over 700 QSOs this month. W8DVL reports for the first time. W8DJV is QRW school. W8APB broke his mercury arc tube. W8BAC is rebuilding entirely. W8ARW has a good neon tube wavemeter built for 1929. W8DIA is on occasionally. W8DSY is QRW work. W8BSR is coming along nicely. W8EJ reports a party at W8UP's new home. W8AYO was on. W8ADS is runner-up for ORS. W8AOE's transformer broke down. Tough luck, OM. W8DMX will have a couple of 50 watters going soon. W8GZ is on now and then. W8DTC repaired his MG; W8ADH now is W8ALC. W8DJG is going to be on regularly soon. W8DHS has almost everything necessary for rebuilding. W8DPF has trouble with his power supply. W8BKM needs a new stick up for his aerial. W8BAH has moved to Springfield, Mass. W8BYB is well started. W8RN will be with us again about Dec. 5th. W8PL is not on the air yet. The SCM is rebuilding a little for 1929.

Traffic: W8DBM 343, W8CMB 224, W8CNO 165, W8CXD 71, W8CFL 67, W8BRR 64, W8AQU 46, W8CRI 44, W8CSS 40, W8BAU 37, W8CXW 34, W8DBS 31, W8DDK 31, W8CAU 29, W8EQ 25, W8DDF 26, W8CNU 24, W8CFT 21, W8DVL 20, W8DJV 20, W8BYN 20, W8APB 17, W8BAC 16, W8CPQ 14, W8ARW 11, W8DIA 8, W8DSY 8, W8GL 6, W8BSR 6, W8EJ 5, W8AYO 5, W8ADS 4, W8AOE 4, W8DMX 4, W8GZ 3, W8OQ 3, W8DTC 2.

#### DAKOTA DIVISION

SOUTHERN MINNESOTA—SCM, D. F. Cottam, W9BYA—W9COS has been busy testing. W9DOP is rebuilding. W9EFK works WFBT. He is building a 222 receiver. W9DMA says traffic is picking up for a change. W9BFO had his station out to the fair and handled a little traffic. W9EYL has overcome key clicks. W9DBC is building a new power supply system. W9AIR says our favorite word "junk" does not apply to the 1929 outfits and that it is a real pleasure to use one. W9ERT is on the job, on 14 mc. W9BEZ has been hunting in North Dakota. He sent out CQs with a duck caller and got the limit. Now he's strong for ducks. W9DGE has five more trips on the barge line before tying up for the winter. W9BKX is ready for traffic.

Traffic: W9COS 41, W9DOP 27, W9EFK 12, W9DMA 11, W9BFO 10, W9EYL 9, W9DBC 6, W9AIR 5, W9ERT 4, W9BHZ 2, W9DGE 1.

SOUTH DAKOTA—SCM, D. M. Pasek, W9DGR—Johnny is still at the top in traffic, even tho he was off 80 for quite a while when he lost his antenna. Common, gang, let's see if the rest of us can't raise our totals some. W9DNS reports several skeds and that ex9DES is now W6CBS and that ex9BQV is now W7ANV. W9DRB and W9FCX are rebuilding. W9DLY is traveling around the state working for the telephone company. W9DB manages to operate a little in spite of the BCLs. W9EUIJ worked both coasts and the gulf in one hour with an A tube and B

batts. W9DIY and W9AGL are busy with their BC stations.

Traffic: W9DWN 816, W9DGR 53, W9DNS 45, W9DB 11.

**NORTH DAKOTA**—SCM, Bert W. Warner, W9DYV—The fall weather is putting the run on the QRN. W9DM is doing some rebuilding and is very QRW with school work. W9CDO is going to make the wind-mill run his battery charger so he can run his dynamotor for plate supply. W9CUT is attending school but finds time to handle some traffic, keep the good work up, OM. W9BVF, the new RM, comes across with a nice bunch of traffic and says he is building a 1929 transmitter. Best of luck, OB. W9DYA keeps plugging away.

Traffic: W9BVF 22, W9CUT 10, W9DYV 4.

**NORTHERN MINNESOTA**—SCM, Carl L. Jabs, W9BVH—This report comes again from W9EGU—the old SCM. W9EGN comes into the picture with a nice even hundred in traffic. W9EGU has his crystal set finely tuned now and is working regularly, keeping schedules and working DS besides. W9FFU is working on his 1929 set. W9DPB reports bad weather for radio. W9EHO was only able to keep his one schedule this month. W9CTW says he can't get a DX receiver going. W9ABV is leaving for school. W9ERB works mostly on 3500 kc. W9CF reports traffic. W9CIY is all set for 1929. W9EHI is getting some meters and reports a new ham in Duluth, viz: W9FZM, working everything with 300 volts on a 201A tube. W9DOQ is ready for 1929, since W9CKI and W9EHI hooked on his rectifier. W9BCT has moved to Ft. Snelling. W9AKM has been on the air a lot. W9EGF sent in his report from Galesburg, Ill. W9BXM lost his plate transformer. W9BVH will be on with his new 1929 transmitter as soon as he installs an antenna.

Traffic: W9EGN 100, W9EGU 42, W9FFU 32, W9DPB 30, W9EHO 22, W9CTW 16, W9ABV 14, W9ERB 13, W9CF 9, W9CIY 8, W9EHI 5, W9DOQ 3, W9BCT 2, W9AKM 1.

#### DELTA DIVISION

**ARKANSAS**—SCM, H. E. Velte, W5ABI—Fellows, we had the honor of handling the most traffic in the Delta Division last month. Let's see if we can't keep up the good work and show them what Arkansas can do. W5CK has requested that his ORS be cancelled for since the death of his father, he is very busy with the banking business. W5AQX is a new ORS. W5AIP is going to be on with a 250 wattor soon. W5QV will be on with a 180 meter fone and a 40 meter c.w. before long. W5ARI handled some traffic. W5HN is rebuilding for 1929. W5ANB is operator at KLRA. W5PX is operator at KGH. W5BCZ is busy with BCL sets. W5AMX is a motion picture operator. W5JG has finished rebuilding his transmitter. W5ZAA is getting out consistently with a 210 tube. W5AUI has turned into a battery expert. W5EP is on with a fifty wattor. W5SS has a new 55 foot pipe mast. W5AAJ is back with us. W5DD is also back. He has a new 3500 kc. transmitter enclosed in plate glass. W5ARA reports that he is getting out well.

Traffic: W5AQX 5, W5IQ 3, W5ABI 21, W5EP 7, W5SS 1, W5AAJ 20, W5ARA 12.

**TENNESSEE**—SCM, Polk Purdue, W4FI—This is the new SCM's first report and finds this Section rather inactive. Get your reports in, fellows, and let's put Tennessee up where it belongs. W4SP writes a nice letter reporting for the Knoxville gang. W4FX has a new 852 going. W4ABZ has rebuilt, and will be our new Route Manager if he wants the job. W4DG is rebuilding. W4AHD is on quite often. W4GL paid the SCM and W4FU and W4HE a visit a short time ago. W4ARR is active and reports working NJ, NL and NP. W4BU is on frequently. W4NL is about the only active station in Nashville. The SCM will be very glad to receive reports from all who take an interest in amateur radio in this section. We need more ORS: here is your chance to get into the work, OMs.

**MISSISSIPPI**—SCM, J. W. Gullett, W5AKP—W5AJJ has moved to New Orleans. We are sorry to lose you, OM. W5FQ reports schedules with W6ARV, W6DUO and W4KY. W4LU paid W5FQ a visit. W5ANP has business QRW. W6LY is now on 175 meters using fone and he has lots of fun up there, so he says. W5AED is thinking of a crystal control transmitter. W5AKP is having good luck lately.

W5BBX was hurt in a foot ball game. We hope that he will recover at an early date. I am again calling the attention of the Mississippi gang to the fact that they must report every month if they want to keep in good standing as an ORS.

Traffic: W5AKP 53, W5FQ 17.

#### HUDSON DIVISION

**EASTERN NEW YORK**—SCM, F. M. Holbrook, W2CNS—W2BFF and W2BGB are our newest ORS. W2ABY handled traffic from New Haven Radio Show. W2AXX is getting his 1929 transmitter in shape and has helped W2ACK on the air. W2BKN is keeping good schedules with KFR6. W2AYK has a new car. W2SJ operates Morse lines and control board at WGY when not agitating bug at W2SJ. W2BGB has filed application for N. C. S. for Albany County Army Amateur. W2ACD is on every day after 6 p.m. W2BPV, ex-8BQK, is trying to put Schenectady on the map. W2ACG attended Cambridge Radio Club and handled message for WIKY on her set. W2BOW is still playing with television. W2ANS is elated with a new shield-grid receiver. W2ACY reports many new hams starting. W2BHV has an 852. W2AAN has a new QRA. W2JE overhauling the set for 1929. W2APQ is waiting for new 50. W2BLE and W2BNF anxious to form Westchester Radio Club.

Traffic: W2BFF 97, W2ABY 64, W2AXX 28, W2BKN 16, W2AYK 13, W2SJ 12, W2ANV 11, W2BGB 8, W2ACD 7, W2BPV 6, W2ACG 4, W2CNS 1.

**NEW YORK CITY & LONG ISLAND**—SCM, M. B. Kahn, W2KR—The usual reliable stations are continuing their fine work and New York is still carrying most of the traffic from Byrd's expedition through W2ALU, W2KR, W2BRB and W2BFY who maintain daily schedules with the fleet of ships bound for the Bay of Whales.

Manhattan: W2ALU has a new transmitter on the air. W2KR is going to rebuild. W2ANX is back on the air with a 1929 set. W2BGO tries to arrange skeds with most every station he works. W2AFO is rebuilding for 1929. W2BNL reports. W2BCB has a fine transmitter going.

Bronx: W2APV has been delivering plenty of messages to people in N.Y.C. due to his nightly sked with NJ2PA. W2BPQ is a very active station and is due for an ORS. W2BBX was forced to resign his Route Manager's job due to work and college (Sorry to lose you, OM—SCM). W2AET is off on account of rebuilding. W2CYX reports.

Brooklyn: W2BRB is handling plenty of traffic from WFBT on 20 meters. W2PEF is very busy with his Army-Amateur work. W2CRB moved and is on 14,000 kc. with low power.

Long Island: W2BFY, who has been keeping L. I. on the map, is leaving us and moving to New London, Conn., where he will sign W1ANG in the future. W2AVP still keeps up his traffic. W2ASS reports that the Nassau Radio Assn. has a good start, a good transmitter and twelve good (?) operators so far. W2AVB expects to be on very soon with a new 1929 rig. W2BO will soon have his new transmitter on the air. W2ALS will soon be on with a new outfit.

Traffic: Manhattan: W2ALU 240, W2KR 144, W2ANX 32, W2BGO 24, W2AFO 21, W2BNL 6, W2BCB 6. Bronx: W2APV 173, W2BPQ 52, W2CYX 32, W2BBX 10, W2AET 3. Brooklyn: W2BRB 78, W2PEF 26, W2CRB 6. Long Island: W2BFY 206, W2ASS 58, W2AVP 79, W2AVB 10.

**NORTHERN NEW JERSEY**—SCM, A. G. Wester, W2WR—W2CTQ had the misfortune to have his new mast come down. W2JC is still operating on 7000. W2CJD had to dismantle the works due to paints working in his shack. W2JG is all set up again and is going out to find traffic. W2BDF has a small transmitter on 7000 while the large transmitter is under construction. W2ANG is on every night from 8 to 11 p.m. W2CJX has resurrected some of his 500 cycle equipment from spark days. W2BY received a report from Poland. W2IS has installed a MOPA which works fine. W2AOS is acting NCS for the Army in N. J. W2BJI is now permanently located at the YMCA building in Hackensack. W2BGG is on 3500 and handles a good amount of traffic. W2BIH and W2BFW are on the air quite regularly. W2GE is still at Netcong with the A. T. & T. Co.

Traffic: W2JC 8, W2CJD 4, W2BDF 7, W2ANG 12, W2CJX 6, W2BY 3, W2IS 4, W2BGG 26, W2AOS 29.

## MIDWEST DIVISION

**IOWA**—SCM, H. W. Kerr, W9DZW—Iowa has four stations in the BPL this month. Fine work fellows—now let's increase that number next time and see to it that Iowa is at the top of the list. W9DEA again heads the list but leading close behind are W9EDW and W9DGW. W9EDW has a daily sked with the Byrd Expedition and declares he will keep it until the South Pole is polarized. W9DGW has a new Zep working on 7000 kc. and 3500 kc. with five skeds, QRV all directions. W9BCA tops the deliveries with 54 for the BPL list. W9EEN is added to the OBS list with skeds at 7:15 pm daily on 3550 kc. or 7700 kc. except Sunday. Herm tied with W9CZC on this month's totals. W9CKQ is still QSO daily with oa-5HG. W9EJQ is lining up on the XC relay chain. W9CUX is commercial op on the S. S. Puritan but will be on at home for winter tie-up. W9FJA is originating messages around the college. Seems as though we should increase the number of messages originated in Iowa above 119. Let's go.

Traffic: W9DEA 271, W9EDW 252, W9DGW 240, W9BCA 188, W9CZC 59, W9EEN 59, W9DZW 41, W9CKQ 31, W9FJA 21, W9CVU 19, W9BP 12, W9EJW 8, W9EJQ 6, W9DPL 5, W9ASM 5.

**KANSAS**—SCM, J. H. Amis, W9CET—W9FLG leads the Section. W9CFN has QRM from school. W9DIH has two xtals. W9BHR has a one tube MO-PA. W9CET sold his 222 receiver to Himoe of WNP fame. W9DFY lost his power transformer. W9LN has a nice bunch of skeds going. W9HL is getting a bunch of skeds lined up and can QSY 3500, 7000 and 14,000 kc. W9BII is sending code practice on 1880 kc. every night from 7 to 8. W9CKU is going strong on 3500 kc. A new RM will be appointed soon. W9BPL receives a letter from NR2FG and says he will be on again Nov. 15th. W9DNG has a real YL now and says she will soon be his OW. W9BUY is back from Cuba.

Traffic: W9BPL 14, W9LN 56, W9CKV 36, W9BII 13, W9HL 3, W9DFY 12, W9CET 82, W9DIH 14, W9CFN 48, W9FLG 114, W9BHR 18.

**NEBRASKA**—SCM, C. B. Diehl, W9BYG—W9ANZ now has a crystal on 7050 kc. W9QY and W9EEW are very busy these days. W9DFR says his new QRA is FB. W9DUR and W9FAM are rebuilding. W9DI has overhauled his outfit. W9DNC sends us a wonderful report. W9BOQ has a new dynamotor. W9CHB is in school. W9BBS is rebuilding. W9CDB has his almost finished now. Mrs. W9BYG has been under the weather for a couple of weeks so OM W9BYG has not had all of his time to put in on radio.

Traffic: W9ANZ 6, W9DVR 7, W9FAM 39, W9DI 9, W9DNC 10, W9CHB 9.

**MISSOURI**—SCM, L. B. Laizure, W9RR—Activity in St. Louis came to a climax with the radio show recently. Over 500 messages were dispatched from stations of club members. W9ZK has two new 1929 models on the air. Considerable traffic was handled through W9ZK this month. W9BEU handled some unusual DX, keeping a nightly sked with OO-BAM. W9DZN is back with a 250. W9BMU is also QRV for traffic. W9DUD had school QRM. W9DLB is keeping a sked with W9DAE. W9DSU got his stuff hooked up. W9FFW sends his first report. W9DOE got his 852 hooked up in a TPTG layout. W9DAE, RM, sends in a good report of skeds. W9DAE is having considerable rectifier trouble. W9DHN reports for the first time. The 20th Century relay route has been extended into Missouri via W9AIN and W9DAE. W9BBO lost his mast and antenna in a storm. W9BSV and W9BUL are rebuilding. W9BZM was on a few times when home from school. W9ASV is hooking S. W. Mo. up with his sked with W9DKG. W9FEQ is on regularly. W9EUB is on. W9DKG says skeds are doing wonders for traffic. W9CJB handled some official traffic to Brazil. W9ERM applied for USNR and kept a few skeds when possible. W9ATW is in the U. of Mich. this year. W9DVF operated from W9CNS. W9BJA handles traffic. W9FVM reports for the first time with good traffic. W9EUA sends his last report as he is QRD Melbourne, Fla. W9CDF is back home. W9ECS handled some Byrd Expedition traffic. W9FBF kept skeds on 1520 kc. with W9IK and W9PSI. W9FNJ keeps a sked with W9FBO. W9DVK comes back with traffic. W9AYK hit the BPL this month. The SCM depends on W9AYK hit the BPL this month. The SCM depends on W9AYK for most of his traffic due to inability to match operating hours with anyone else. W9GBC reported by radio as did W9AYK. W9BQS rebuilt

the works. W9EPX sends in a very complete report by card and letter. W9DMT kept an irregular sked with W7LE. Kansas City stations are trying to make up for small numbers by more intensive activity per station. W9EQC hit the BPL and kept several skeds, the most DX sked with W6BTX. W9FIO keeps skeds east and south and is getting out well, traffic for Joplin and vicinity will move readily via W9FIO and W9FEQ. W9RR is on for traffic on 3500 kc. band at 12:30 noon and after 1 am CST daily except Sunday. W9DQN will resume skeds soon.

Traffic: W9BEQ 421, W9ZK 86, W9BEU 42, W9DZN 30, W9BMU 27, W9DUD 13, W9DLB 8, W9DSU 7, W9EPX 16, W9DMT 10, W9ECS 23, W9GBC 2, W9AYK 232, W9DVK 3, W9FNJ 39, W9CDF 13, W9EUA 25, W9FVM 23, W9BJA 61, W9DVF 2, W9ERM 10, W9CJB 22, W9DKG 17, W9EUB 4, W9ASV 46, W9DAE 35, W9DHN 7, W9FIO 10, W9DQN 14, W9EQC 112, W9EMH 13, W9RR 79.

## NEW ENGLAND DIVISION

**NEW HAMPSHIRE**—SCM, V. W. Hodge, W1ATJ—W1P again leads us. W1ARW is just getting started in Manchester. W1AEU sends in a fine total. W1BET has a MO-PA going on 7000 kc. He reports W1BK, W1IH, W1BLA and W1AIA active in Durham. W1AUY says lots of QSO's but not much traffic. W1AFD is back on 3500 and anxious for traffic. W1AEF's 1929 transmitter is perking FB. W1JN reports. W1ANS sends in a good report. W1BST in Berlin is getting out fine with his new transmitter. The SCM has received his commission as Ensign in the Naval Reserve and would like to hear from anyone interested in enlisting in the USNR.

Traffic: W1IP 109, W1ATJ 98, W1AEU 53, W1BET 33, W1AFD 26, W1BST 17, W1ANS 16, W1AEF 9, W1AUY 1.

**MAINE**—SCM, Fred Best, W1BIG—The Route Managers, as lined up for the coming traffic year, will be: W1CDX, southern and western Maine; W1AUR, Central Maine; W1AQL eastern Maine, and W1ANH, northern and northeastern Maine. Maine is particularly lucky to have so many qualified traffic men, and it is our hope that Maine regains her old prestige as a real traffic section. W1AQD and W1AQL are Official Observers. OM and OW W1AJC send in a fine total. Mrs. W1AJC reports a new ham in Portland, W1CTR. W1AUS handled a good string. He is lining up the hams of Lewiston and Auburn and hopes to form a club soon. W1ART reports hearing K-FR6. W1KQ with a beautiful note on 3500 kc. turned in a fine total. W1AHY gives us a fine initial total. W1AQD, our 28 mc. pioneer, did some real work this month. W1BIG rebuilt his outfit and now has a 1929 model. W1ASJ is located on 3500, 7000, and 14,000 kc. W1COV has hopes of being an ORS soon. W1BFZ will be back on the 3500 kc. band.

Traffic: W1AUF 323, W1AUR 198, W1CDX 54, W1BIG 48, W1ANH 41, W1AJC (OW) 37, W1ASJ 54, W1ART 27, W1AJC (OM) 19, W1AQL 17, W1COV 14, W1KQ 12, W1AHY 11, W1AQD 8.

**WESTERN MASSACHUSETTS**—SCM, Dr. J. A. Tessmer, W1UM—W1BWY says the Springfield Radio Association is active. QRH is 7100 kc. W1EO is on 3500 and 7000. W1AKZ's new QRA is 67 Halford St. W1AJK, the very active secretary of the W. R. Assn., pounds brass weekly (not weakly) with the Naval Reserve. W1BKM is reporting himself on 3710 kc. W1AMZ is still plugging away at school. W1RSJ can almost always be found at W1BWY. W1ADO has joined the Naval Reserve. Much credit is due him and W1ASU and the score of operators handling the 240 messages of the Worcester Radio Show of which 177 were sent from the point of origin through W1BCO. W1ANI keeps schedule with W2SC Mondays, Wednesdays and Fridays, 9:30 pm. Please look for him on 3520 kc. for official broadcasts. The Worcester Radio Assn. thanks W1BLV, W1BWY and W1AAW for handling such a great number of messages for them. All hams are cordially invited to attend the Sun, morning talks at the headquarters of the Worcester Radio Assn. 274 Main St., Room 301, at 10:45 am.

Traffic: W1BCO 190, W1RWY 30, W1ANI 56, W1BKM 20, W1EO 12, W1AKZ 10, W1UM 5, W1ADO 2, W1FG 2.

**VERMONT**—SCM, C. A. Paulette, W1IT—W1CGX takes the high mark this month. W1YD is getting on the active list now. W1BJP is still QRW with his work. W1AOC has to work until 9 pm yet he turns



in a report and is keeping a sked besides. W1AJG has been very QRW. W1IT has dusted the old set off. W1BCK has been traveling. Any station not an ORS is invited to report. Due attention will be given your reports, OEs.

Traffic: W1CGX 68, W1A00 59, W1BJP 12, W1IT 8, W1YD 6, W1AJG 4.

CONNECTICUT—SCM, C. A. Weidenhammer, W1ZL—Our honor roll this month includes WIAMG, W1AFB and W1MK. We neglected to mention that W1ASD was honored in the same fashion last month. W1TD and W1BNS were other stations with totals of over a hundred. W1VE had a new antenna in operation only a few days when an irate BCL cut it down. W1PE is using a 210 on 8500 kc. and expects his brother, W1AZE, to open up soon on 7000 kc. with a 50 watt. W1VB is still busy on 8500 kc. W1HJ is using a 210 in the TP-TG circuit and is attempting to work his brother in the Philippines. W1CTI and W1BWM paid the Danbury gang a visit recently. W1ATG is expecting to return to the air with a "bang" shortly. W1AMC is studying hard to get good grades. W1AMG is going "great guns" on 7000 kc. W1BMG is back with an 852 on 7000 kc. W1BJK is busier than ever with his telephone work. W1BGC has been exploring the mysteries of the Zeppelin antenna. W1AFB not only made the BPL this month but also worked a station on a rubber plantation down on the Amazon. He put fifty messages across the Atlantic. FB. W1TD reports that the T. C. R. club had an exhibit at the New Haven Arena Radio Show through which 270 messages were handled. W1BHM is active now on both 3500 and 7000. W1BNS is very busy with football. He is on 3500 kc. and ready for your traffic, though. W1BL-W1BQH is the happy owner of a commercial ticket. W1OS was visited by five out-of-town hams called during the month. The YL is getting splendid reports on her B battery set. W1M has been appointed one of the Jenkins Honor Roll Radiovision Reception stations. Nice work, Cliff! W1MK was heard and called by G5ML at 6 o'clock a few evenings ago. Who said the 3500 kc. band could not be used for DX? A hay-wire set with a 210 was hooked up and W1ZL worked W6BAX on 28 mc. The SCM is having difficulty in finding enough room for a decent 3500 kc. antenna. W1RP has erected a new Zeppelin antenna. W1BLF is very busy with auto repairing work.

Traffic: W1VE 38, W1PE 32, W1VB 29, W1HJ 21, W1CTI 19, W1ATG 6, W1AMC 7, WIAMG 306, W1BMG 5, W1BJK 7, W1BGC 3, W1AFB 254, W1TD 146, W1BHM 10, W1BNS 103, W1M 9, W1RP 30, W1MK 464.

EASTERN MASSACHUSETTS—SCM, E. L. Battey, W1UE—W1AKS again leads in traffic with 227 msgs. FB. W1WV makes the BPL with deliveries. W1LM reports early. W1AAW is active. W1CQ keeps 35 schedules per week. W1BTT is doing good work. It is with much regret that the SCM announces the passing away of W1IU of Concord who although 70 years of age, was one of our most active hams. W1RF, W1BDV, W1GP and W1UE are studying hard. W1KH paid W1MK a visit and says it's a wonderful station. W1KY is kept busy with her RM work and schedules which she keeps. W1AXA and W1PB are back on the air. W1BVL worked W6UF on 28 mc. W1AZE is on. W1APK heard signals from the *Graf Zeppelin*. W1NK anticipates sending play-by-play report of Revere-Nashua football game to W1TA. That's real amateur work, OM. W1ACA is on 150 meters. W1CMZ has worked all continents but Asia. W1RY copied the Navy Day broadcast. W1FL was in the hospital. W1ACH is keeping schedule with W1MK twice a week. W1ASI is QRW BCK work. W1BIX is active. W1RL has new shack built in his cellar. W1SB has new antenna system. Doc of W1IA has a beautiful signal on 14,000 kc. All hams who are League members are invited to send their reports in each month to the SCM and he will put as much as he can in the reports regarding everyone.

Traffic: W1AKS 227, W1WV 143, W1CQ 93, W1ACH 81, W1KY 67, W1ACA 82, W1CMZ 40, W1RY 36, W1LM 32, W1KH 31, W1AAW 31, W1BVL 15, W1PB 13, W1BIX 12, W1FL 10, W1NK 8, W1ASI 6, W1AZE 6, W1UE 5, W1APK 5, W1BTT 2.

RHODE ISLAND—SCM, C. N. Kraus, W1BCR—W1BIL is back on the air again permanently. W1BLS says conditions seem to be getting better but not much message traffic. W1CKB has been off all month due to rebuilding of his transmitter for 1929. W1MO

says traffic is scarce and DX is very poor. W1BDQ's 2000 volt power transformer blew out twice. W1BLV sends in a good report.

Traffic: W1BLS 10, W1MO 8, W1BLV 51.

#### NORTHWESTERN DIVISION

IDAHO—SCM, James L. Young, W7ACN-W7YA is installing a crystal. W7AB is the USDA station for Boise and is acting RM. W7IY-QA is still on the job and hands in a nice traffic total. W7EJ is on regularly on 7000 kc. W7ALC is working DX on a 201A with 175 volts on the plate, clicking a couple of first district stations. Both W7ALC and W7EJ are after ORS appointments. W7AMG is one of the ops at W7YA. W7UJ and W7AOC (ex-9BKH) are installing the new broadcast station, KIDO, formerly KFAU. W7HK is going with W7ACK, W7ACN, and W7AFK at the key and about twenty new ops in training. W7CW is home for a visit. The SCM wants to hear from every station in Idaho so that we can get better organized to put Idaho on top. Let's see a report from every Idaho ham.

Traffic: W7ABB 102, W7YA 46, W7QA-IY 35, W7ALC 26, W7EJ 16, W7ACN 4.

OREGON—SCM, R. H. Wright, W7PP—W7ABH has handled traffic to Byrd from WFAT. W7WR shows a good total this month. W7LT has been on 14 mc for the past month. W7PL has been experimenting with antenna and filter system. W7AJZ signed up for a hitch on the Coast Guard Cutter *Algonquin*. W7NP is back on his light ship job. ex-W7M has taken the S. S. *New York* to the Orient. W7AEK is very QRW with his YLs. W7RZ is delighted with his new transmitter. W7VQ is married now. W7MV is on occasionally. W7UN, the "Big Noise of Oregon" is on consistently, handling the bulk of Portland's traffic.

Traffic: W7WR 47, W7UN 45, W7ABH 23, W7LT 17, W7PL 19, W7AKK 11, W7SI 11.

WASHINGTON—SCM, Otto Johnson, W7FD—W7TX leads in traffic this month, maintaining his Alaskan schedules and clearing much VOQ traffic. The Gunstons tie for second place, Bill, W7AAE and Red, W7GP keeping Tacoma and Olympia represented on 14 mc. and 7000 kc. Casey, W7IZ maintains his schedule with nn-7NIC. Tommy Baird reports activity in Spokane. He has a new MO set going now. W7ADB is a newcomer in Tokio. W7AKU is working on television transmitters. W7LZ says monitor boxes are the clear dope to check on your sigs. And now for some real news! Washington now has a real YL op in the person of W7AOW. Welcome, Dolores, and may you work all the boys you met at the convention. "OU" at W1MK please note—We hope to have a photo of Dolores in our next issue of QST. We also have two OW ops coming at W7LZ and W7FD. HI.

Traffic: W7TX 74, W7GP 43, W7AAE 48, W7UI 33, W7LZ 21, W7AKU 17, W7WI 15, W7IZ 15, W7ACA 18, W7ACS 10, W7KT 10, W7ADB 6, W7FD 5, W7VL 3, W7AGO 3.

MONTANA—SCM, O. W. Viers, W7AAT-W7JC handled a number of messages this month. W7DD says the new 250 watt outfit is getting out fine. W7FL says the new UX250 chirps too much. W7ZU has his new 1929 station built. W7AAW was experimenting on 28 mc. W7EL has been busy. W7HP has a new transmitter. W7LC in Billings is on 7000 kc. with a 50. W7AFP at Red Lodge is still very busy. W7AAT-QT made the BPL this month. This station may be found on 7550 and 3780 kc. every day and night. Speedy and reliable QSR is guaranteed.

Traffic: W7AAT-QT 256, W7JC 51, W7DD 21, W7FL 7.

#### PACIFIC DIVISION

LOS ANGELES—SCM, D. C. Wallace, W6AM—Three stations make the BPL this month. W6BZR, W6ZBJ, and W6UJ with forty stations reporting to this office. W6BZR reports that power leak prohibited extensive work. W6BZR was "QSO four continents in five hours." W6ZBJ is keeping some good skeds. W6CHA put up a new Zepp using No. 6 wire. W6UJ had a big month. W6HT attended the Convention at Oakland. W6OF reports conditions on 80 meters getting better. W6DKX is building a new transmitter for 14 mc. W6APW is going to school. W6BRO enjoyed the Convention. W6ABK now has a TP-TG set. W6BJX won 2nd prize in

the receiving contest at the Convention. W6AKD has been rebuilding the transmitter, W6AWY got an 852 whine in San Francisco. W6DK has discovered that the spring coil out of old blinds make good high amperage air cooled resistors. W6AOS worked WFBT. W6AM was reported R9 on 3500 kc. in Japan. W6AGR and W6DBM send in good reports. W6ALR is going to build a new set. W6DHM is quite busy. W6ASM wants to hear more stations on 14,000 kc. W6EKC is going to be an ORS. W6EEB is taking night school course on telephony with W6DHU and W6ALG at U. C. L. A. W6COT has heavy QRM from school. W6GHT is still aboard Kemp. W6CUH's sked is still going strong. W6DHR is keeping two skeds. W6PY is on. He has W6APN oping there, too. W6ZZA reports QSO's were had with Mrs. W6AM from ARRL Convention at Oakland and from Spokane, Wash. W6AKW announces that W9FAN has moved to a ranch  $\frac{1}{2}$  mile from W6AKW. W6AHS has just quit the S. S. Astoria, KGEF and is now operating KGHV. W6DEG reports that Dan of W6ANO and his Arizona gang visited W6DEG station enroute to the Oakland Convention. W6HHR reports as usual. W6CAG has an 852 now. W6BGC has been promoted to "Chief" at KFSG. W6AHS is operating KURC, S. S. *Cathwood*. W6DSG is rebuilding. W6CBD has moved. W6EAF is OK for 1929 now. W6DLK is moving and rebuilding. W6DOW worked South Africa both ways around the same day and also five continents the same day. This sure is FB.

The next quarterly banquet of the Los Angeles Section will be held in Long Beach under the auspices of the Associated Radio Amateurs of Long Beach. W6ELZ is in charge with W6HT assisting. Director Babcock is going to be there and a large time is promised. Oct. 27th, Navy Day, a general invitation was extended to the Los Angeles Section hams to come over to the U. S. S. *Idaho* by Lloyd M. Jones, W6DOB, and among the visitors were W6QF, W6DY, W6DKQ, OM and YL, W6BZR, W6AVJ, W6ASM and W6ELZ. The Pasadena Shore Wave Club holds its meetings in the lecture room of the Pasadena Public Library. W6BJX is secretary. The Amateur Radio Research Club of Los Angeles holds regular meetings each Wed.

Traffic: W6BZR 226, W6ZBJ 214, W6CHA 120, W6UJ 177, W6HT 70, W6OF 54, W6DKX 49, W6APW 45, W6RHO 37, W6ABK 33, W6BJX 23, W6AKD 20, W6AWY 19, W6DKV 19, W6AOS 17, W6AM 15, W6AGR 14, W6DBM 13, W6ALR 12, W6DHM 12, W6ASM 9, W6EKC 9, W6EEB 8, W6COT 7, W6GHT 7, W6CUH 6, W6DHR 6, W6PY 5, W6ZZA 2, W6AKW 1, W6AHS 1, W6DEG 1.

EAST BAY—SCM, J. W. Frates, W6CZR — In spite of all his other work, W6IP managed to remain high traffic man and to make the BPL, W6BI, a good member of the Night Hawks, took second place through skeds with K6DV and K7AER. W6CTX still maintains his skeds with JXIX and other AJ stations regardless of QRN and bad weather conditions. W6SR set up at the Elks Carnival in Berkeley during the convention and pounded out quite a bit of traffic; W6CGM has been in San Jose for several weeks. W6DDQ and W6DJE handled a large number of messages from the Business Mens' Fair at Suisun through a sked with W6ALX. W6BSB has been boosting his traffic totals. W6HJ keeps his sked with K7AER. W6DWI expects a new call shortly. W6DTM is waiting for the announcement of prizes in the section contest. W6CDA blew the rectifier for the UX-852. W6AWF still pounds away with his usual steadiness. W6ALX expects to be on 3500 kc. soon. W6OJ is a movie cameraman and just passed through to make a South Sea sequel to "White Shadows in the South Seas" with Ramon Navaro and Renee Adoree. W6EBA says the high-C TPTG is the caterpillar's nightshirt and that he is moving his QRA to get away from his pet power leak. W6BUX is back to the 7.5 wattar after blowing a fifty and four UX-280s but is keeping a sked with ac-WUQ with R6 report. W6BZU reports that he hears BCL music on the harmonics of his wave and wants to know if his transmitter is broadcasting. Page Ross Hull! W6BPC says QRM from NPG arc mush is terrific. W6EDR is handling more and more traffic every day. W6CZR still trying to recover from winning the division Liar's contest at the convention but hopes the prize isn't any lie. W6IT, "Scotty," delivered three messages in person at a cost of three gallons of gas to save postage. H1. W6RMS is working the K6 section. W6RJ will be on 3500 kc. soon. W6COL has been moving his QRA. W6CLZ

is still QRW with school. W6EY and W6ALV are rebuilding.

The Oakland Radio Club is back in form after the convention and will give prizes to high traffic men in the Section. W6DCZ is the new secretary and W6BDU is the new Sgt. at Arms. Thanks are due Dr. Chas. Herrold of KFWM for the publicity he is giving amateur radio.

Traffic: W6IP 258, W6HI 99, W6CTX 57, W6ALX 54, W6SR 48, W6CGM 34, W6DDQ 29, W6HJ 25, W6BSB 23, W6DWI 21, W6DTM 14, W6CDA 14, W6AWF 10, W6EBA 10, W6BUX 8, W6BZU 7, W6BPC 7, W6EDR 7, W6CZR 6, W6EDK 6, W6IT 3, W6BMS 1.

SANTA CLARA VALLEY—SCM, F. J. Quement. W6NX—W6AMM probably delivered more messages this month than any station in the country. His daily sked with op1HR is running along very smoothly. W6BHY is installing crystal control and rebuilding along 1929 lines. W6BMW has taken over the W6NX-W1MK sked with good success. W6BNH is going over to 1929 performance. W6ALW's regular QRH is 30,000 kc. although set can be raised to 14,000 kc. with 1929 performance in a jiffy. W6BYH is also rebuilding. W6NX is now on the air with MOPA. W6UF made radio history this month when he was QSO England on 25 mc. W6CDW and W6CZL are both using MOPA. W6KG is rebuilding into crystal control. W6ARV is putting in Mercury Arc and also crystal control.

Traffic: W6AMM 586, W6BHY 34, W6BNH 10, W6BMW 16.

ARIZONA—SCM, D. B. Lamb, W6ANO—W6CDY is busy with school. W6BWS plans to rebuild with crystal. W6EKY is a new station. W6DGY will be on the air soon. W6BJF is hitting the ball in fine style. W6AZM can't get out of town. W6EAA is going to school, too. W6ANO attended the radio convention, in Oakland and met a lot of the gang. W6SW is busy.

Traffic: W6ANO 10, W6EAA 3, W6BJF 29, W6CRA 6, W6BWS 18, W6CDY 15.

PHILIPPINES—This report came by radio through W6AMM—Lt. G. A. Bicher reports that op1HR keeps schedules with acWUQ, acZAB and ac8MO in Tientsin, China; op1RC in Cavite, P. I.; and W6AMM in San Jose, Calif. Messages may be routed through op1HR for the following destinations: United States, Hawaii, Malay States, Dutch East Indies, China, and the Philippines.

Traffic: op1HR 994.

SACRAMENTO VALLEY—SCM, C. F. Mason. W6CBS—All ORS in the Sacramento Section are going to be cancelled and new ones appointed. W6CBS is going to be on with 500 cycles soon.

Traffic: W6DVD 8, W6EEO 42.

SAN DIEGO—SCM, G. A. Sears, W6BQ—W6AJM still heads the list on traffic. He is rebuilding and moving the set into a new shack. W6EC ran up a fine big total with five skeds. W6BAS is working temporary sked with portable W6WL, Fred Wisner while he is at Point Arguello doing some installation work for USN. W6WL pounds in at San Diego about R10 nightly. W6RYZ was off ten days vacationing. He keeps daily sked with K1BD. W6BQ is on 3540 kc. most of the time. W6BGL reports fine time at convention. W8CNK says school and radio don't mix. W6BAM is back on 3500 kc. again arranging skeds for winter. Ex9DES is now W6BCS at Santa Ana. Welcome. OM, W6FP has been promoted and is now Supt. of Northern Dist for the Power Co. and is moving to Oceanside. W9DGW is busy. W9BZD has weekly sked with nn-1NC. W6QY reports daylight QSO east coast on 14,000 kc. W6FFE reports some traffic. W6BAG is joining Uncle Sam's Navy. W6AKZ has new gear for 50 watts now. W6ANC reports again, ready for winter traffic. W6ADW sends in report for first time. W6SJ is back in San Diego and will be on again soon. W6AJM accompanied by W6DMS, W6BGL and W6ECH attended the convention in Oakland, and reported big time had by all. All but one station reported on time this month. FB, fellows! New members are being added to Communication Section of USNR regularly. The Radio Room at the Armory is about completed and over half of the equipment installed. NDT will be on the air on 3540 kc. in a short time. Amateurs interested should investigate at once.

Traffic: W6AJM 376, W6EC 234, W6BAS 87, W6BYZ 80, W6RQ 25, W6BGL 23, W6CNK 25, W6RAM 19, W6FP 17, W6DGW 17, W6ADW 15, W6BZD 12, W6QY 7, W6FFE 4, W6BGA 2.

HAWAII—SCM. F. L. Fullaway, K6CFQ—K6DQQ turned in a good report. Says that K6DWZ was over for the fair and that he met him and went over his outfit on the submarine. K6AVL is still active and reporting. K6DPG has a 500 cycle generator. K6DCU handled some during the week-ends. K6CLJ got across the U.S. and Australia on ten meters. K6DEY is now oping on the SS *Calawaiti*. Turned ham in port and built a ham transmitter out of coffee cans and bent nails. That is the truth. It was some hay wire looking outfit but it perked. May have a picture for you some day. K6BDL is home again and promises to go back on the air.

Traffic: K6DQQ 128, K6AVL 65, K6DPG 36, K6DCU 10, K6CLJ 7.

### ROANOKE DIVISION

**N**ORTH CAROLINA—SCM, Enno Schuelke, W4SJ—Fellows, I want to express my appreciation to all of you fellow-hams in the N. C. Section for the election as SCM. With your cooperation, we can make this section one of the leaders in Amateur Radio, and one which we can justly be proud to be residents in. W4AEW leads all stations in this section. W4AB and W4OH are back at school. W4JR is now on the engineering staff at WBT. W4TS is on with a new 210. He and W4AFW have applied for ORS appointments. W4HV was QSO *Graf Zeppelin* while over N. J. W4SJ reports QRM on 7000 kc.

Traffic: W4AEW 82, W4VH 25, W4TS 22, W4HV 5, W4JR 2.

VIRGINIA—SCM, J. F. Wohlford, W3CA—The SCM would like to hear from some ham in this section that is interested enough in the radio game to handle the Route Manager job for this state. W3KU has returned from sea duty and is again on the air. W3WM is rebuilding his station. W3II is tinkering with television. W3TN is still on WJCK. W3ANY hopes to get on during the winter months. W3NMDL is using two 210's on 8500 kc. W3IE is on with two WE-216's. W3BFE is QRM business. W3PO is back on the air. W3TJ runs WRVA but is on on Sat. and Sun. W3ALS took eight messages at one jump from un-INIC. W3HY has been issued an ORS. W3BZ threatens to try his hand on 3500 kc. shortly. W3CKL has no trouble reaching all around the lot. W3RDZ hopes to come on soon. The SCM visited in Richmond during the month and had a great time chewing the fat with the gang.

Traffic: W3ALS 81, W3CKL 97, W3HY 2.

WEST VIRGINIA—SCM, C. S. Hoffman, Jr., W8HD—W8APN handled over 100 messages this month. He reports visits from W9AZY, W8DNN, W8BSZ and W8VZ. W8CFQ has new set working on four bands above 28 mc. W8VZ still on at W8SP. W8DNL moved to Wheeling from Columbus and has schedules now with W8CER, W8BAU, W8CLQ and his brother visited W8HD. W8DNN says the visit from W9AZY made up for his misfortune of blowing a couple of tubes.

Traffic: W8APN 100, W8CLQ 64, W8DSP 36, W8DNL 22, W8AUL 2, W8DNN 2.

### ROCKY MOUNTAIN DIVISION

**C**OLORADO—SCM, C. R. Stedman, W9CAA—It is with deep regret that we announce the passing away of Dick Chase, W9FUY, one of the best known hams in the section. Dick was one of our best liked fellows and will be greatly missed. W9BQO has moved to a new QEA and is expecting to get going soon. W9CSR has put in a master oscillator outfit built along 1929 ideas. W9EUR says he has been too busy with school work to do much but handled a little traffic. W9DRV, W9FEM, W9EOO, W9EUR and W9CTP are other active Pueblo stations. W9DQV at Grand Junction is stepping into it, and has made application for an ORS appointment. W9FUY put through a good total using a W.E. tube. The Radio Inspector for the 9th district, Mr. Hayes, was through Colo. with the result that practically all hams have 1st class ham tickets or better now. W9DKM got him a first commercial and is celebrating on 3500 kc. W9CDW got a commercial second ticket. W9CDE is doing his usual good work in his limited time. W9ERN reports. W9AYP is active again on 3500 kc. W9ASB is busy. W9CAA is crowded for time with his work. W9FPZ sends in his first report. W9EAM, W9BYC, W9ESA, and W9CDQ are on deck. W9CHV has joined up with the RI's office and at present is in Detroit. In the meantime, his wife runs the set as she has a ticket.

Q S T FOR DECEMBER

too. W9CCM, the other Denver YL, is temporarily off as her big brother swiped her 50 watter.

Traffic: W9FUY 95, W9CAA 88, W9DQV 62, W9CDE 20, W9ASB 13, W9EUR 9.

UTAH-WYOMING—SCM, P. N. James, W6BAJ—The SCM would like to impress upon all ORS that their reports should be mailed on the 26th if they want to be included in QST. Reports from other stations are always welcome. Applications for OBS are needed. W6BAJ leads the traffic list this month with W6BTX-W6DPJ close behind. W6BTX teaches at Westminster College where W6DPJ is a student. They have joint station there with an indoor antenna operating on 7600 kc. W6DZX is on 7000 and 14,000 kc. keeping two schedules. W6DPO is very busy at the B. Y. U. W6DYE spent the month experimenting with his antenna and transmitter. W6RV is busy at the U. of U.

Traffic: W6BTX-W6DPJ 17 (Sept.-Oct.), W6BAJ 47, W6BTX-W6DPJ 41, W6RV 17, W6DZX 12, W6DPO 5, W6DYE 4.

### SOUTHEASTERN DIVISION

**A**LABAMA—Acting SCM, S. J. Bayne, W4AAQ—Well, fellows, with the advent of cooler weather and better conditions, the next report should certainly show decided improvement. Let's all pull together. W4AAH is doing fine work and keeps a schedule with Hawaii. We welcome W4MY to our midst. He has opened up with considerable pep. W4VC and W4AHX are heard frequently. W4JY is back on the air. W4AHZ is open for traffic or rag chewing. W4GP pounds the brass once in a while. W4AIY is showing decided signs of activity. After an absence of three years, W4AJY, ex5ACM has come to the front. W4AIB is handling the school traffic at Auburn. W4TI is on consistently. W4FN has taken a position with RCA at Rocky Point. W4VX is getting good reports. W4AHY is the proud owner of a new car, but hasn't let it lull his enthusiasm in radio. Congratulations to W4AHO who recently married. In behalf of the gang, I wish to thank Alex for the fine work he has done as SCM. W4AHR is handling a bunch of traffic. W4AAQ has moved and is open for traffic and rag chewing. W4AHP is one of Montgomery's most consistent workers. W4AJY is a new one in our midst. We regret the loss of W4AIP who has given up the game. He has long been an ardent worker and supporter of the League. Now, fellows, let's get some new life into the section. How about a 100% report next month.

Traffic: W4AJY 57, W4AAH 22, W4AHR 20, W4AIB 25, W4AHY 18, W4AAQ 9, W4MY 8, W4JY 7, W4AJY 5, W4AHP 62.

GA.—S. C.—CUBA—SCM, H. L. Reid, W4KU—Georgia: The stations in this state have come to the front since the Fla. hurricane and have begun to appreciate the real value of the ham station in case of emergencies. W4AJH is quite active now. The SCM is the instructor at the Ga. Tech. Night School and has adopted the Handbook as the text book; South Carolina: W4EI is right here with his regular work and is about the best bet for traffic that way. Porto Rico: We have not heard from the boys there in a good while. Would appreciate a word from one of you.

Traffic: W4AJH 32, W4EI 78, K4AAN 951.  
FLORIDA—SCM, C. E. Ffoulkes, W4LK—W4AII is rebuilding the set. W4AGY is pounding brass. W4HY handles traffic. W4TK made all the continents for WAC. Shoot your traffic to W4AKF, fellows. He says he will take all he can get. W4OO has been rebuilding since returning from the North. W4BN reported by letter. W4ACC is a movie operator in Dunnellon. W4AKQ has been having trouble getting out. W4LK is thinking of moving soon.

Traffic: W4AII 20, W4AGY 18, W4HY 12, W4TK 10, W4AKF 9, W4OO 3.

### WEST GULF DIVISION

**S**OUTHERN TEXAS—SCM, Robert E. Franklin, W5OX—W5AIN leads again this month in traffic as well as DX, having worked all continents this month. W5ASM is doing some nice work with a lone 210. W5ABQ handed in his report at the convention. Glad to see you, OM. W5LP is kicking out well with only 750 volts on his 852. W5AHP has moved again. W5NW is with us from North Texas. He is the new op at KJV, Baytown, and invites the gang to visit him there. Houston has a new ham W5TE of New Orleans. Welcome to our city, OM. W5AIA reports that he will have his station going at Aransas Pass soon. The Houston bunch is getting ready for

some ragchews on 175 meters (1714.3 kc.). FB, OMs.  
Traffic: W5AIN 360, W5ASM 20, W5ABQ 18, W5OX  
8, W5LP 5.

**NORTHERN TEXAS—SCM, J. H. Robinson,**  
W5AKN—Now that all of us have met one another  
at the big convention, we can become re-acquainted  
over the air. W5HY is keeping schedules with  
W5AFW, W5AIN, W9EQE, and W5AMO in the 7500  
kc. band and as usual heads the traffic list. W5BBF  
is using portable call W5RH at school. W5APB re-  
ports for the Amarillo bunch. W5QE is a new station  
there and W5WX is building a 160 meter fone set.  
W5AAE won the theory book at the convention. W5LC  
uses 90 volts on the plate of a 201A on 1850 kc.  
W5ATZ is busy with a new 1929 transmitter. W5WW  
and W5AKN—W5BG are also rebuilding. W5DF re-  
ports. We are in need of a Route Manager. Let's  
hear from some of you fellows. It's a nice job and  
well worth having. W5NW moved to South Texas. He  
always sent in his reports on time, and we will miss  
him greatly. W5BAD reports DX good down his way.  
W5OE is building his transmitter to cover the 3500 kc.  
band.

Traffic: W5HY 35, W5BBF 10, W5APB 8, W5AAE  
7, W5ATZ 6, W5AQ 6, W5WW 6, W5AKN 6, W5BAD  
3, W5OE 3, W5NW 1, W5JX 2, W5DF 1, W5JD 1.

**OKLAHOMA—SCM, J. G. Morgan, W5AMO—**The  
air is tingling with activity around this neck of the  
woods. The favorite pastime seems to be the old fash-  
ioned rag-chewing contest. W5APG reports a total  
of 57 messages this month. W5APG is the com-  
manding officer of the Okla. section of the U. S.  
Naval Reserve. Two recruits are about to be added as  
this goes to press, namely: W5AMO and W5FJ.  
W5AYO is managing the oscillations emanating from  
KGF. W5ANT is nurse maid, janitor and assistant  
manager of KGCB. W5ANT keeps regular schedules  
with W5FJ every day at noon so that "FJ" can keep  
his folks informed on his education at "O. U." W5QL  
is working fo-A50 like nobody's business! W5BCL  
is about to loosen the old fist up and reports working a  
"1", believe it or not! W5ZAV is still held up for  
lack of high voltage for the final pa. W5VH reports  
terrific QRM from the YLs. W5AFX is still grieving  
the loss of the 250. W5PJ is using an 852 now. W5OH  
has a new 1929 receiver.

Traffic: W5AMO 207, W5FJ 136, W5APG 57,  
W5AYO 73, W5VH 25.

## Canada

### ONTARIO DIVISION

**ONTARIO—SCM, E. C. Thompson, VE3FC—**Central  
Dist: VE3DY, our RM, is very active and altho  
bothered a good deal by BCLs, manages to keep  
his schedules and his scalp. VE3CJ is now on the  
air at Powassan, near North Bay, Ont. VE3BP re-  
ports activity on 14,000, 7000, and 5700 kc. VE3ED  
at the Central Tech. School is going strong during  
noon hours every day. VE3BL is doing his best to get  
his mercury arc rectified signals on the air. VE3BO  
clicked with VE4IO of Calgary in daylight. VE3CL  
has changed his QRA and for the better. VE3BC is  
keeping regular skeds. VE9AL is known to be on  
the air at least once each day. VE3FC uses 5700 kc.  
Southern Dist: VE8AY is making things hum on the  
air around Niagara-on-the-Lake on about 7300 kc.

Traffic: VE3DY 24, VE3BC 23, VE3CJ 20, VE8AY  
19, VE9AL 17, VE3BP 1, VE3BO 1, VE3BL 8.

### QUEBEC DIVISION

**QUEBEC—SCM, Alex Reid, VE2BE—**The booth  
which this section had at the Montreal Radio Show  
was a real success. As transmission and reception  
was very poor in the Hotel, the boys took the traffic  
home and handled it from their own station. The  
SCM wishes to thank the following who so kindly  
loaned apparatus and donated prizes for the Show.  
Shawinigan Water & Power Co., L. R. McDonald,  
Burgess Battery Co., Canadian National Carbon Co.,  
Harry Sloan, J. A. Adam, and F. W. Heavysege.  
VE2AC turns in the best traffic report. He expects  
to have a 160 meter transmitter on the air shortly  
to aid the members of his local club. VE2AX has  
rebuilt one of his transmitters. VE2CA is still pound-  
ing away at DX. VE2AP reports many foreign  
contacts during the month. VE2HV has erected a new  
aerial. VE2BE still keeps his sked with oa-2AE and  
is also working the Byrd Expedition boats. VE2BH  
is back from the North and is getting out well on 14  
mc.

Traffic: VE2AC 44, VE2BB 33, VE2AM 24, VE2BR  
34, VE2BE 23.

### VANALTA DIVISION

**BRITISH COLUMBIA—SCM, E. S. Brooks, VE5BJ**  
—VE5GO puts in a good traffic total. VE5AL has  
skeds on 3500 with VE5BR and VE5CT. VE5BR has  
opened up again and wants skeds on 7000 and 3500.  
VE5HK is on the air again. VE5CJ works regularly  
on 7000 and 14,000. W9CKF paid a visit to VE5CO.  
Will amateur using the call sign VE5DT kindly send  
the SCM his QRA—have a flock of QSL cards for  
you. Say, fellows, how about everyone sending in a  
report each month on your activities?

Traffic: VE5GO 60, VE5CO 24, VE5BR 19, VE5AL  
17, VE5CJ 2.

**ALBERTA—SCM, E. J. Taylor, VE4HA—**Most of  
the gang are brushing up to meet 1929 conditions.  
VE4AH has moved to a new location and is putting  
up new poles, VE4BV is on regularly. VE4CL is  
back at University. VE4CU is moving to new loca-  
tion. VE4HA is on 14,000 all the time. VE4HM is  
on regularly. VE4FL is the most consistent of the  
bunch, lately. VE4FF gathers in W9XL right along.  
Let's have some dope, boys—we can't write without  
it.

### PRAIRIE DIVISION

**MANITOBA—SCM, D. B. Sinclair, VE4FV—**VE4CT  
makes first successful 25 mc. tests in this section,  
working six "W" stations on that wave on Oct. 21  
with reports of R5 to R7. It looks like a gala year  
for the Prairie Division. All dead ORS in this divi-  
sion are hereby cancelled and a fresh start is being  
made. VE4EK and VE4FV are the only two still  
retaining their certificates. Three new ones are in  
line, however, namely VE4DB, VE4DJ and VE4FN.  
FB. OBS appointments have also been requested by  
VE4DB, VE4DP and VE4FN. VE4GQ has changed  
his QRA. VE4DI has just completed his new trans-  
mitter and gets crystal control reports. Our old  
friend, VE4BP is back on the air again. VE4FV's  
852 is perking at last. VE4FN got married. VE4DU's  
UX222 is bringing them in FB. VE4DK keeps a  
weekly schedule with W9FYP. VE4HN is the official  
call of ex-4NR. One of our most active stations is  
VE4DB. VE4EK is on 14 mc. exclusively. VE4BU's  
set has been causing him trouble. VE4AR has re-  
built to the TPTG circuit. VE4DJ is on all the time  
on 14,000 and 7000 kc. VE4DP bought a Rectobulb  
but still gets AC reports. VE4DL and VE4GI seem  
to be too busy to do much hamming. A local QSO  
party on 52 meters every Sunday afternoon has been  
commenced. Several new stations are building trans-  
mitters now and it looks like a bumper year for the  
Division.

Traffic: VE4DK 5, VE4HN 4, VE4DJ 7, VE4DB 1,  
VE4EK 2, VE4FV 6.

**SASKATCHEWAN—SCM, W. J. Pickering, VE4FC**  
—The SCM reports the lack of a report for this sec-  
tion last month but the gang will excuse me, I know.  
All the gang visited are getting back on 52.51 and  
rebuilding their transmitters and receivers for 1929  
operation. VE4CM is using TGTP now and wants the  
Winnipeg gang to help him in moving traffic east.  
VEGR is on at noon. VE4BM has a new Zepp.  
VE4IH is back on for the winter and ready for skeds  
in all directions. Ed. Swain at Moose Jaw, is on the  
air as VE4HL. VE4GO is on every noon. The Regina  
gang are very active and have quite a number of sta-  
tions operating. VE4AO has had no luck yet in getting  
going. VE4AI and VE4GW are going to work together  
this winter. VE4FC has been rebuilding. VE4FH is  
still going good. VE4AC has moved to Winnipeg.

Traffic: VE4CM 14, VE4GR 10.

### LATE AND ADDITIONAL REPORTS

W9DXG worked Australia last month. W6BAX  
says 14,000 kc. seems to be good every two weeks.  
HL. W5TV keeps skeds with W9BSM and W9FUY.  
W5DSP has moved to Syracuse. He is building a  
high C in preparation for 1929. W9AOK is back  
on the air again with a new transmitter and a  
mercury arc. W8MQ made the BPL this month  
with a fine total. Keep it up, OM. W8AEI's call is  
now W3MH and QRA is 4686 Kernwood Ave., Balti-  
more, Md.

Traffic: W8MQ 386, W9DXG 33, W6BAX 10, W5TV  
24, W8DSP 11, W9AOK 1. W5OM reported by radio  
this month with quite a few messages handled.  
W9BHF is on 14,000 kc. now. He reports that W5QO  
is at school in Webster, Mo. now and is obtaining  
a 9th dist. call. W9AAO has taken a commercial  
job on the lakes and is QRT. W9BHF is mostly QRT  
for lack of rectifier.

Traffic: 47, W9BHF 12.



**QST**



A Magazine Devoted Exclusively to the Radio Amateur

## INDEX TO VOLUME XII

---

*1928*

---

Published as a supplement to QST  
for December, 1928, Vol. XII, No. 12

Copyright 1928 by The American Radio Relay League, Inc., Hartford, Conn.

# INDEX TO VOLUME XII

1928

## AMATEUR RADIO STATIONS

nulXV-1XAN, Round Hill, South Dartmouth, Mass.	19, July
nu3CAB, Washington, D. C.	39, Jan.
nu40C, Durham, N. C.	37, March
nu6AM, Long Beach, Calif.	43, Feb.
nu6CMQ, Altadena, Calif.	29, May
nu8CPC, Buffalo, N. Y.	37, June
nu8DFO, Wheeling, W. Va.	33, April

V, Jan.  
V, Feb.  
III, March

48, May  
50, July  
IV, Oct.  
VII, Dec.

## AMATEUR REGULATIONS AND LEGISLATION

Amateur Calls Changing	35, Aug.
Amateur Television Waves	8, Oct.
Changes in the Radio Division	27, Feb.
Danger! Take Heed! (Handy)	IV, Jan.
Editorials: 7, March; 7, April; 7, August; 7, Sept.; 7, Oct.	
Extracts from the Washington Convention	28, Feb.
1929 Abbreviations	41, Oct.
Municipal Ordinances on Radio Transmission Unlawful (Budlong)	26, Jan.
New Station Licenses	33, Jan.
New Phone Regulations (Editorial)	3, Feb.
Recent Changes in Radio Law and Regulations	14, May
Renewal of Licenses (Stray re:)	8, June
The Amateur and the International Radiotelegraph Conference (Warner)	15, Jan.
Washington Developments (K. B. W.)	43, Sept.

## AMPLIFIERS—AUDIO AND RADIO

A General Purpose Device (Chinn)	12, Jan.
Double-Detection Receivers with Band-Pass Filters and Screen-Grid Amplifiers (Taylor)	9, March
Practical Audio Filters (Hatry)	19, May
Regenerative Coupling Devices in Audio Amplifiers (Clapp)	37, Dec.
The Helpful Audio Filter	37, Jan.
The Oscillator-Amplifier Transmitter (Hull)	9, Sept.
The UX-222 as a Short-Wave Amplifier (Lidbury)	44, April

## ANTENNA SYSTEMS

An Effective Antenna Tuning System (Bourne)	36, Aug.
Directional Properties of Transmitting and Receiving Antennae (Clapp and Chinn)	19, Feb.
High Angle Radiation (Hendricks)	31, Oct.
Matching the Transmission Line to the Antenna (Roberts)	43, Jan.
Reducing the Cuss Quotient (Paddon)	44, July
Tests on a Method of Voltage Feeding the Antenna (Fuchs)	37, July
The Zepp (Lamb)	33, Sept.
What Length Antenna (Lamb)	49, Oct.

## ARMY AMATEUR

A New Chief Signal Officer	17, Feb.
Army-Amateur Activity in the Philippines	31, Aug.
The Army-Amateur Transmitter W1WF (Goldsmith and Cullum, Jr.)	19, Dec.
Army-Amateur Notes:	

Page numbers in Roman Numerals refer to Communications Department in issue indicated

## BATTERIES AND BATTERY SUBSTITUTES

Filament Supply Progress (Halligan) .....39, July

## BETTER OPERATING PRACTICES

About That W	1, Dec.
Amateur Status (F.E.H.)	48, June
A Message Handling System (Lampkin)	40, Dec.
Another Bawling Out (Turner)	49, Aug.
Danger! Take Heed! (Handy)	IV, Jan.
1929 Abbreviations	41, Oct.
"If You Only Try—" (Budlong)	41, March
Investment (L.R.H.)	IV, Oct.
Operating Procedure that Gets Results (Storck)	48, Aug.
Rotten Sending (Barker)	VII, Sept.
Secrecy of Messages (F. E. H.)	47, July
The Twin City Vigilance Committee (Kohler)	25, May

## BOOK REVIEWS

A Popular Guide to Radio (Dashliel)	84, Aug.
Bible Dramas (Manley)	78, Sept.
Elimination of Inductive Interference in Radio Reception (Smith)	36, March
Emile Berliner, Maker of the Microphone (Wile)	36, March
Everyman's Guide to Radio (Yates)	64, Jan.
Lefax Radio Handbook	64, Jan.
Les Ondes Electriques Courtes (Mesny)	64, Jan.
Methods, Formulas and Tables for the Calculation of Antenna Capacity (Grover)	81, Aug.
National Electrical Safety Code	84, Aug.
Practical Radio Telegraphy (Nilson and Hornung)	36, March
Practical Television (Larner)	76, Sept.
Storage Batteries Simplified (Page)	78, Sept.
Wireless Direction Finding and Direction Reception (Keen)	36, March

## BREAK-IN AND REMOTE CONTROL

(See: RELAYS)

## CALLS HEARD

53, Jan.	61, July
57, Feb.	61, Aug.
55, March	51, Sept.
59, April	50, Oct.
61, May	43, Nov.
57, June	50, Dec.

## CHOKES

Additional Notes on Iron-Core Reactances (Repleke)	46, Aug.
Choke Coil Design (Wareing)	29, Dec.
Choke Coil Notes	Exp. Section, Nov.

Measuring the Inductance of an Iron-Cored Choke at Different Currents (Katzman) . . .30, Feb.  
 Notes on the Design of Iron-Core Reactances Which Carry Direct Current (Replogle) . .23, April  
 Notes on the Design of Radio Frequency Chokes (Clough) . . .29, June  
 Notes on Filter Circuit Design (Replogle and Millen) . . .27, July  
 Practical Audio Filters (Hatry) . . .19, May  
 Radio Frequency Chokes for Receivers (Browning) . . .31, Jan.  
 Use of a Non-Magnetic Meter for Testing R. F. Chokes . . .Exp. Section, May

**COILS**

All About the Tube-Base Receiver (Quinby) . . .35, March  
 A Mounting for Space-Wound Coils (Pigford) . . .45, July  
 The Spaced-Turn Coil (Binneweg, Jr.) . . .34, June

**CONDENSERS**

A New Condenser . . .86, Nov.  
 Experimenting with By-Pass Condensers (Rider) . . .38, Nov.  
 Filter Condensers . . .Exp. Section, Dec.  
 Mica Condensers for High Frequency (Trogner) . . .47, Sept.  
 Notes on Filter Circuit Design (Replogle and Millen) . . .27, July  
 Picking the Right Filter Condenser (Smith) . .37, Oct.  
 The Design of Variable Condensers for High-Voltage Operation (Smith) . . .49, March  
 The Final Capacity in a Two-Section Low-Frequency Filter (Replogle and Millen) . .36, Feb.  
 The Middle Capacity in a Two-Section Power Supply Filter (Millen and Replogle) . . .27, May  
 Variable Transmitting Condensers . . .14, Feb.

**CONTESTS**

Another Traffic Trophy! . . .III, Feb.  
 Army Amateur Contest Report . . .VII, Sept.  
 English QRP Tests Announcement . . .46, June  
 International Tests:  
 Notes on . . .51, Jan.  
 List of Prizes . . .33, Feb.  
 Final Report of Winners . . .38, Aug.  
 Scandinavian-American Short-Wave Contest announcements . . .I, Sept.; I, Oct.  
 The Roberts Cup:  
 Announcement and conditions . . .45, June  
 Announcement of Winners . . .II, Sept.  
 Navy Day Competition:  
 Announcement and conditions . . .I, Oct.  
 Report and Honor Roll . . .III, Dec.

**CONVENTIONS**

Atlantic Division Convention: Ann. . . .38, May  
 Report on . . .88, Aug.  
 Central Division (Ohio) Convention: Ann. . .47, Aug.  
 Report on . . .19, Oct.  
 Central Division (Wisconsin) Convention:  
 Ann. . . .18, May  
 Report on . . .82, Aug.  
 Central Division (Michigan) Convention:  
 Report on . . .86, July  
 Central Division (Indiana) Convention report . . .80, Sept.  
 Hudson Division Convention report . . .31, July  
 Midwest Division (Kansas) Convention:  
 Ann. . . .8, Oct.  
 Report on . . .45, Dec.  
 Midwest Division (Iowa) Convention:  
 Ann. . . .34, March  
 Report on . . .28, June  
 New England Division Convention: Ann. . .36, March  
 Report on . . .42, June  
 New England Division Convention (Maine Section): Ann . . .12, July

Report on . . .82, Sept.  
 North Carolina Roanoke Divn. Convention:  
 Ann. . . .19, Feb.  
 Report on . . .90, May  
 Northwestern Division Convention: Ann . .42, Aug.  
 Report on . . .40, Nov.  
 Pacific Division Convention announcement . .24, Sept.  
 Rocky Mountain Division Convention:  
 Ann . . .17, Aug.  
 Report on . . .30, Oct.  
 South Dakota Convention report . . .55, Feb.  
 Southeastern Division Florida Convention:  
 Ann . . .38, Jan.  
 Report on . . .70, March  
 Vanalta Division Convention . . .18, July  
 West Gulf Division Convention: Ann . . .32, Feb.  
 Report . . .88, April

**EDITORIALS**

(Page 7 of each issue with exception noted below)  
 Page 9, January.

**EMERGENCY AND RELIEF WORK**

Amateur Radio Work in New England Flood (Boyd and Russell) . . .I, Jan.  
 Editorial . . .7, Nov.  
 Emergencies—Are You Ready? . . .I, Dec.  
 Hurricanes and Amateur Radio (Huber) . . .II, Nov.  
 Priority in Emergencies (F. E. H.) . . .II, Nov.  
 Santa Paula Flood Work (6CZR and 6AM) . .46, May

**EXPEDITIONS**

Byrd—WFA: . . .I, Sept.; III, Oct.  
 WFBT: . . .III, Nov.; IV, Dec.  
 Communication with VOQ (Heiser) . . .I, March  
 Following the "Southern Cross" to Brisbane (Frates) . . .21, Aug.  
 GMD Reports:  
 II, Feb. . . .45, June  
 46, April . . .48, July  
 III, Oct.  
 KDZ: . . .46, April; 45, June  
 MacMillan and Party in Labrador (Rodimon) . . .15, Feb.  
 NITB: . . .50, Aug.; II, Sept.  
 Radio on the Byrd Expedition . . .47, Dec.  
 VCB: . . .45, June  
 VDE and the Hudson Straits Expedition (Starr) . . .11, March  
 VOQ: . . .45, June; 48, July; III, Oct.; III, Nov.  
 VOQ Contact . . .V, Dec.  
 WNP:  
 IV, Feb. . . .48, July  
 47, April . . .II, Sept.  
 48, May . . .II, Oct.  
 Rockford-Sweden KHAH: . . .46, June; 48, July  
 WSBS: . . .46, June; 49, July; II, Sept.; III, Oct.; IV, Nov.; IV, Dec.

**EXPERIMENTERS SECTION**

January, page 48:  
 Standard frequency transmitters  
 Five Meter Reports  
 Concerning Television  
 February, page 39:  
 Standard Frequency  
 The 5-Meter Experimental Station 9EHT (Douglas)  
 The Worthwhile 5-Meter Wave (Douglas and Kruse)  
 March, page 52:  
 A Portable Transceiver (Radloff)  
 April, page 44:  
 The UX-222 as a Short-Wave Amplifier (Lidbury)  
 May, page 41:  
 Use of a Non-Magnetic Meter for Testing R.F. Chokes

June, page 41:	The Keying Problem Concerning Those Short Waves
September, page 46:	Concentrating on Problems to Meet 1929 Con- ditions
November, page 39:	Electrolytic Rectifiers Keying R. F. Chokes
December, page 46:	A Chronograph Relay Ten-Meter Transmitter Reflectors Telephone Ringing Interference Neon Tube Audio Oscillators Filter Condensers

## FICTION

Meow R-r-r-9 (Ma).....	35, June
Rotten Bunk (The Old Man).....	42, Jan.
Rotten DX (The Old Man).....	16, May
The Fifth Age (Adams).....	37, Sept.

## FILTERS

(See also: "Chokes" and "Condensers")

Acoustic Wave Filters and Audio Frequency Selectivity (Bourne).....	23, Aug.
Double Detection Receivers with Band-Pass Filters and Screen-Grid Amplifiers (Taylor).....	9, March
Filter Circuits (Farrar).....	48, Aug.
"If You Only Try—" (Budlong).....	41, March
Notes on Filter Circuit Design (Replogle and Millen).....	27, July
Picking the Right Filter Condenser (Smith).....	37, Oct.
Practical Audio Filters (Hatry).....	19, May
The Final Capacity in a Two-Section Low- Frequency Filter (Replogle and Millen).....	36, Feb.
The Middle Capacity in a Two-Section Power Supply Filter (Millen and Replogle).....	37, May
The Helpful Audio Filter.....	37, Jan.

## I. A. R. U.

Editorial ..... Dec.

I.A.R.U. Department:

52, Jan.	60, July
56, Feb.	60, Aug.
54, March	50, Sept.
58, April	51, Oct.
60, May	44, Nov.
56, June	51, Dec.

## METERS

(See also: "Wavemeters, Frequency Meters and  
Oscillators")

A Combination Fieldmeter-Wavemeter-Volt- meter (Woodruff).....	39, May
Building a Wattmeter (Iverson).....	27, June
Now—the Vacuum-Tube Ammeter (Hatry).....	44, Dec.

## MISCELLANEOUS

Another Part of the Family.....	33, May
Another Way of Playing an Old Prank (Turner).....	41, Nov.
Concerning Lunar Effects on Electromag- netic Waves (Pickard).....	20, Aug.
Designing Fixed Resistors (Hitchcock).....	29, April
Election Notices:.....	49, Sept.; 32, Oct.
Election Results.....	11, Jan.
Fading on Short Waves at Long Distances (Gherzi).....	31, June
Financial Statements:	

62, Jan; 40, April; 25, June; 80, Sept.; 80, Dec.	Frequency Stability by Magnetostriction
Oscillators (Westman).....	21, Nov.
Lunar Effects on Electromagnetic Waves (Paulson).....	38, June
"Now We're in the Air" (Wiggins).....	33, Nov.
Odd Jobs (Lampkin).....	34, Nov.
Resistors.....	27, Feb.
s5BX (Foster).....	18, Nov.
Some Changes at Headquarters.....	23, May
Some Investigations of Short Waves at Nijni- Novgorod (Grzybowski).....	9, April
Some Overlooked Possibilities for the Radio Club (Pancost).....	26, June
Some Radio Uses of Lamp Banks (Iverson).....	42, Nov.
Shielding Efficiency of Metals (Mason).....	28, Feb.
Straight Edge Solutions.....	26, Dec.
The DX Tape Measure (Babcock).....	47, March
The "Good Old Days".....	8, Dec.
Two Inexpensive Test Sets (Palmer).....	32, March
Visual Radio and Its Possibilities (Ausman).....	48, Oct.
We Grow.....	22, Feb.
We Ought to Talk Frequency.....	19, Sept.
What is Amateur Radio? Traffic (Segal).....	18, July

## NAVY AMATEUR

Navy Day Competition: Announcement.....	I, Oct.
Report and Honor Roll.....	
The U. S. Naval Communication Reserve in Florida (Lee).....	IV, Sept.

## OBITUARY

Admiral Bullard Dies.....	47, Jan.
Horace A. Beale, Jr.,.....	36, Jan.

## OFFICIAL BROADCASTING STATIONS

Changes and Additions:	
V, Jan.	47, May
III, March	VI, Dec.
Full List.....	VI, Feb.
Full List with Schedules.....	V, Oct.

## PROSPECTING BY RADIO

Electrical Prospecting (Jakosky).....	9, June
Radio Applied to Petroleum Prospecting (Chinski).....	43, March

## RECEIVERS — BROADCASTING A LONG- WAVE

An Improved Super-Heterodyne (Grigg).....	23, Dec.
Another Code Learning Set (Westman).....	33, March
A Short and Medium Wave Receiver (Coston).....	19, June
A Single-Control Device (Danley).....	24, Feb.
Double Detection Receivers with Band-Pass Filters and Screen-Grid Amplifiers (Taylor).....	9, March

## RECEIVERS—GENERAL

Acoustic Wave Filters and Audio Frequency Selectivity (Bourne).....	23, Aug.
A Frequency Meter Combined with the Re- ceiver (Woodruff).....	41, Dec.
A General Purpose Device (Chinn).....	12, Jan.
A Mounting for Space-Wound Coils (Pigford).....	45, July
An Effective Antenna Tuning System (Bourne).....	36, Aug.
A Resonance Testing Method (Teachman).....	41, July
Practical Audio Filters (Hatry).....	19, May
Radio Frequency Chokes for Receivers (Browning).....	31, Jan.
Receivers Characteristics and their Measure- ments (Landon).....	23, Oct.
The Helpful Audio Filter.....	37, Jan.
The Space-Turn Coil (Binnewig, Jr.).....	34, June
The Unimportance of Short Leads (Hatry).....	45, Jan.
Variable A—, B—, and C— Power from DC Mains (Anderson).....	48, April



## RECEIVERS—SHORT WAVE

All About the Tube-Base Receiver (Quinby)	35, March
A Portable Receiver (Lamb)	41, April
A Short and Medium Wave Receiver (Coston)	19, June
A Super-Regenerator for Short Waves (Hart)	32, July
A Super-Heterodyne for High Frequencies (Gluck)	20, Oct.
Double Detection Receivers with Band Pass Filters and screen Grid Amplifiers (Taylor)	9, March
Easy Tuning in Short Wave Bands (Lidbury)	39, April
Getting Started on 160 Meters (Westman)	46, Oct.
High Frequency Receivers for the Coming Year (Hull)	9, Nov.
Remodeling the traffic Tuner for 1929 (Westman)	39, Sept.

## RECTIFIERS

Electrolytic Rectifiers	Exp. Section, Nov.
The Duriron-Duralumin Electrolytic Rectifier (Woldman)	45, Oct.

## RELAYS

A Chronograph Relay	Exp. Section, Dec.
Keying for Break-In (McCormick)	23, June
Relays for the Amateur (Lampkin)	33, July
Remote Control Relay (Fixman)	23, Dec.

## STANDARD FREQUENCY TRANSMISSIONS

Experimenters Section	Jan.
Standard Frequency Stations Needed	42, Aug.
Std. Frequency Schedules:	
25, Jan.	8, July
14, April	8, Sept.
23, April	8, Nov.
8, June	42, Nov.
Official Frequency Stations:	
55, Feb.	40, May
42, March	36, July
8, April	68, Nov.

## TELEVISION

Amateur Television (Thomsen)	17, May
Amateur Television Waves	8, Oct.
Experimenters Section	Jan.
Radiovision (Dewhurst)	15, Sept.
Some More About Amateur Television (Westman)	30, Aug.
Synchronism (Jenkins)	33, Sept.

## TEN AND FIVE METERS

About 28-mc (10-meter) Work	I, Oct.
About 28-mc (10-meter) Work	IV, Nov.
About 28-mc (10-meter) Work	1, Dec.
Concerning Those Short Waves	Exp. Section, June
Five Meter Reports	Exp. Section, Jan.
Flash 1-10-meter Results	1, Feb.
Flash 1-10-meter Results	1, Dec.
Experimenter Section notes	Jan. Feb.
Getting Started at 30 Megacycles (Kruise)	9, May
High Angle Radiation (Hendricks)	31, Oct.
More Ten Meter Tests	51, Aug.
28,000 Kilocycles—and How! (Westman)	37, Aug.
The 5-meter Experimental Station 9EHT (Douglas)	Exp. Section, Feb.
The Worthwhile Five-Meter Wave	Exp. Section, Feb.

Ten Meters	14, June
	1, Sept.
Ten-Meter DX Party Coming	46, May
Ten Meters and the Ultraudion (McCormick)	11, May
Ten Meter Results!	59, July
The Ten Meter Tests	59, July

## TRANSMITTERS—CIRCUITS AND CONSTRUCTION

(See also: "Ten and Five Meters")	
Adapting Medium and High-Power Self-Excited Transmitters to 1929 Service (Hull)	25, Sept.
A Portable Transceiver (Radloff)	Exp. Section, March
Designing Small Transformers (Hitchcock)	44, May
"If You Only Try—" (Budlong)	41, March
Keying for Break-In (McCormick)	23, June
6AM (Wallace and Kruse)	45, Feb.
Keying Master Oscillator Circuits (Dudley)	37, April
Overhauling the Transmitter for 1929 (Hull)	9, Aug.
Push-pull Transmitters (Lamb)	13, Dec.
The Oscillator-Amplifier Transmitter (Hull)	9, Sept.

## TRANSMITTERS—CRYSTAL CONTROL

A Crystal Grinder (Mason)	37, May
A Portable Crystal Controlled Transmitter (Angus)	38, Oct.
A 28-Megacycle Crystal Controlled Transmitter (Chian)	29, Nov.
Debunking Crystal Control (Hollister)	35, Dec.
Grinding of Quartz Plates (Watts)	27, Jan.
Low-Power Flexible Crystal Control for Four Amateur Bands (McMinn)	15, April
The Construction of a 3500-Kc. Crystal Controlled Phone (Springer)	9, Dec.

## TRANSMITTERS—LOW POWER

A Low-Power Master-Oscillator Transmitter (Dudley)	10, Feb.
A Transmitter Without Transformers (Harty)	28, April
160-Meter Low-Power Transmitter (Hart)	37, Nov.
Low-Power Flexible Crystal Control for Four Amateur Bands (McMinn)	15, April

## TRANSMITTERS—PHONE

A Phone Transmitter for the Beginner and Advanced Amateur (Tanner)	23, July
Concerning Amplifier Absorption Modulation (Juste)	42, July
The Construction of a 3500-Kc Crystal Controlled Phone (Springer)	9, Dec.
This Amateur Phone Business (Lackey and Spencer)	23, Jan.

## TRANSMITTING—GENERAL

A Portable Power Supply (Sturm)	34, Jan.
Cheap "Neon" Lamps and How to Use Them (Huddy)	20, Feb.
Dog-Day Doldrums (Hull)	18, Feb.
Reducing the Cuss-Quotient (Paddon)	44, July
Some Notes on a Visit to the Naval Research Laboratory (Hull)	9, July
Some Suggestions for 1929 (Walleze)	27, Nov.
Transmitting Hints:	32, Oct.; 88, Nov.

## TUBES

Cheap "Neon" Lamps and How to Use Them (Huddy)	20, Feb.
Some Special Uses of the UX-222 (Westman)	49, Jan.
The UX-222 as A Short-Wave Amplifier (Lidbury)	Exp. Section, April

The UX-250-CX-350 Tube ..... 36, April  
The UX-860 (Westman) ..... 31, Sept.

A Frequency Meter Combined with the  
Receiver (Woodruff) ..... 41, Dec.  
A General Purpose Device (Chinn) ..... 12, Jan.  
A Resonance Testing Method (Teachman) 41, July  
A Simple High-Frequency Oscillator  
(Christie) ..... 43, July  
Some Suggestions for the Monitor  
(Grammer) ..... 43, Dec.  
The Frequency Measurement Problem (Hull) 9, Oct.

**WAVEMETERS, FREQUENCY METERS  
AND OSCILLATORS**

A Combination Fieldmeter-Wavemeter-Volt-  
meter (Woodruff) ..... 39, May

Page numbers in Roman Numerals refer to Communications Department in Issue indicated